

# Installation and Configuration Manual for VMP3-based\* Instruments

**\*VMP3-based instruments are:**

- ✓ **SP-50**
- ✓ **SP-150**
- ✓ **VSP**
- ✓ **VMP3**
- ✓ **Bistat**
- ✓ **EPP-4000**
- ✓ **HCP series**
- ✓ **CLB series**





# Certificate of Conformity

We certify that all goods detailed below have been inspected and tested, and unless otherwise stated conform with the order of the customer, the drawings and specifications of **Bio-Logic Science Instruments SAS**.

*Instruments used to calibrate these equipments are traceable to the NIST Standards.*

*CE certificates available in paragraph 12.*

---

<b>Model</b>	<b>Serial number of the chassis</b>
<input type="checkbox"/> <b>SP-50</b>	
<input type="checkbox"/> <b>SP-150</b>	
<input type="checkbox"/> <b>VSP</b>	
<input type="checkbox"/> <b>VMP3</b>	
<input type="checkbox"/> <b>Booster chassis</b>	
<input type="checkbox"/> <b>HCP-803/80A booster</b>	
<input type="checkbox"/> <b>HCP-1005/100A booster</b>	
<input type="checkbox"/> <b>CLB-500/LB-500</b>	
<input type="checkbox"/> <b>CLB-2000/LB-2000</b>	

---

**Firmware of EC-Lab®: .....**

Signed, for and on behalf of Bio-Logic Science Instruments SAS:

Date:



## **Equipment installation**

**WARNING!** The instrument is safely grounded to the Earth through the protective conductor of the AC power cable.

Use only the power cord supplied with the instrument and designed for the good current rating (10 Amax) and be sure to connect it to a power source provided with protective earth contact.

Any interruption of the protective earth (grounding) conductor outside the instrument could result in personal injury.

### **General description**

The equipment described in this manual has been designed in accordance with EN61010 and EN61326 and has been supplied in a safe condition. The equipment is intended for electrical measurements only. It should be used for no other purpose.

### **Intended use of the equipment**

The instrument is an electrical laboratory equipment intended for professional and intended to be used in laboratories, commercial and light-industrial environments. Instrumentation and accessories shall not be connected to humans.

### **Instructions for use**

To avoid injury to an operator the safety precautions given below, and throughout the manual, must be strictly adhered to, whenever the equipment is operated. Only advanced user can use the instrument.

Bio-Logic SAS accepts no responsibility for accidents or damage resulting from any failure to comply with these precautions.

### **Grounding**

To minimize the hazard of electrical shock, it is essential that the equipment be connected to a protective ground through the AC supply cable. The continuity of the ground connection should be checked periodically.

### **Atmosphere**

You must never operate the equipment in corrosive atmosphere. Moreover if the equipment is exposed to a highly corrosive atmosphere, the components and the metallic parts can be corroded and can involve malfunction of the instrument.

The user must also be careful that the ventilation grids are not obstructed on the right and left sides and under the chassis. An external cleaning can be made with a vacuum cleaner if necessary.

Please consult our specialists to discuss the best location in your lab for the instrument (avoid glove box, hood, chemicals ...).

## Avoid Unsafe Equipment

The equipment may be unsafe if any of the following statements apply:

- Equipment shows visible damage,
- Equipment has failed to perform an intended operation,
- Equipment has been stored in unfavourable conditions,
- Equipment has been subjected to physical stress.

In case of doubt as to the serviceability of the equipment, don't use it. Get it properly checked out by a qualified service technician.

### Live Conductors

When the equipment is connected to its measurement inputs or supply, the opening of covers or removal of parts could expose live conductors. Only qualified personnel, who should refer to the relevant maintenance documentation, must do adjustments, maintenance or repair

### Equipment Modification

To avoid introducing safety hazards, never install non-standard parts in the equipment, or make any unauthorised modification. To maintain safety, always return the equipment to Bio-Logic SAS for service and repair.

## In Case Of Problem

Information on your hardware and software configuration is necessary to analyze and finally solve the problem you encounter.

If you have any questions or if any problem occurs that is not mentioned in this document, please contact your local retailer. The highly qualified staff will be glad to help you.

Please keep information on the following at hand:

- Description of the error (the error message, mpr file, picture of setting or any other useful information) and of the context in which the error occurred. Try to remember all steps you had performed immediately before the error occurred. The more information on the actual situation you can provide, the easier it is to track the problem.
- The serial number of the device located on the rear panel device.

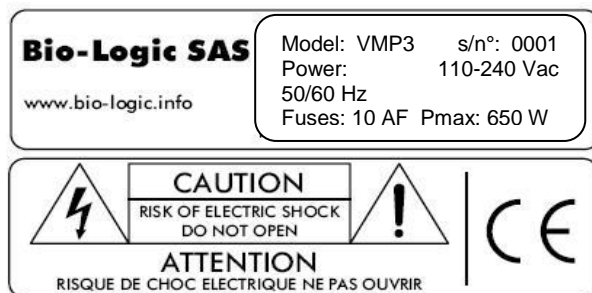

- The software and hardware version you are currently using. On the Help menu, click About. The displayed dialog box shows the version numbers.
- The operating system on the connected computer.
- The connection mode (Ethernet, LAN, USB) between computer and instrument.

## General safety considerations

---



Class I

The instrument is safely grounded to the Earth through the protective conductor of the AC power cable.

Use only the power cord supplied with the instrument and designed for the good current rating (10 A max) and be sure to connect it to a power source provided with protective earth contact.

Any interruption of the protective earth (grounding) conductor outside the instrument could result in personal injury.

---



Warranty and liability claims in the event of injury or material damage are excluded when they are the result of one of the following.

- Improper use of the device,
  - Improper installation, operation or maintenance of the device,
  - Operating the device when the safety and protective devices are defective and/or inoperable,
  - Non-observance of the instructions in the manual with regard to transport, storage, installation,
  - Unauthorised structural alterations to the device,
  - Unauthorised modifications to the system settings,
  - Inadequate monitoring of device components subject to wear,
  - Improperly executed and unauthorised repairs,
  - Unauthorised opening of the device or its components,
  - Catastrophic events due to the effect of foreign bodies.
- 



**ONLY QUALIFIED PERSONNEL** should operate (or service) this equipment.

---

**WARNING!**

- Do not connect the ground lead to a power source from the earth potential greater than +/- 10 Vdc
  - Operate on a non-flammable support
  - Heavy instrument: lift with caution
- 



To prevent exposure to magnetic field created around the cell cable during the experiment at high level of current (higher than 10 A), it is recommended to maintain a distance of 20 cm between user and cable when experiment is running (ICNIRP Guidelines).





**Table of contents**

Certificate of Conformity .....	i
Equipment installation .....	iii
Avoid Unsafe Equipment .....	iv
In Case Of Problem .....	iv
General safety considerations .....	v
<b>1 Introduction of the product range .....</b>	<b>5</b>
1.1 General description .....	6
1.2 Software features .....	7
<b>2 Software installation on the computer .....</b>	<b>9</b>
2.1 EC-Lab <sup>®</sup> software installation .....	9
2.2 EC-Lab <sup>®</sup> Express software/OEM package installation .....	13
2.3 Errors during the installation .....	13
<b>3 PC installation and configuration .....</b>	<b>15</b>
3.1 TCP/IP installation and configuration .....	15
3.2 USB driver installation .....	17
3.2.1 Windows XP installation .....	17
3.2.2 Windows Seven, Eight and Vista installation .....	19
3.2.3 Uninstall USB drivers .....	20
<b>4 Instrument installation .....</b>	<b>23</b>
4.1 Connections .....	23
4.1.1 Direct USB connection .....	23
4.1.2 Direct Ethernet connection .....	23
4.1.3 Network connections .....	23
4.2 Power supply .....	24
<b>5 PC connection to the instrument .....</b>	<b>25</b>
5.1 Network parameter configuration with the Ethernet connection .....	25
5.2 Connection to the computer with EC-Lab <sup>®</sup> software .....	25
5.2.1 Modification of the instrument IP address .....	27
5.3 Connection using EC-Lab <sup>®</sup> Express software .....	28
5.3.1 IP address modification of the instrument .....	30
5.4 Windows Security Alert .....	31
5.5 Firmware Upgrade with EC-Lab <sup>®</sup> software .....	31
5.6 Firmware Downgrade with EC-Lab <sup>®</sup> software .....	31
<b>6 Connection to the cell .....</b>	<b>35</b>
6.1 Cell cable to the potentiostat .....	35
6.1.1 Connection of the standard channel board .....	35
6.1.2 Connection to the cell through a booster or Low current option .....	36
6.1.2.1 Low current option .....	37
6.1.2.2 Booster kit front panel .....	38
6.1.2.2.1 2 A, 4 A and 5 A .....	38
6.1.2.2.2 10 A and 20 A .....	38
6.1.2.2.3 80 A (HCP-803 or booster 80 A) .....	39
6.1.2.2.4 100 A (HCP-1005 or booster 100A) .....	40
6.1.2.2.5 500 W load box (CLB-500 or LB-500) .....	40

6.1.2.2.6	2 kW load box (CLB-2000 or LB-2000)	41
6.2	Cell cable to the cell	42
6.2.1	Standard connection	42
6.2.1.1	Standard three-electrode connection	42
6.2.1.2	Two-electrode connection	43
6.2.1.3	Four-electrode connection	43
6.2.2	CE to Ground connection mode	44
6.2.2.1	CE to Ground with one common reference electrode	44
6.2.2.1.1	The Bipot cable	44
6.2.2.1.2	The N-Stat Box	45
6.2.2.1.2.1	The low current N'stat Box	45
6.2.2.2	CE to Ground mode with N reference electrodes	47
6.2.3	Specific connection for high current boosters and load boxes	47
6.2.3.1	80 A booster	47
6.2.3.2	100 A booster	48
6.2.3.3	500 W load box	49
6.2.3.4	2 kW Load box booster	50
6.3	Auxiliary inputs/outputs (DB9)	50
<b>7</b>	<b>Advanced features</b>	<b>53</b>
7.1	External device control and recording	53
7.1.1	General description	53
7.1.2	Rotating electrodes control	55
7.1.2.1	Connections	55
7.1.3	Temperature control	57
7.1.4	Electrochemical Quartz Crystal Microbalance coupling	57
7.2	Virtual potentiostat	59
<b>8</b>	<b>The accessories</b>	<b>61</b>
8.1	Test boxes for calibration check and user's training	61
8.1.1	Dummy Cell 2 (DC2)	61
8.1.2	Dummy cell for booster	61
8.1.3	Test Box 2	62
8.1.4	Test Box 3	62
8.2	Temperature probe	63
8.3	Battery holders	63
8.3.1	Battery Holder: BH-1	63
8.3.2	Battery Holder: BH-2	63
8.3.3	Coin Cell Holder: CCH-1	64
8.4	Rack	64
8.5	Sensor Adapter Module	65
8.6	The Bipot cable and N-Stat boxes	65
8.7	Labview VIs	65
8.8	Electrochemistry accessories	66
<b>9</b>	<b>Calibration and Maintenance</b>	<b>67</b>
9.1	New boards installation in an existing instrument	67
9.2	Software channel calibration	67
9.3	Equipment maintenance	70

---

<b>10</b>	<b>Technical Specifications</b> .....	<b>71</b>
10.1	Equipment Ratings .....	71
10.1.1	Electrical & Mechanical specifications .....	71
10.1.2	Environmental .....	71
10.2	Specifications .....	72
10.2.1	Channel board .....	72
10.2.2	Low Current (LC) option .....	73
10.2.3	4 A/8 A internal boosters .....	74
10.2.4	2 A/5 A/10 A/20 A boosters to be inserted in the booster chassis .....	74
10.2.5	80 A/ 100 A boosters .....	75
10.2.6	500 W/ 2 kW load boxes .....	76
10.3	PC requirements .....	78
10.4	Safety precautions .....	78
<b>11</b>	<b>Troubleshooting</b> .....	<b>79</b>
11.1	Data saving .....	79
11.2	PC Disconnection .....	79
11.3	Effects of computer save options on data recording .....	79
11.4	Preliminary checks .....	79
<b>12</b>	<b>EC declaration of conformity</b> .....	<b>85</b>
12.1	SP-50/SP-150 .....	85
12.2	VSP/Bistat/EPP-4000 .....	86
12.3	VMP3 .....	87
12.4	External Booster .....	88
12.5	HCP-803/80 A Booster .....	89
12.6	HCP-1005/100 A Booster .....	90
12.7	CLB-500/LB-500 .....	91
12.8	CLB-2000/LB-2000 .....	92
<b>13</b>	<b>Glossary</b> .....	<b>93</b>
	<b>Index</b> .....	<b>95</b>



## 1 Introduction of the product range

Historically, the first potentiostat built by **BioLogic** was a multi-channel instrument. It was designed to study intercalated ion compounds with long experiment times due to slow diffusion coefficients. It worked either in galvanostatic or in potentiostatic mode (each channel was devoted to one mode). Since this time, many improvements have been done and currently, each instrument of the product range is a potentiostats/galvanostats/ZRA (ZRA: Zero Resistance Ammeter). Electrochemical Impedance Spectroscopy (EIS) option can be added as well on each potentiostat/galvanostat/ZRA board.

The first instrument was the VMP3 and all the other derives from the VMP3, this range of instruments' is called **VMP3-based** instruments.

The instruments of the VMP3-based range are developed to be versatile. So, they can cover all the applications of electrochemistry *i.e.* from energy to sensor, corrosion to fundamental electrochemistry...

The instruments consist of a single computer board associated depending on the instrument configuration along with one or several potentiostat/galvanostat/ZRA channel board(s). For example, there is one channel for the SP series, five channels for VSP, and sixteen channels for VMP3... The instrument has its own operating system included into the computer board. Once started, the on-board computer fully controls of the experiment. It is designed to be used as multi-user instrument (several users connected to the same instrument, especially interesting for multichannel device). These computers can be connected to the instrument through an Ethernet or USB connection. All the instruments are controlled by EC-Lab<sup>®</sup> software.

Most of the instruments (except SP-50, EPP) can be coupled with low current board or with current boosters (2, 5, 10, 20, 80, 100 A).



Fig. 1: VMP3.

Moreover, in the case of multichannel instrument, a specific connection (CE to Ground) mode allows user to perform a multielectrode investigations *i.e.* several working electrodes with only one counter electrode and one reference electrode (for simultaneous or synchronized measurements). This connection offers the ability of an electrochemical cell design with multiple working electrodes in the same bath.

The instrument can control auxiliary instruments (rotating electrode or thermostatic bath) and record external signals such as absorbance, rotating speed, temperature, and quartz microbalance variables (resistance and frequency).

The aim of this manual is to guide the user in the instrument's installation and configuration. This manual is composed of several chapters. The first part is a general description of the instruments. The second and third parts describe how to install the software and how to configure the computer. The fourth and the fifth parts concern the installation and configuration of the instrument and how to connect the instrument to the computer. The sixth chapter is dedicated to the cell connection in the different configurations. The seventh chapter is dealing with the advanced features. The accessories are described in the eighth part. Finally calibration, maintenance and specifications are shown in the two last parts.

WHEN AN USER RECEIVES A NEW UNIT FROM THE FACTORY, THE SOFTWARE AND FIRMWARE ARE INSTALLED AND UPGRADED. THE INSTRUMENT IS READY TO BE USED. IT DOES NOT NEED TO BE UPGRADED.

## 1.1 General description

According to the selected instrument, the number of channel and the options (low current (LC)/boosters) are different. The description of the instrument is the following:

**Tab: 1: General description of the instruments.**

Type of instrument	Name of chassis	Communication board	Available slots in the instrument	Other Module (number of slot used by the module)
Single Channel	SP-50	√	1	
	SP-150	√	1 +1 only for LC	LC (1)
	EPP-4000	√	3	4A <sup>a</sup> (2)
	VSP	√	5	LC (1) and/or 4A (2)
	VMP3	√	16	LC (1)
	HCP-803	√	1	80 A <sup>a</sup>
	VMP3-80 <sup>b</sup>			80 A <sup>a</sup>
	HCP-1005	√	1	100 A <sup>a</sup>
Multichannel	VMP3-100 <sup>b</sup>			100 A <sup>a</sup>
	CLB-500	√	1	500 W <sup>a</sup>
	LB-500 <sup>b</sup>			500 W <sup>a</sup>
	CLB-2000	√	1	2 kW <sup>a</sup>
	LB-2000 <sup>b</sup>			2 kW <sup>a</sup>
	External chassis <sup>b</sup>	Booster		4 only for booster boards

a: when provided by default

b: can be connected to any channel board of an VMP3-based instrument, except SP-50, EPP-4000 which are not modular systems.

The numbering of the slot is from the left to right (channel 1 is the closest to the communication board) and downward (Fig. 2).

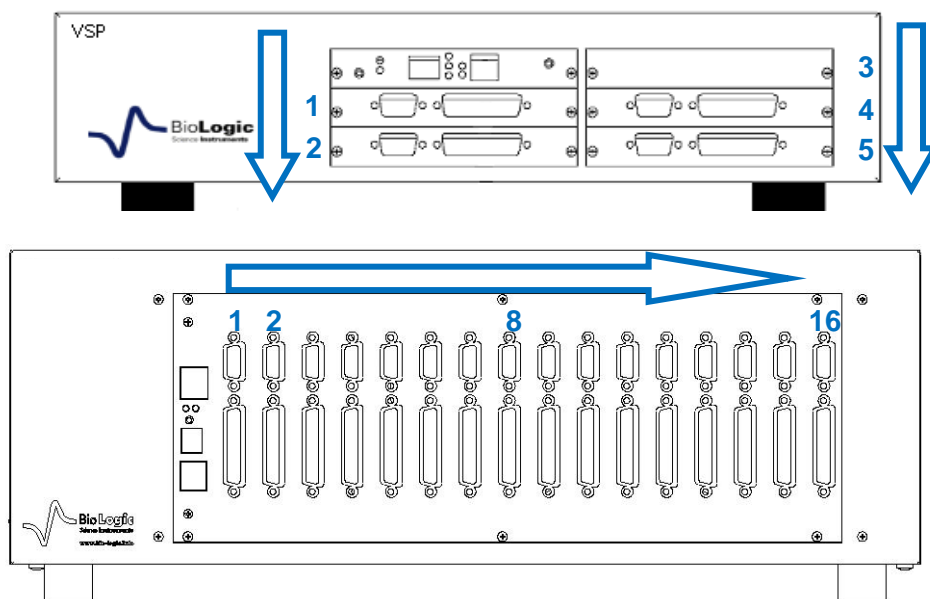

**Fig. 2: Slot numbering.**

Each channel can be set, run, paused or stopped, independently of each other, using identical or different protocols. Any settings of any channel can be modified during a run, without interrupting the experiment.

The channels can be interconnected and run synchronously, for example to perform multi-pitting experiments using a common counter-electrode in a single bath.

Simultaneous measurements of the current and potential of the working electrode are performed continuously, using two 16-bit Analog to Digital Converters. This allows the user to make true power or noise measurements.

Once the protocols have been loaded and started from the PC, the experiments are entirely under the control of the instrument's on-board computer. The instrument temporarily buffers data and regularly transfers it to the PC, which is used for data storage, on-line visualization, on-line and off-line data processing and display.

This architecture ensures a very safe operation since a shutdown of the monitoring PC does not affect the experiments in progress on the instrument.

## 1.2 Software features

Any electrochemical experiment is a set of open circuit sequences and/or galvanic sequences, measuring the potential in both cases, and/or imposed potential sequences, measuring the current.

Usual electrochemical techniques, such as Cyclic Voltammetry, Chronopotentiometry, etc.. are obtained by associations of elementary sequences, and appear as flow-diagrams combining these sequences.

Conditional tests can be performed at various levels of any sequence on the working electrode potential or current, the counter electrode potential, or the external parameters. These conditional tests force the experiment to go to the next step or to loop to a previous sequence, or end the sequence.

The application software package provides useful protocols for general electrochemistry, corrosion, batteries, super-capacitors and custom applications. Standard graphic functions such as re-scaling, zoom, linear and log scales are available. Standard processed files can be created at the user's convenience upon running an experiment for the purpose of real time display of the experiments in progress. Post processing is also possible using built-in

options to create variables at the user's convenience, such as derivative or integral values, etc... Raw data and processed data can be exported as standard ASCII text files.

The user can find more information about EC-Lab<sup>®</sup> software in the software manuals, available in the **“help”** menu of the software.

It is assumed that the user is familiar with Microsoft Windows<sup>®</sup> and knows how to use the mouse and keyboard to access the drop-down menus.



## 2 Software installation on the computer

Before to turn on the instrument, it is recommended to install the software EC-Lab<sup>®</sup> and/or EC-Lab<sup>®</sup> express. For this operation, insert the CD-Rom in the computer. The installation is automatically launched with the “Autorun” function. The first software to be installed is EC-Lab<sup>®</sup>. If your computer does not have a CD-Rom drive, all software can be downloaded from the Bio-Logic website at:

<http://www.bio-logic.info/electrochemistry-ec-lab/downloads/>

### 2.1 EC-Lab<sup>®</sup> software installation



Fig. 3: EC-Lab<sup>®</sup> software installation. Step 1.



Fig. 4: EC-Lab<sup>®</sup> software installation. Step 2.

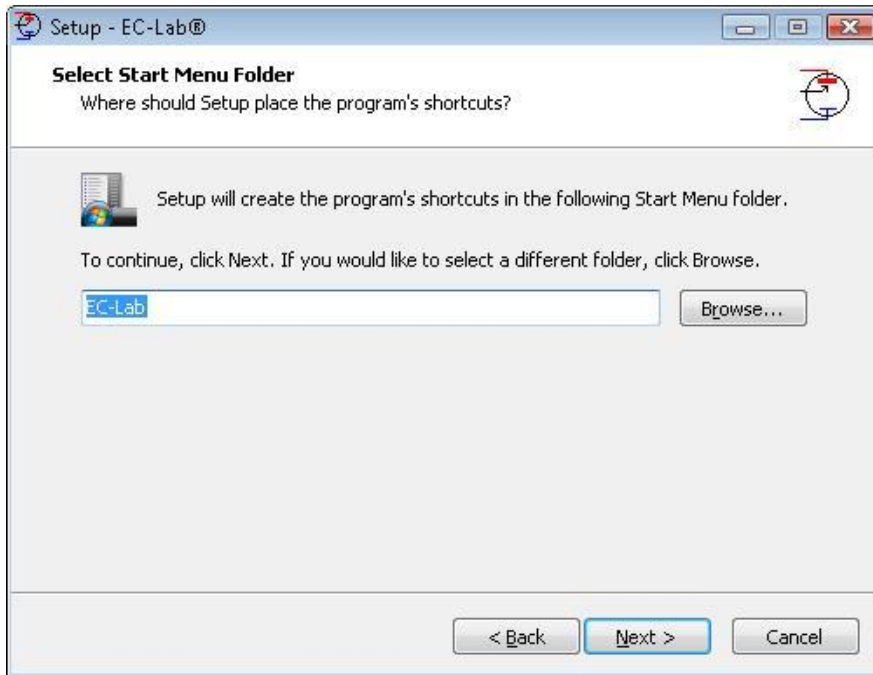

**Fig. 5: EC-Lab® software installation. Step 3.**

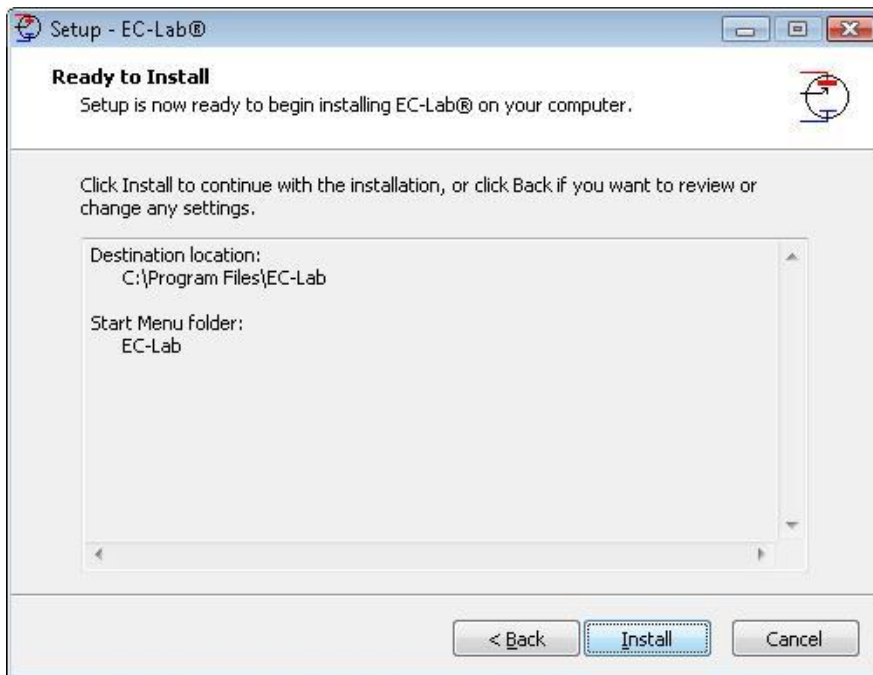

**Fig. 6: EC-Lab® software installation. Step 4.**

During the installation, two main folders are created.

- “**EC-Lab.exe**”, the **USB drivers**, **TeraTermPro** and other files are located in the in the “**Program Files**” directory (Fig. 7 top).
- “**Batch**”, “**Data**” (include the data samples), “**Documents**” (include manuals and getting started document), “**Newsletter**”, “**Settings**” (includes the default settings files), “**Temp**” folders and also the “**EC-Lab.ini**” & “**VMPerr.txt**” files (includes the initial settings) are installed in the “Documents” directory (Fig. 7 bottom).

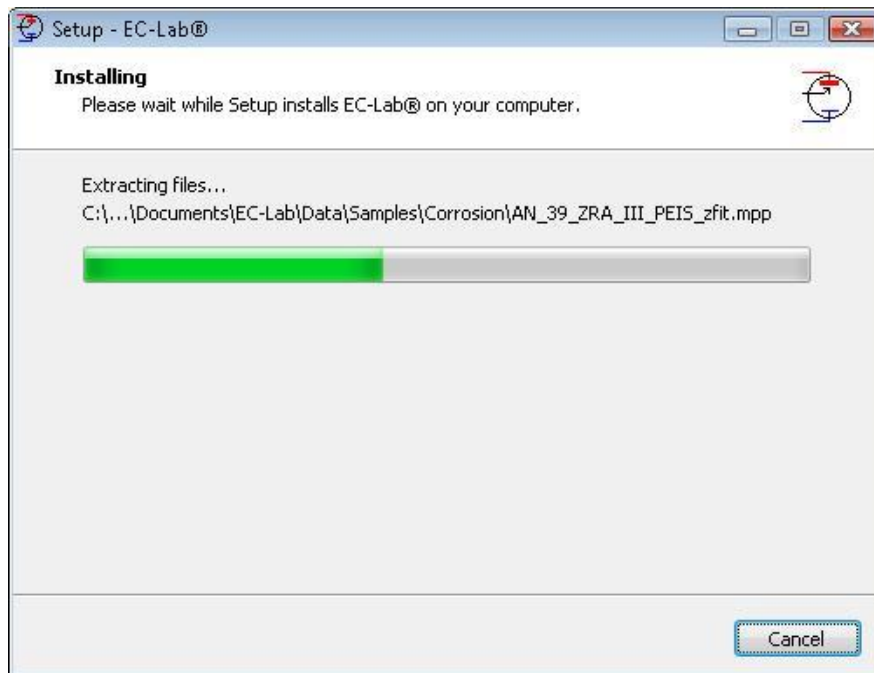
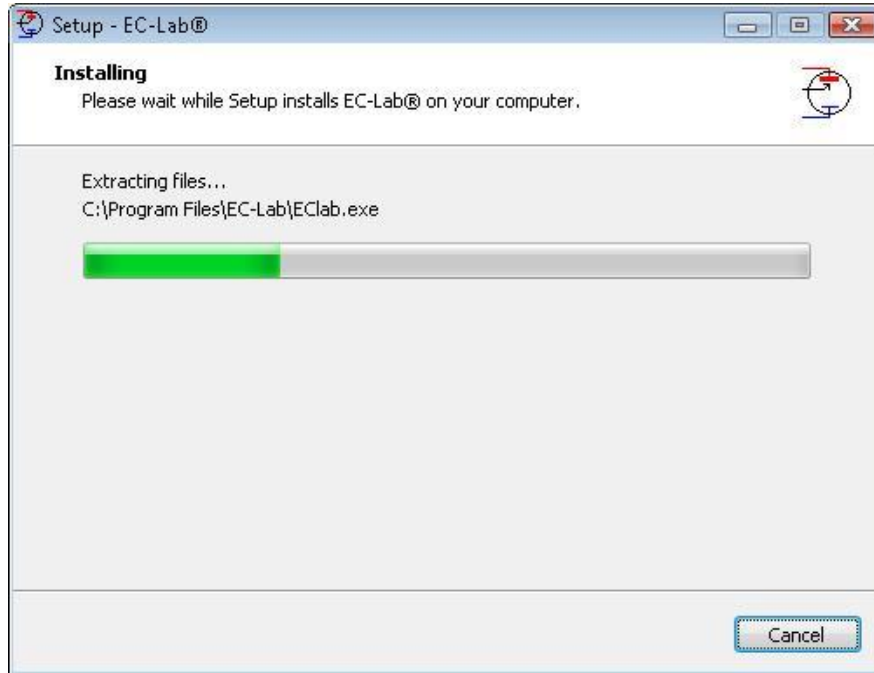

**Fig. 7: EC-Lab® software installation. Step 5. (Top): Installation in the “Program Files” Directory. (bottom): Installation in the “Documents” Directory.**

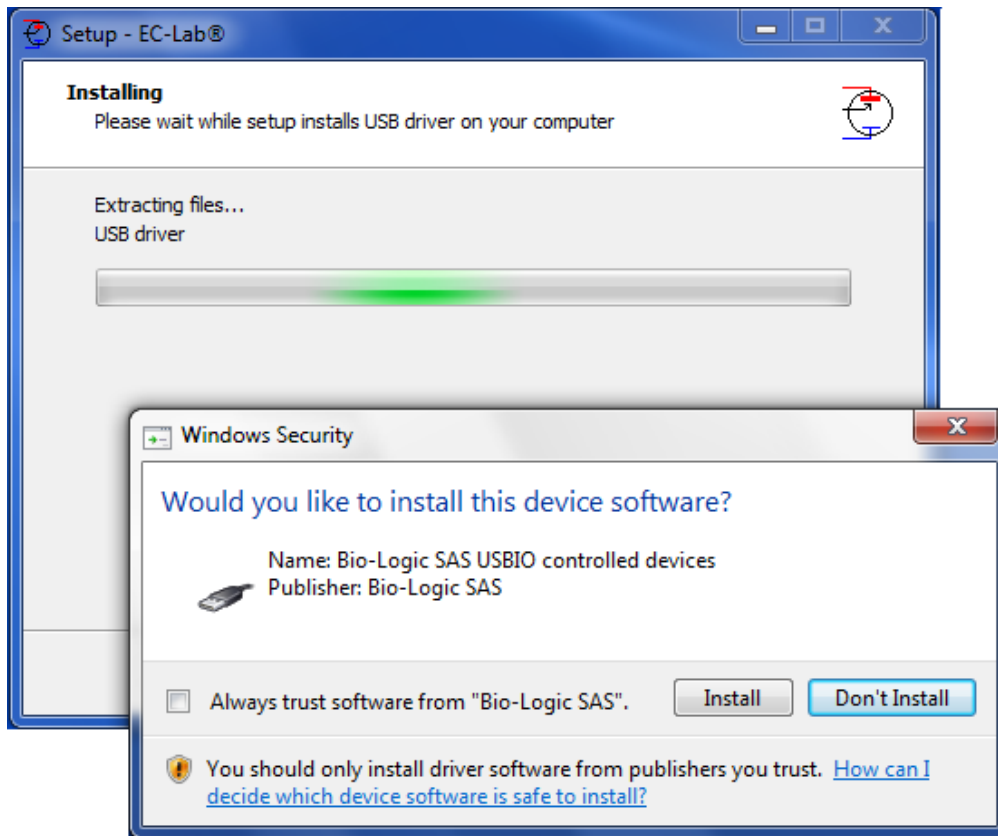

Fig. 8: EC-Lab® software installation. Step 6.

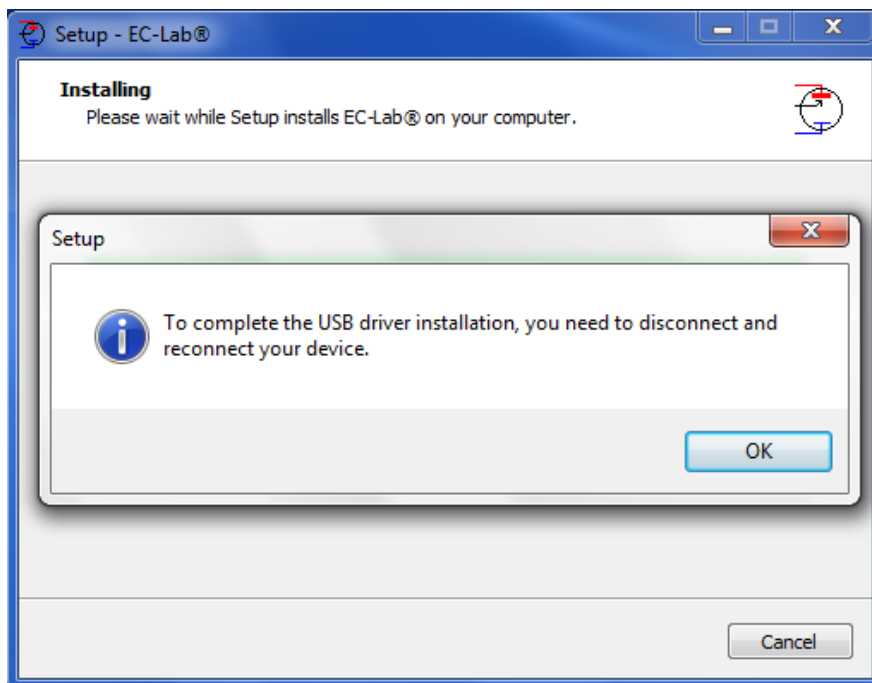
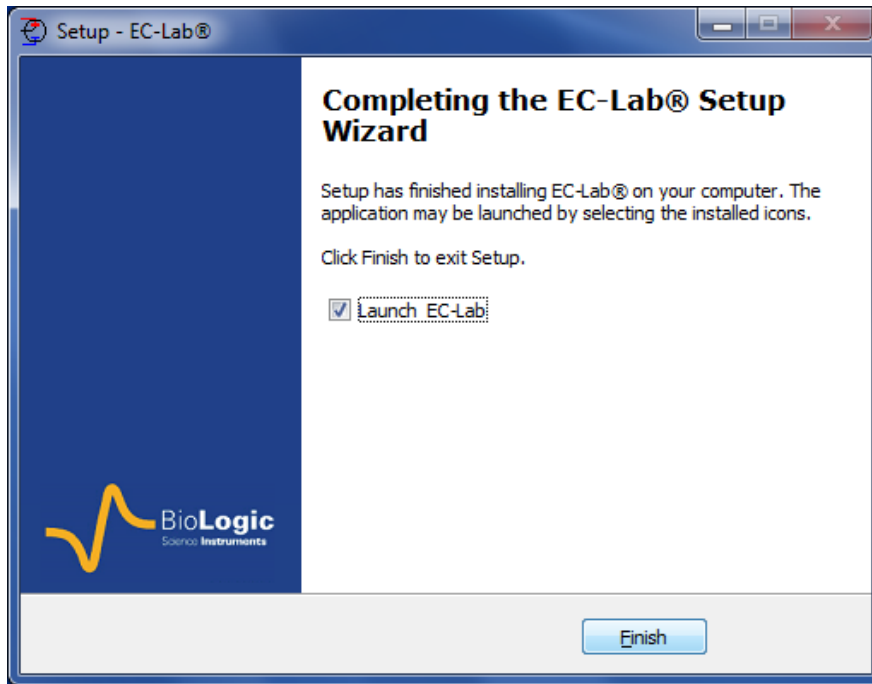

Fig. 9: EC-Lab® software installation. Step 7.



**Fig. 10: EC-Lab® software installation. Step 8.**

At the end of the installation, the instrument connected by USB is detected and ready to get used.

## 2.2 EC-Lab® Express software/OEM package installation

The installation of EC-lab® Express software and the OEM package is exactly done in the same way as for EC-Lab®. Please see the above section for the installation.

## 2.3 Errors during the installation

During the installation an error may occur if you are not administrator of the computer.

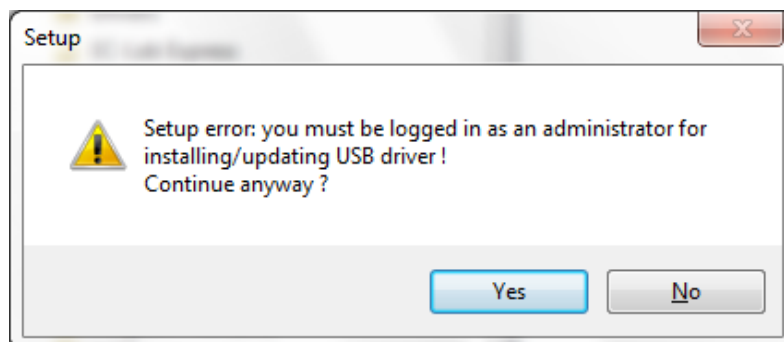

**Fig. 11: Error during the installation.**

In this case it is necessary to contact your network administrator for the installation.



### 3 PC installation and configuration

---

IT IS HIGHLY RECOMMENDED TO ASK FOR ASSISTANCE FROM YOUR NETWORK ADMINISTRATOR.

**NOTE:**

IP ADDRESSES OF THE INSTRUMENT(S) AND THE COMPUTER(S) HAVE TO BE THE SAME DURING THE EXPERIMENT. SO THE AUTOMATIC WINDOWS UPDATE HAS TO BEEN DISABLED IN ORDER TO AVOID ANY IP ADDRESS CHANGE DURING EXPERIMENT.

#### 3.1 TCP/IP installation and configuration

The instrument uses the TCP/IP (Transfer Control Protocol / Internet Protocol) to exchange data with the PC. This protocol uses IP addresses to identify hosts on a network, so you will need 2 IP numbers, one for the instrument and one for the PC. For a direct connection between the instrument and the PC, you can use the following numbers (default factory settings):

<b>192.109.209.127 or 192.168.0.2</b>	(PC)
<b>192.109.209.128 or 192.168.0.1</b>	(INSTRUMENT)

If you connect the PC and the instrument to your local network, you need to ask your system administrator for 2 VALID IP NUMBERS FOR YOUR INTRANET (and the sub-net mask and the gateway numbers if necessary).

Note:

- 1- Before the installation of the TCP/IP protocol, your Ethernet board must be properly installed on your computer.
- 2- With Windows<sup>®</sup> Vista, it is recommended to replace the default IP addresses with other ones even if the instrument is directly connected to the computer. Windows Vista does not accept universal IP addresses. You can use the following ones **192.109.209.127** for the PC and **192.109.209.128** for the instrument.

The TCP/IP protocol must be installed on the PC computer to establish the connection with the instrument.

If your computer is connected to a network, the TCP/IP protocol may be already installed. In that case the computer already has an IP address (obtained automatically). When the computer is connected directly to the instrument, it is necessary to give a static IP address to the computer. The following part describes how to give a static IP address to the computer:

- 1- In the **Control Panel**, double click on the **Network Connections** icon. Then the **Local Area Connection window** appears. Right click on the name and choose "**Status**" to see the computer IP address in the network. The window below is displayed:

2- On the “**General**” tab click on **Properties**. This will load the following window:

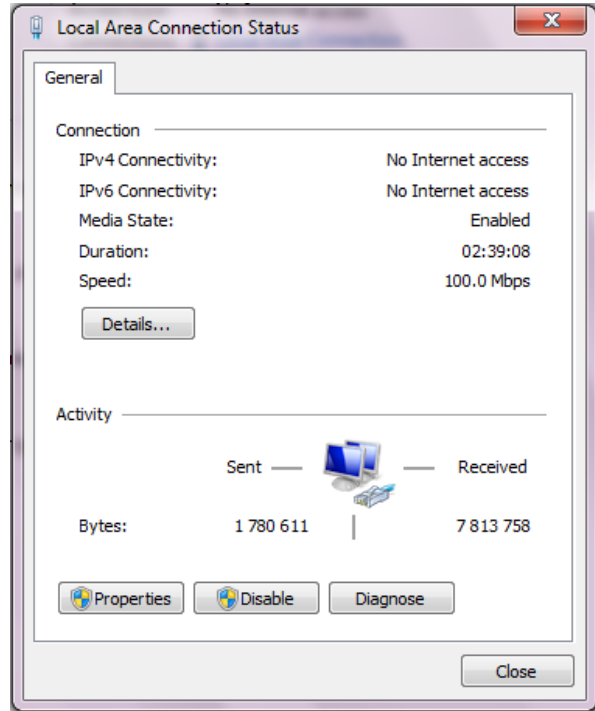

**Fig. 12: Local Area connection status.**

3- Select **Internet Protocol (TCP/IPv4 or TCP/IPv6)** and click on the **Properties** button. The window on the left appears.

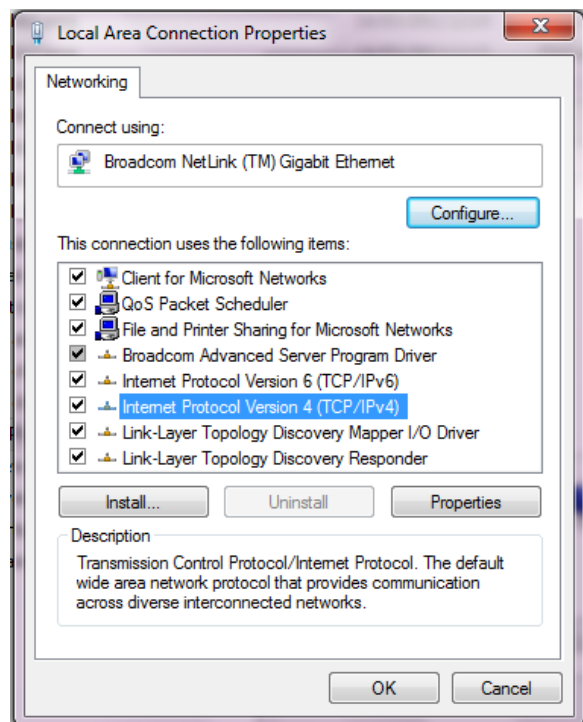

**Fig. 13: Network window.**



4- At this point of the installation, the user has to activate the “**Use the following IP address**” box.

WARNING: THERE MIGHT BE ANOTHER TCP/IP PROTOCOL INSTALLED CALLED "TCP/IP DISTANT ACCESS", DO NOT CLICK ON THIS LINE!

5- Enter the PC **IP address**, DO NOT ENTER A NETWORK MASK (it will automatically be added) and click on the OK button.

WARNING: IP ADDRESSES MUST BE UNIQUE IN A NETWORK

6- Restart the PC. Now the PC and the INSTRUMENT are in the same network.

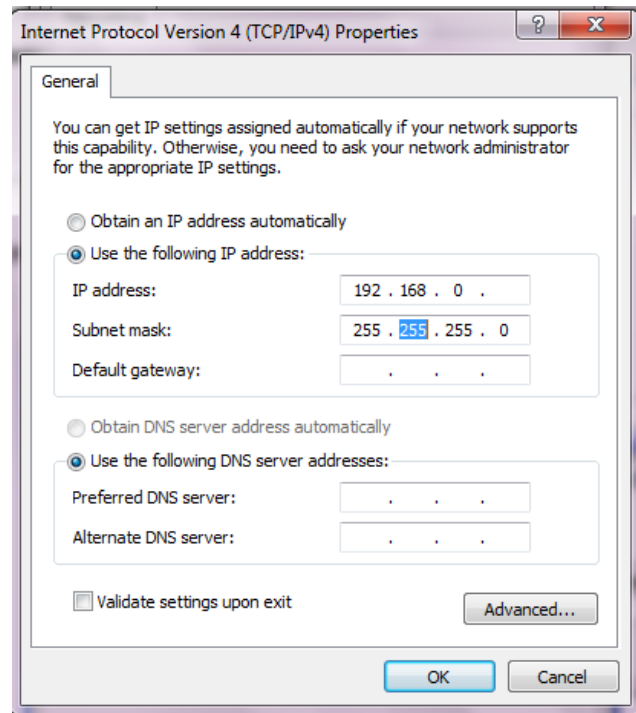

Fig. 14: TCP/IP properties window.

## 3.2 USB driver installation

The instrument can use an USB connection to exchange data with the PC. This connection requires USB drivers to be installed in the computer operating system. Installation of the drivers will vary depending upon the operation system of the computer.

We highly recommend that the user works with **at least** Windows® 2000 to control the potentiostat through an USB connection.

For other Windows® versions, the user will probably have to specify where to find the driver on the CD-Rom. In this window select the automatic installation of the software.

### 3.2.1 Windows XP installation

The way to proceed to install USB drivers is described below for Windows® XP Pro. After connecting the instrument to the computer with the USB cable power on the instrument. When the user powers on the instrument, Windows automatically detects a new USB device. Then the following installation window appears:



Fig. 15: USB device installation window. Step 1.

In this window, select “**No, not this time**” and click on “**Next**”. The following window is displayed:

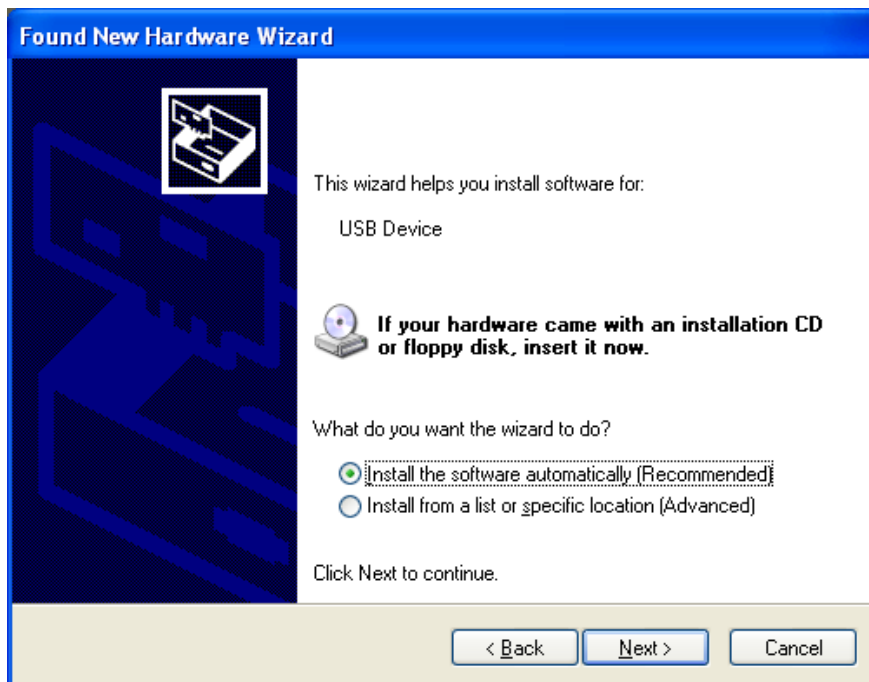
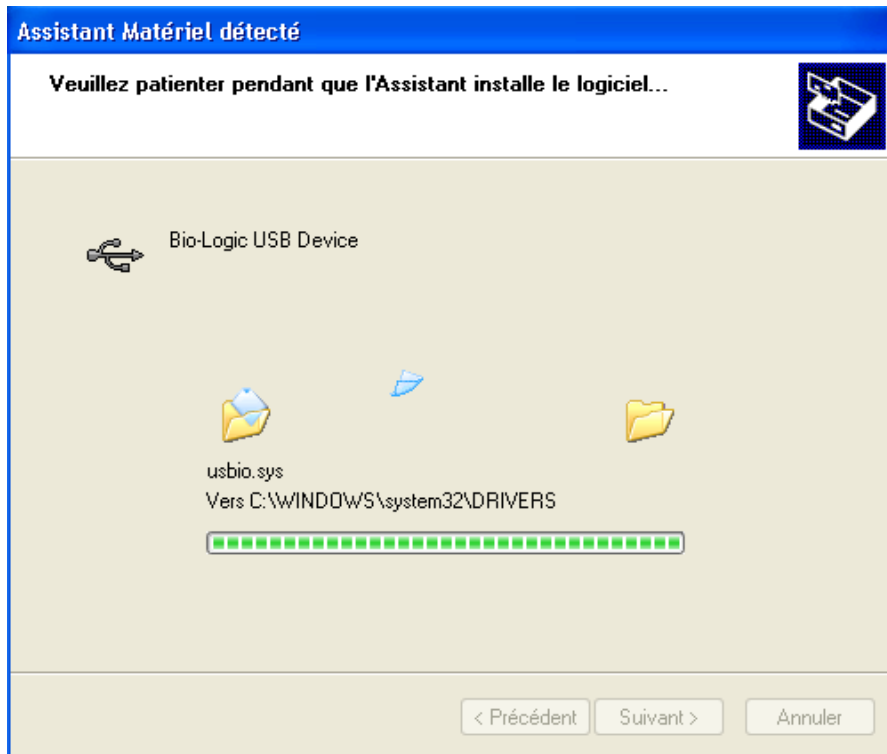
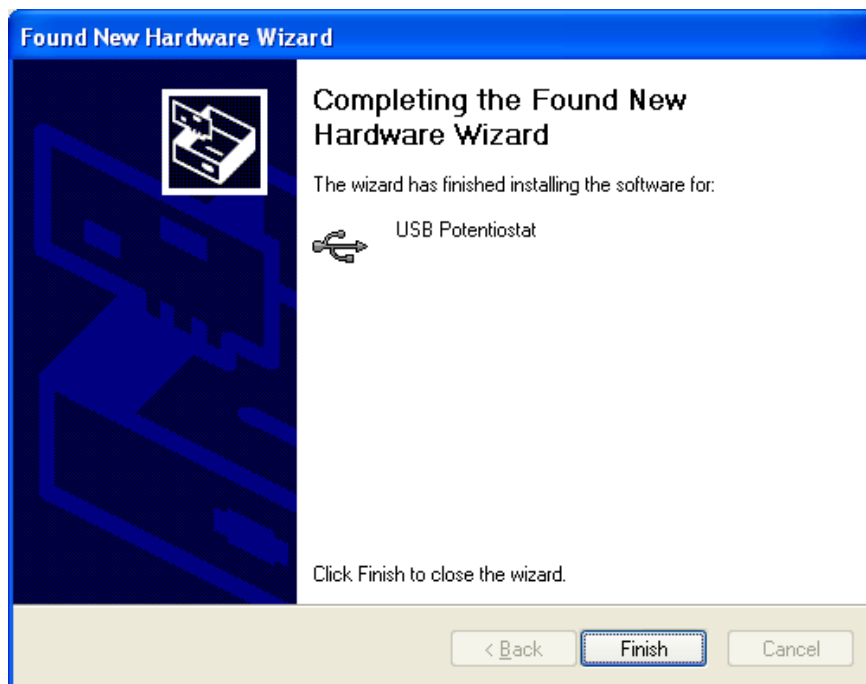

Fig. 16: USB device installation window. Step 2.

Check that the EC-Lab<sup>®</sup> installation CD is in the CD drive. If it is, Windows<sup>®</sup> XP will automatically search on the CD, find the USB driver and complete the installation.



**Fig. 17: USB device installation window. Step 3.**

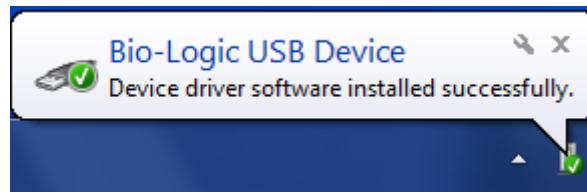

**Fig. 18: USB device installation window. Step 4.**

Click on Finish. The potentiostat can now be connected to the computer through an USB connection. It is not necessary to restart the computer after this installation.

### 3.2.2 Windows Seven, Eight and Vista installation

With Windows Seven, Eight and Vista systems, the USB driver is automatically installed when the instrument is detected. And the following message is displayed at the end of the installation:



**Fig. 19: USB device installation for Seven and Vista.**

### 3.2.3 Uninstall USB drivers

For this operation, please open the folder: C:\Program Files\Bio-Logic\USBIO as described in the picture below. Double click on “uninstall” to proceed.

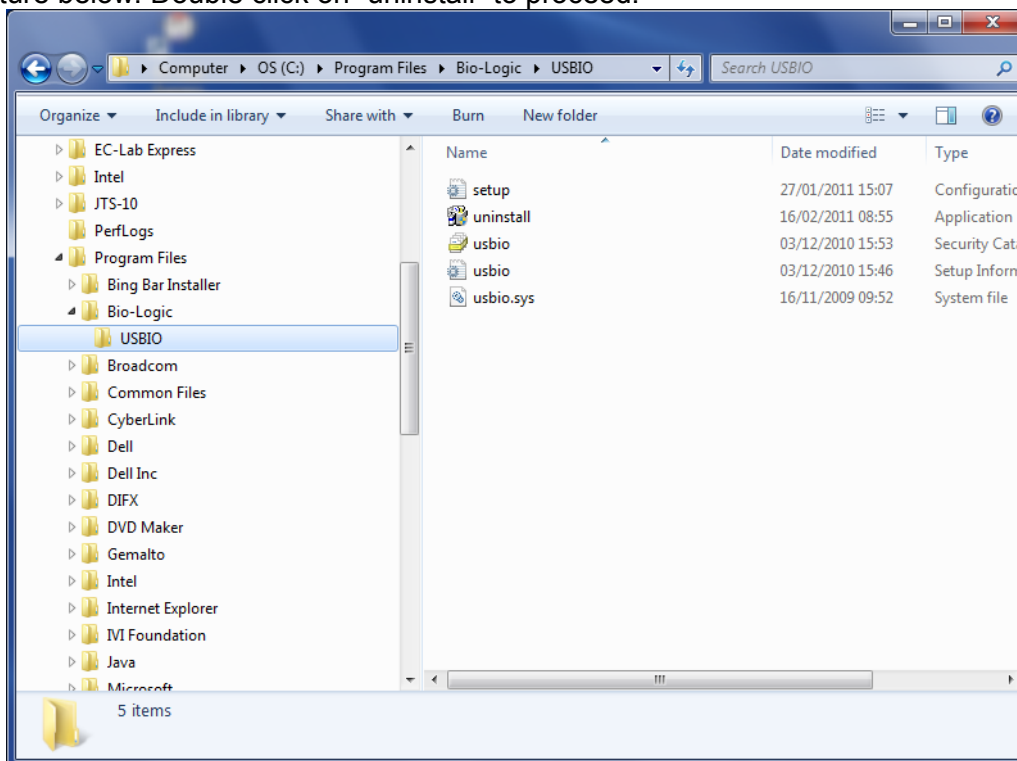

**Fig. 20: Uninstall USB driver. Step 1.**

The uninstall wizard is launched. Click on the “Uninstall” button to proceed.

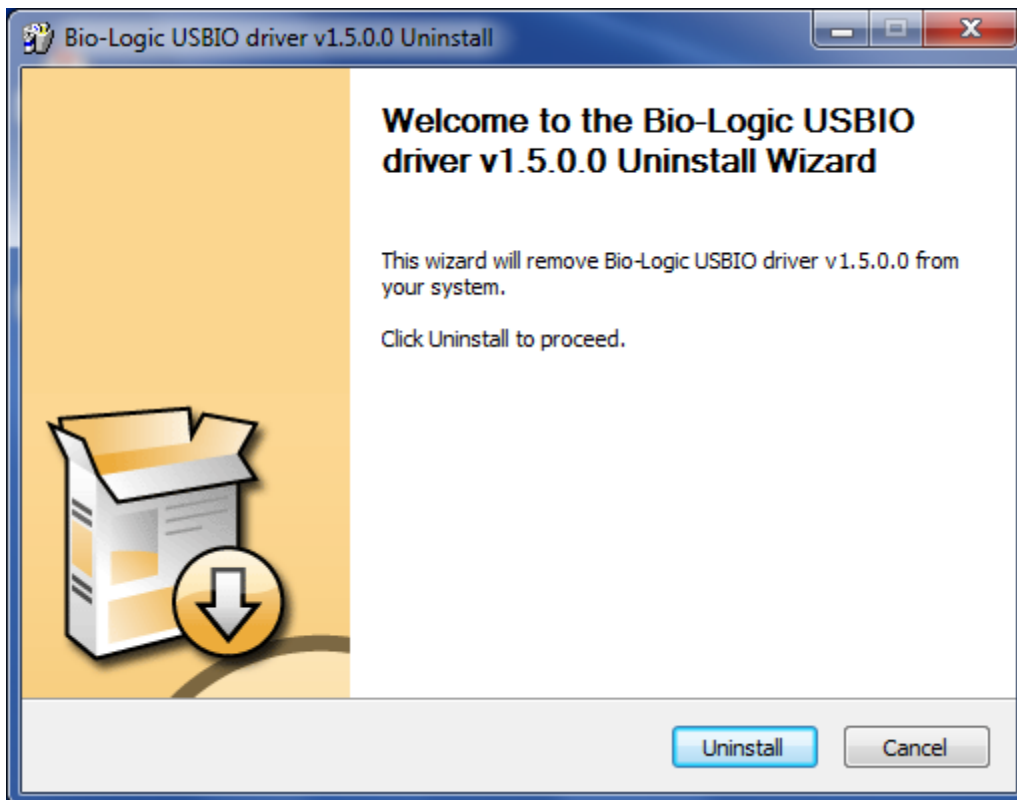

Fig. 21: Uninstall USB driver. Step 2.

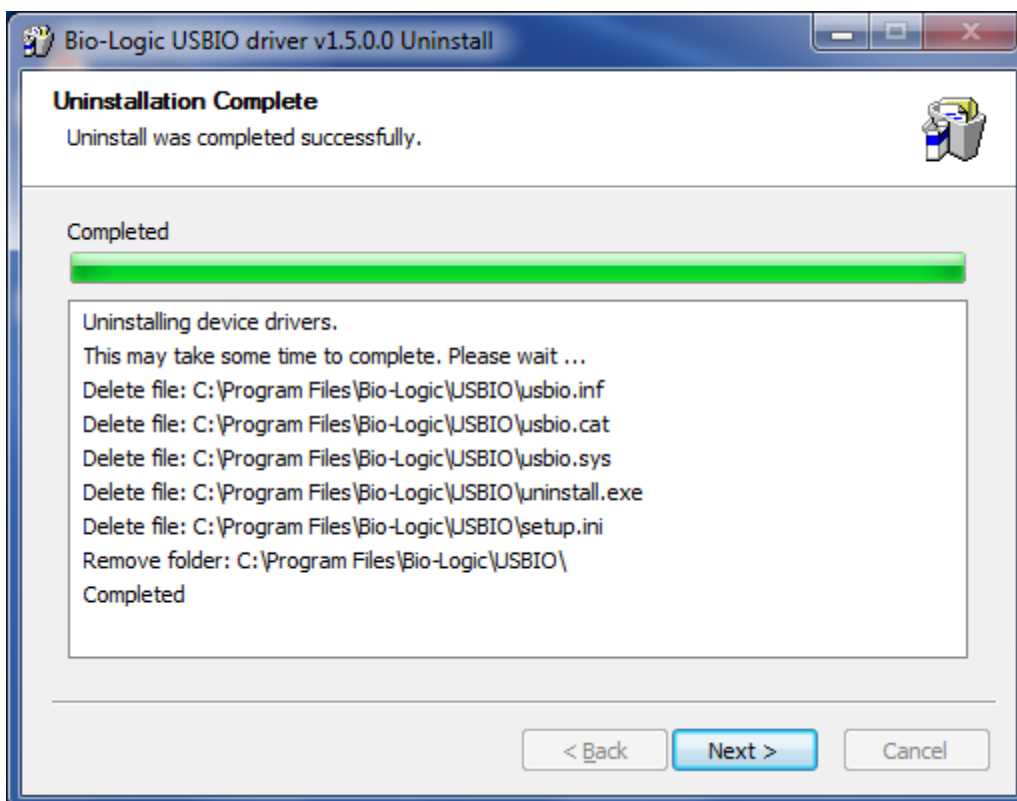
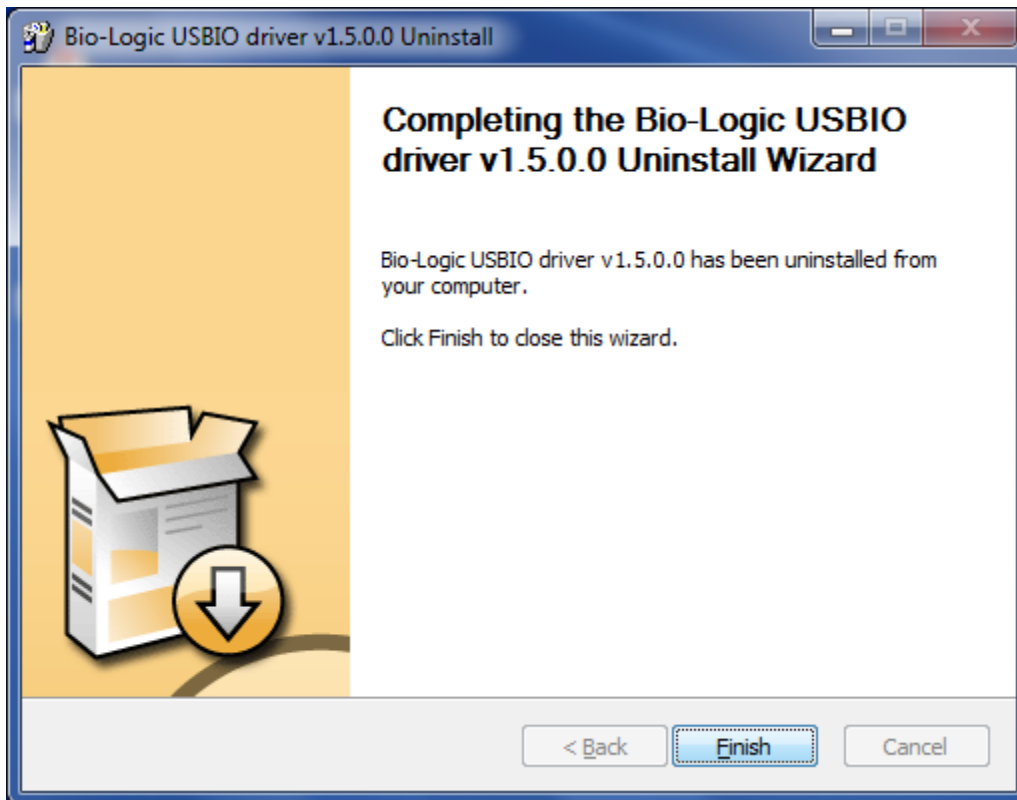

Fig. 22: Uninstall USB driver. Step 3.



**Fig. 23: Uninstall USB driver. Step 4.**

When you click on the “Finish” button the USB driver is completely uninstalled.

## 4 Instrument installation

### 4.1 Connections

**NOTE:**

When multichannels instruments (VSP or VMP3) are used or when measurements require fast sampling rate, Ethernet connection is highly recommended.

Depending on your local installation, you can use a direct connection (one PC to one instrument) or a network connection (one or several PCs to one or several instruments).  
By default; the IP address of the instrument is 192.109.209.128 or 192.168.0.1.

#### 4.1.1 Direct USB connection

This connection can be done easily using the USB connection cable. One end must be connected to the instrument communication board and the other one to the control unit of the computer.

#### 4.1.2 Direct Ethernet connection

Connect directly the computer to the instrument with the Ethernet cable. The IP addresses of both devices have to be in the same network. It means that the number of the three first groups of the IP address has to be the same, For example, 192.109.209.128 or 192.168.0.1 for the instrument and 192.109.209.127 or 192.168.0.2 for the computer, respectively.

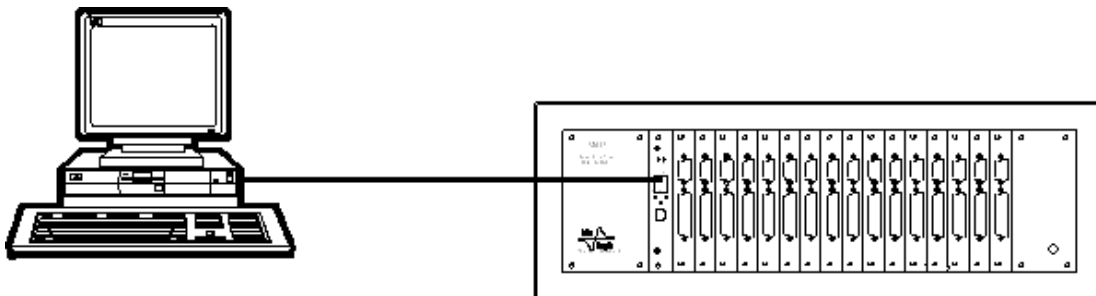
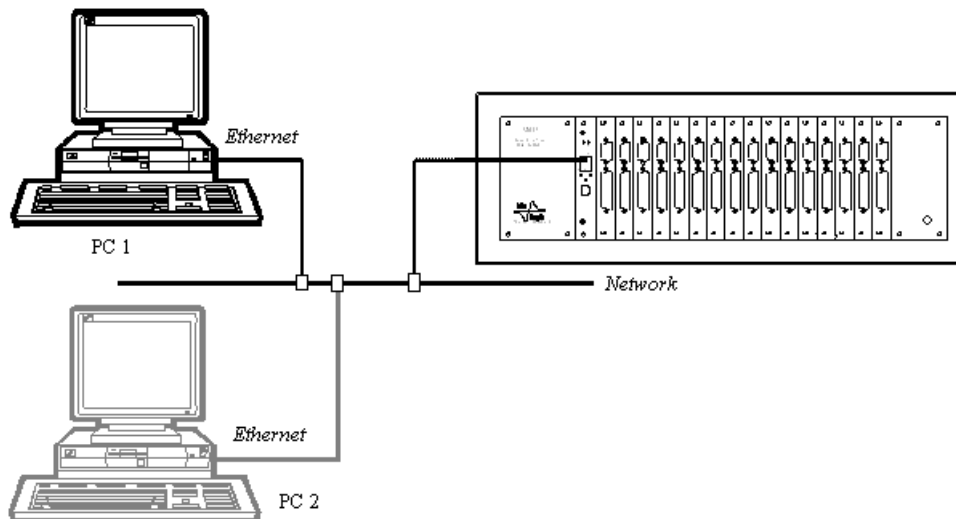

**Fig. 24: Direct connection: one instrument to one PC.**

#### 4.1.3 Network connections

Several PCs can be connected to the same instrument through the network.

**WARNING:** check IP addresses before connection to avoid any IP conflicts (see TCP/IP configuration chapter).



**Fig. 25: Network connection: one instrument to several PCs.**

Alternatively, a single PC can control several instruments through the network.

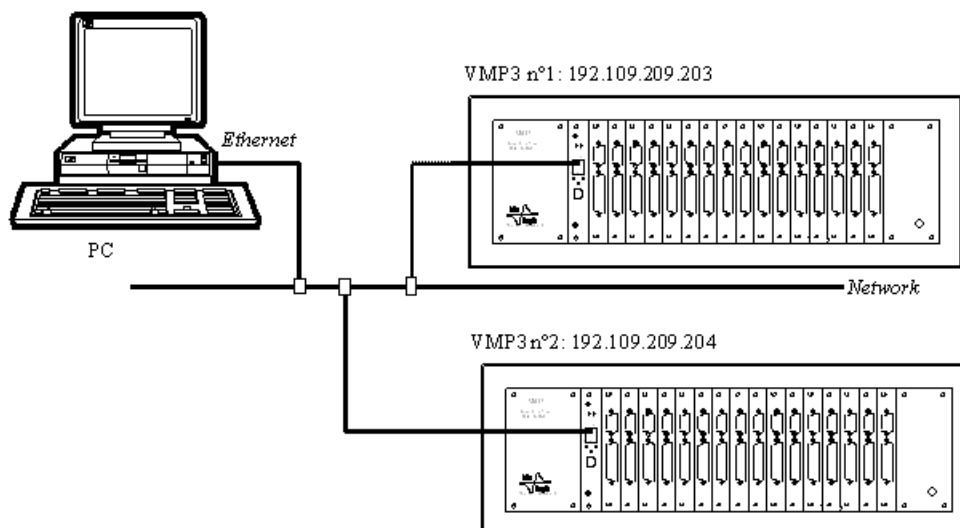

**Fig. 26: Network connection: one PC to several instruments.**

## 4.2 Power supply

Power supply connections are on the rear panel of the instrument and current booster units.



## 5 PC connection to the instrument

### 5.1 Network parameter configuration with the Ethernet connection

The Ethernet connection on the communication board is a 10/100 baseT compatible with every network. The **USB** connection is also integrated on this board. When it is installed in a Local Area Network (via the Ethernet connection), the instrument is automatically detected by the computers of the network. It becomes very easy to select an instrument in the network and modify its IP address via the Ethernet connection. This is possible with a MAC Address (set at the factory on the communication board) even if the instrument is not in the same network as the computer (before being connected together). Now new instruments are delivered with the following IP address commonly used as default: **192.109.209.128 or 192.168.0.1**. You can either manage your instrument directly with the or change the instrument's IP address to add the instrument in your local network. The way to proceed is the same in both cases. The first step is the detection of the new instrument by a computer (directly or via the network). The second step is the IP address change before the connection, either to have both the instrument and the computer in the same LAN or to make a small network including the instrument and the PC.

Note: - to switch between EC-Lab<sup>®</sup> and EC-Lab<sup>®</sup> Express software, the instrument has to be switched off and restarted.

- HCP-1005 and CLB-2000 are not supported by EC-Lab<sup>®</sup> Express, only EC-Lab<sup>®</sup> is able to control these units.

### 5.2 Connection to the computer with EC-Lab<sup>®</sup> software

The procedure to connect your computer directly or via the network to the instrument is as follows. Use the Ethernet cable or USB cable for a direct connection and a cable for the network connection.

- 1) Launch EC-Lab<sup>®</sup> software V10.20 or higher.

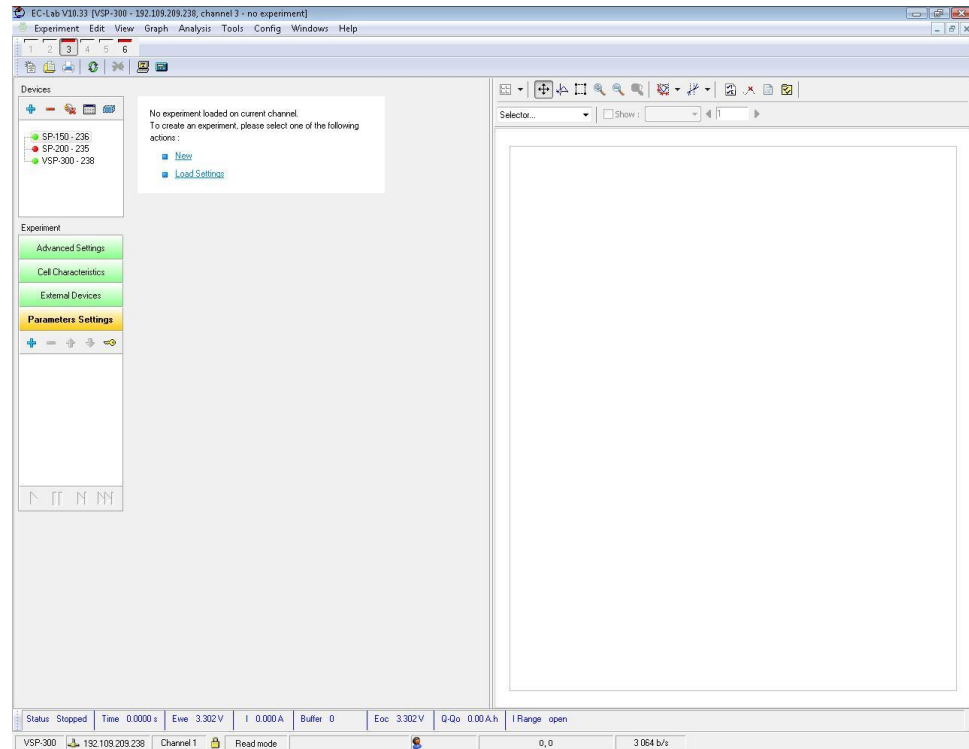
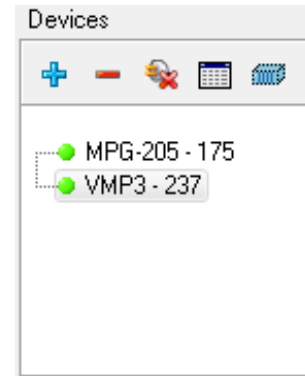

Fig. 27: Main window of EC-Lab<sup>®</sup>.

- 2) In the “**Devices**” frame, click on the “**+**” button to add the instrument of interest in the list.  
Only one session of EC-Lab<sup>®</sup> is needed to control several instruments.



**Fig. 28: “Devices” frame for connection.**

Note: This step is required only for the first time. The instruments configured previously are saved and will be displayed in the list of device each time EC-Lab<sup>®</sup> is opened. In that case, go directly to step 6.

- 3) The window shown in the Fig. below appears. Click on “**Refresh**” to see the instruments present on your network.

Note: The automatic search frame shows the name of the instruments detected with their serial numbers (#). A MAC address is given to each instrument at the factory. The MAC address is used to detect the instrument in a LAN even if its IP Address is not valid in the network. It is also used for the detection of instruments connected by USB.

Automatic detection will give a list of instruments detected (except VMP1 and firsts VMP2).

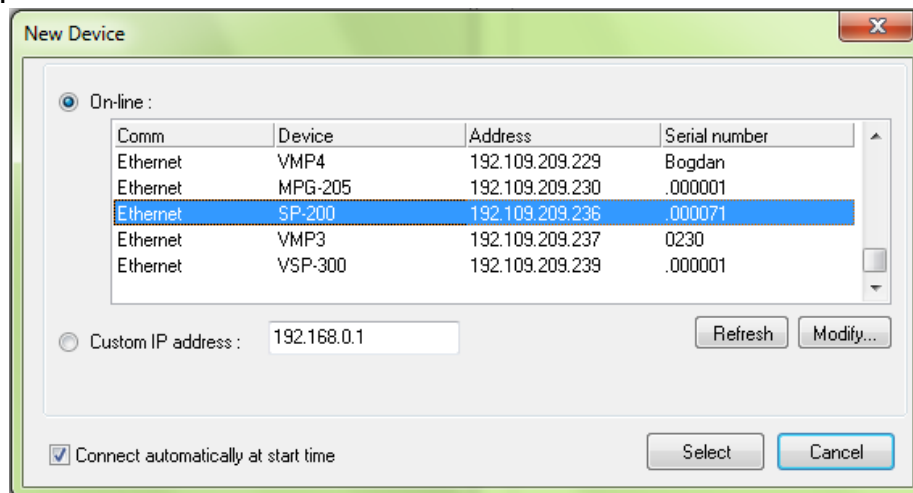

**Fig. 29: “New Device” window to select and add an instrument to the current devices.**

- 4) Select the instrument and click on the “**Select**” button.  
Note: If the IP address of the instrument is not valid, it has to be changed (see next paragraph).

- 5) The instrument selected appears in the list displayed in the “**Device**” frame. Then, the connection is established automatically.

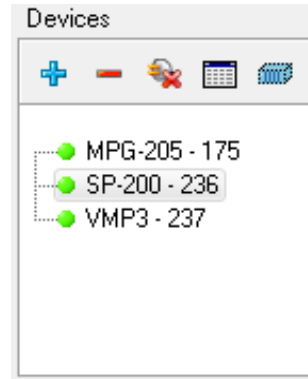

**Fig. 30: “Devices” frame for connection with the new device.**

- 6) Note if the instrument is already in the list, the user has to select the instrument in the “**Device**” frame and then click on the “**connect**” button .

It is possible to remove a device by clicking on the “-“ button.

When the connection is established “**Connected**” is displayed in the connection status of the “**Connection**” window. One can see the “**Connection status**” with the device type and the instrument’s IP Address.

### 5.2.1 Modification of the instrument IP address

If the IP address of the instrument is not valid i.e. two same IP addresses or not in the appropriate network, IP address has to be changed.

On the “**New device**” window select the desired instrument and click on “**Modify**”. The following window then appears:



**Fig. 31: “Advanced Ethernet settings” of the “New Device” window used to change the instrument IP Address.**

Modify the IP Address to have a valid address in your network. Repeat this procedure with the Gateway and click on “**Modify device**”. A “**configuration changed**” message is displayed in green when the instrument receives the new IP address. Several “**Bip**” sounds are emitted indicating that the communication board is reinitialized with the new IP Address. “**Configuration changed**” appears at the bottom of this window.

Then click “OK” to display the “New Device” window where you have to click “Refresh” to refresh the window and select your instrument IP address.

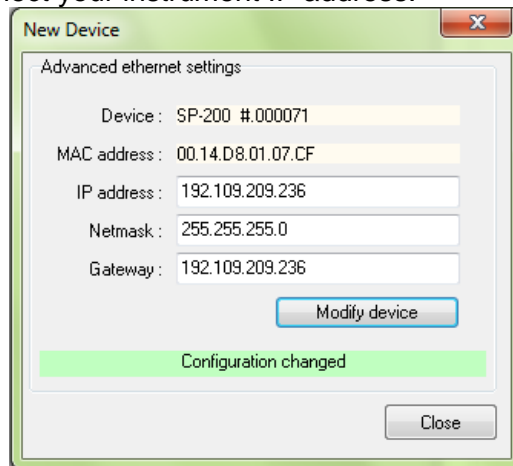

Fig. 32: New configuration.

Now the instrument is ready for use.

Note that it is possible to communicate with the instrument from another subnet with the following ports 23455 (broadcast), 23456, 23457 and 23458.

### 5.3 Connection using EC-Lab<sup>®</sup> Express software

- 1) Launch EC-Lab<sup>®</sup> Express software.

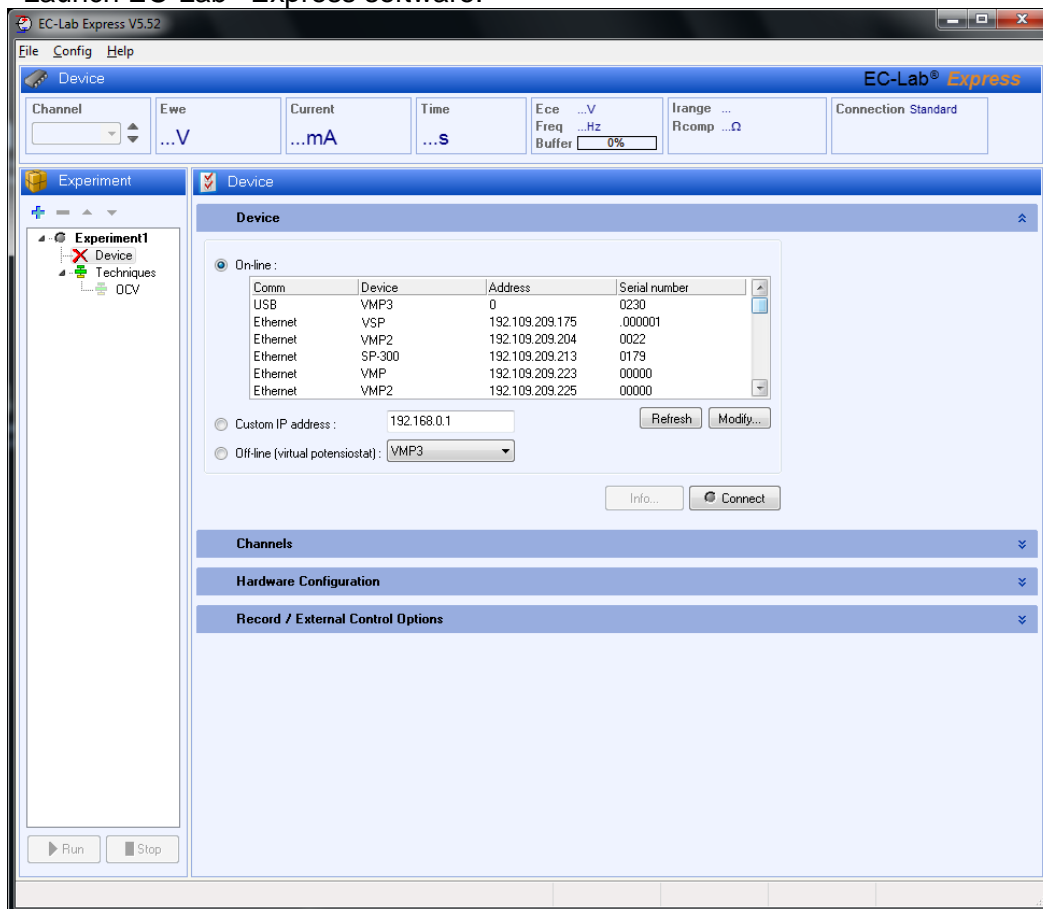

Fig. 33: Main window of EC-Lab<sup>®</sup> Express.

- 2) In the “device” frame, all the instruments available (connected by USB, direct Ethernet or through a LAN) are displayed.

The window shown in Fig. below appears. Click on “**Refresh**” to see the instruments present on your network.

Note: The automatic search frame shows the name of the instruments detected with their serial numbers (#). A MAC address is given to each instrument at the factory. The MAC address is used to detect the instrument in a LAN even if its IP Address is not valid in the network. It is also used for the detection of instruments connected by USB.

Automatic detection will give a list of instruments detected (except VMP1 and firsts VMP2).

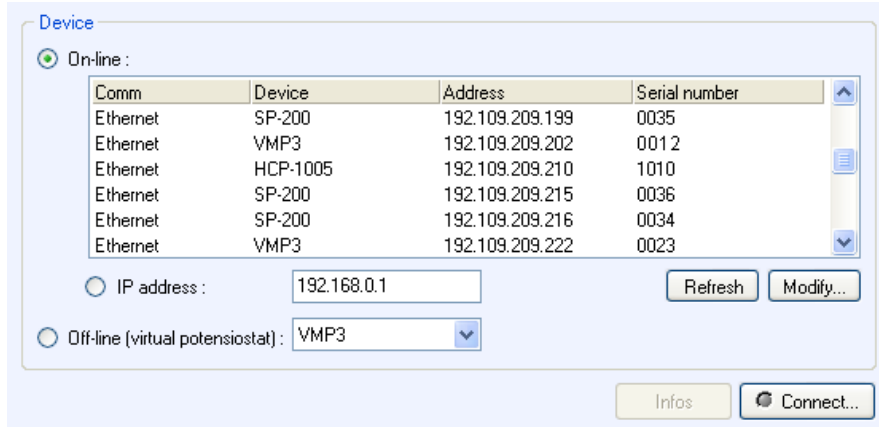

**Fig. 34: Device connection window.**

- 3) Select the instrument of interest and click on the “**Select**” button.

Note: If the IP address of the instrument is not valid, it has to be changed (see next paragraph).

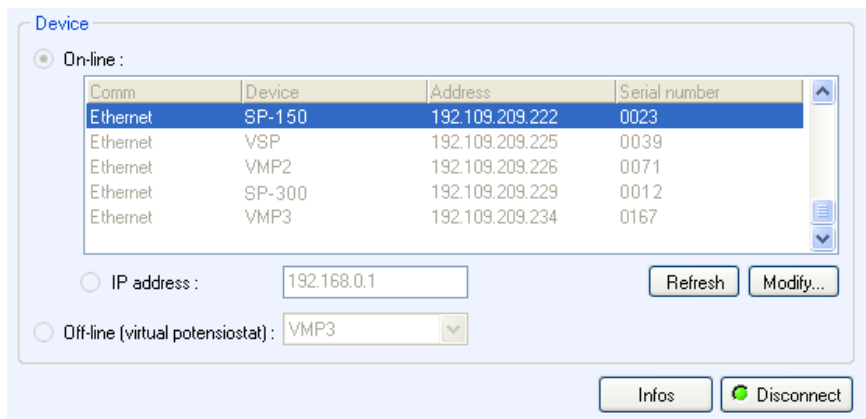
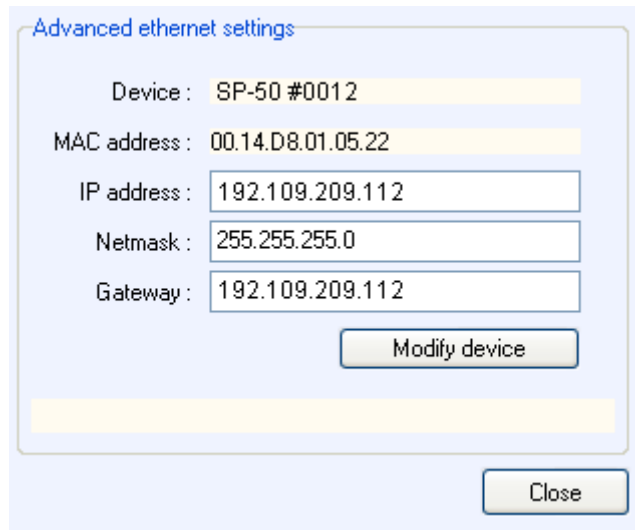

**Fig. 35: Device connection window (selected instrument).**

- 4) Click on “**Connect**”. The connection button turns into a Disconnect button and becomes green to show the effective connection.

### 5.3.1 IP address modification of the instrument

If the Ethernet connection requires changing the instrument's IP address, select the instrument and click on "**Modify**". The following window appears:



**Fig. 36: "Advanced Ethernet settings" of the "New Device" window used to change the instrument IP Address.**

Modify the IP Address to have a valid address in your network. Repeat this procedure with the Gateway and click on "Modify device". Then the new IP Address is sent to the instrument and a "configuration changed" message appears in green. Several "Bip" sounds are emitted by the instrument indicating that the communication board is reinitialized with the new IP Address. "Configuration changed" appears at the bottom of this window.

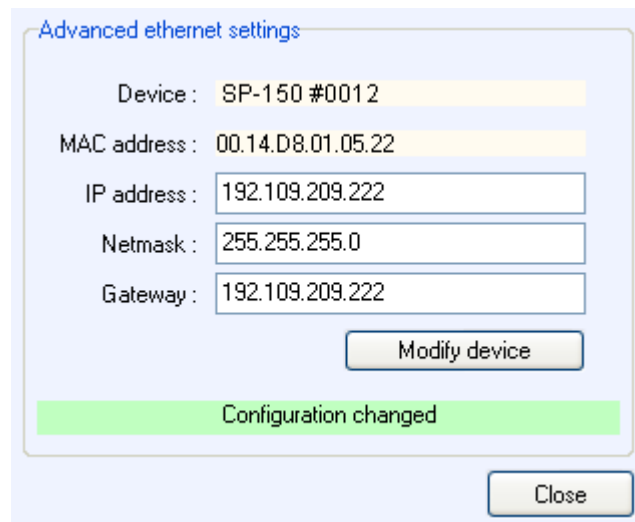

**Fig. 37: New configuration.**

Then click "**OK**" to display the "New Device" window and "**Refresh**" to refresh the window and select your instrument's IP address. Click on the "Select" button. Now the instrument is connected and ready for use.

## 5.4 Windows Security Alert

When the user tries to find an instrument in the network or by USB, the software will use a broadcast that may be stopped by windows firewall. In this case click on the “Allow access” button:

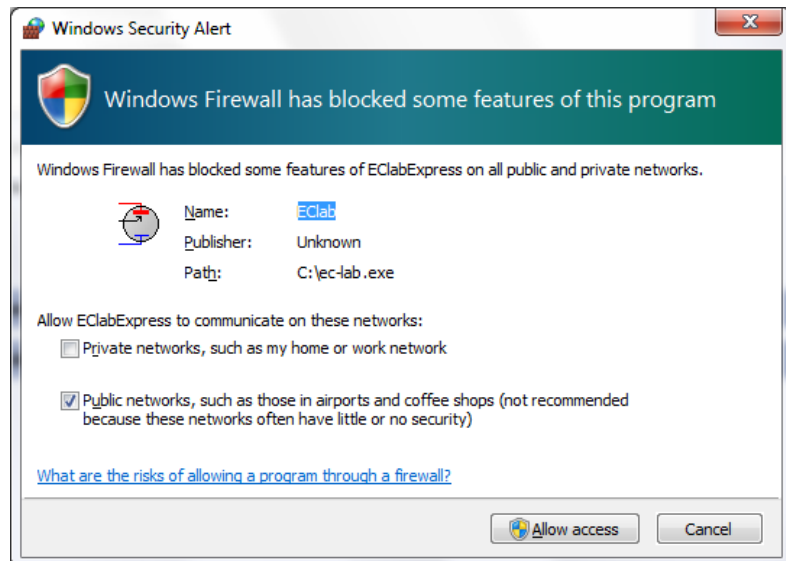

Fig. 38: “Windows security Alert” window.

## 5.5 Firmware Upgrade with EC-Lab<sup>®</sup> software

When the user receives a new unit from the factory, the software (in the computer) and firmware (in the instrument) are installed and upgraded. The instrument is ready for use. It does not need to be upgraded. However, when new EC-Lab<sup>®</sup> version is released (with new protocols or improvements) firmware has to be updated and installed by the user.

## 5.6 Firmware Downgrade with EC-Lab<sup>®</sup> software

It is possible to downgrade the firmware of the instrument in an advanced tool available in EC-Lab<sup>®</sup>. This procedure should be done by an advanced user and should be only done exceptionally.

### WARNING:

- If the user downgrades the firmware of the instrument, he has to use the corresponding EC-Lab<sup>®</sup> version. For example, if the firmware of the instrument is the V10.20, user has to control the instrument with EC-Lab<sup>®</sup> V10.20.
- Make sure that the older version supports the instrument.

Instruments	Lowest compatible version
SP-50	V10.00
SP-150	V9.56
EPP-4000	V9.56
VSP/VMP3	V9.56
HCP-803/ VMP3-80	V9.56
HCP-1005/VMP3-100	V9.94
CLB-500/LB-500	V9.56
CLB-2000/ LB-2000	V10.11
External Booster chassis	V9.56

The procedure to follow is described hereafter:

**NOTE:**

- The example shows a downgrade from V10.23 to V10.12 but the procedure will be the same for other versions.

- 1) Make sure that both versions are installed on the computer (here it is **V10.12** and **V10.23**).

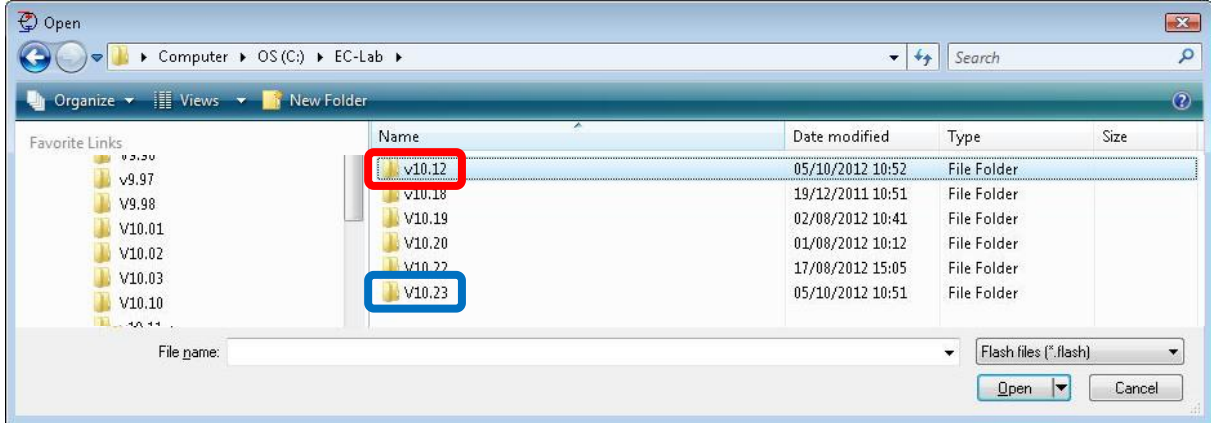

**Fig. 39: Both versions on the computer.**

- 2) Connect the instrument with the latest software version (here: **V10.23**)\*

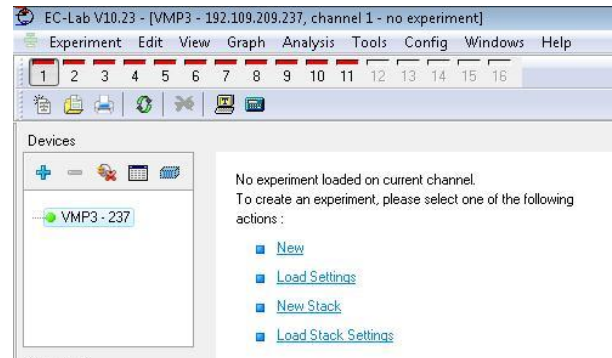

**Fig. 40: connection under the latest version.**

- 3) Open “Firmware Upgrade/Downgrade” tool in the “Tools” menu

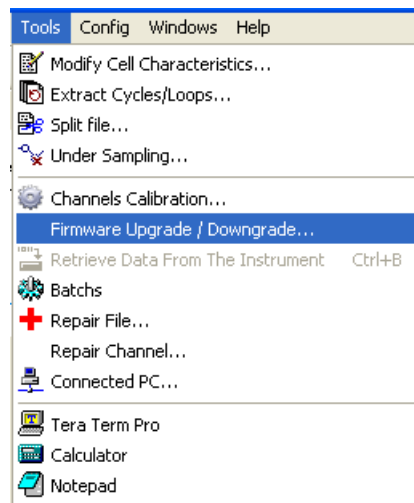

**Fig. 41: Firmware Upgrade/Downgrade tool in the “Tools” menu.**



- 4) The window displays the pathway of the current firmware flash (here: [V10.23](#)).

**NOTE:**

Since V10.33, the flash file is located in the “Program files” directory.

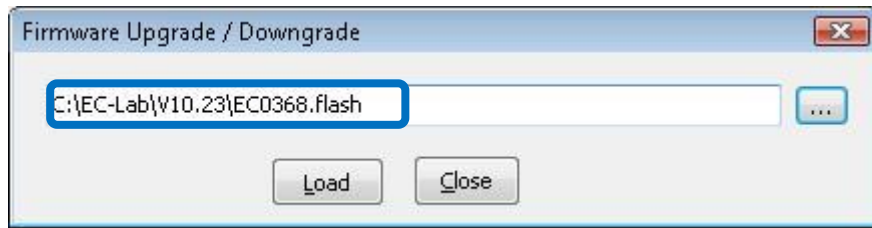
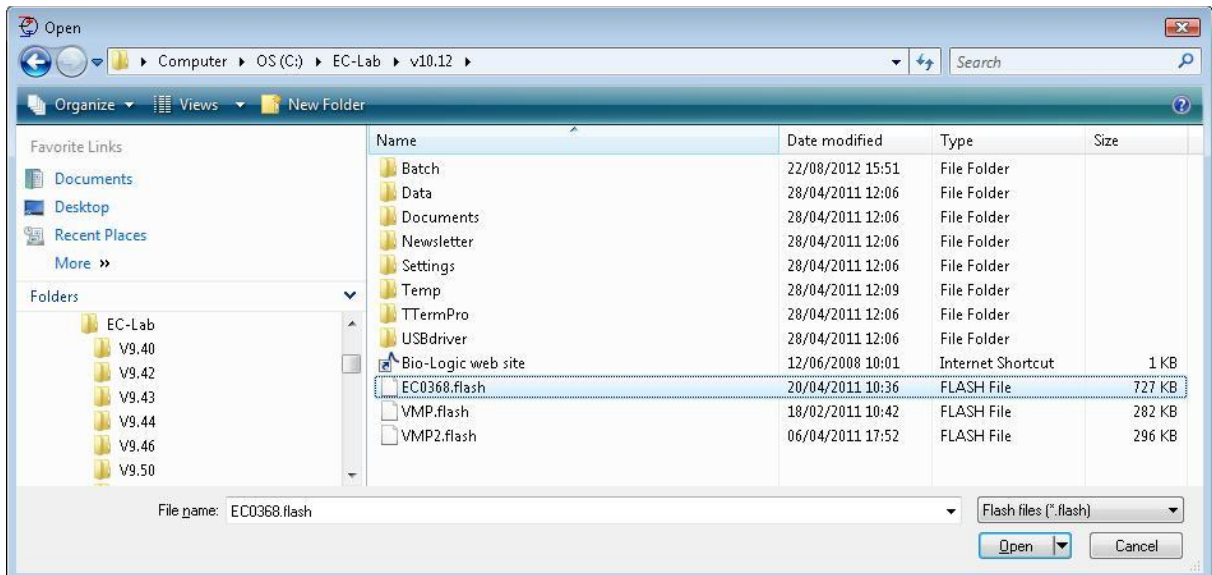

**Fig. 42: Loading of the flash.**

- 5) Click on the “Browse”  button to select the flash file (EC0368.flash) of the older version (here: [V10.12](#)). Click on “Open” when the flash is selected.

**NOTE:**

if the wrong file is selected, the communication board may be damaged.



**Fig. 43: Flash location in the EC-Lab folder.**

- 6) The pathway of the flash of the old version ([V10.12](#)) is shown in the “Firmware Upgrade/Downgrade” window.

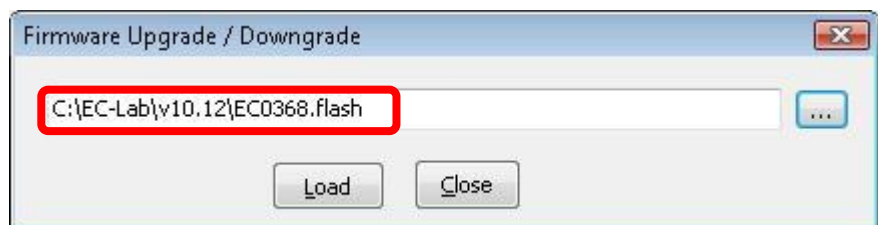

**Fig. 44: “Firmware Upgrade/Downgrade” window.**

- 7) Click on the “Load” button. A warning message shows up. Click on “OK” to continue the downgrade.



**Fig. 45: Warning message.**

- 8) The downgrade process starts and “Upgrading...” appears on the bottom of the window (but the firmware is really downgraded).

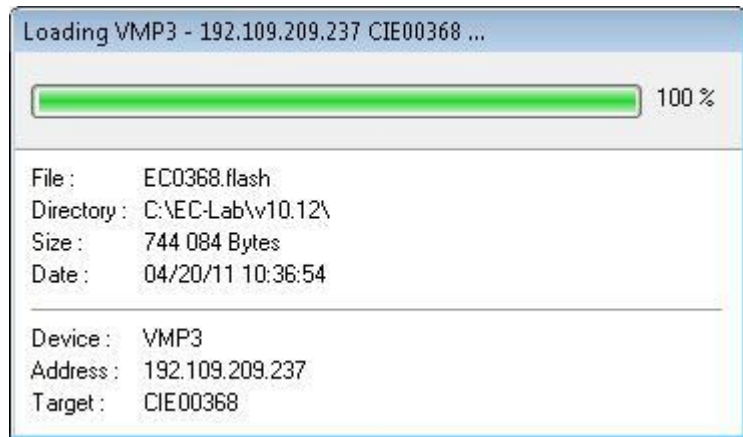

**Fig. 46: Flash loading.**



**Fig. 47: Upgrading message on the status bar.**

- 9) Close the “firmware downgrading/upgrading” window and the [V10.23](#). The downgrading procedure is now completed and you can connect the older version to the instrument.
- 10) Open the older version [V10.12](#) and connect to the instrument.

## 6 Connection to the cell

Depending if a booster or Low current is needed or not, the cell cable connection is different. The different cases are discussed hereafter in 6.1 and the connection of the cell cable to the cell is discussed in 6.2.

### 6.1 Cell cable to the potentiostat

#### 6.1.1 Connection of the standard channel board

The cell cable with a DB25 connector has to be connected on the channel board side and 5 terminals (2 mm plugs) to connect to the cell.

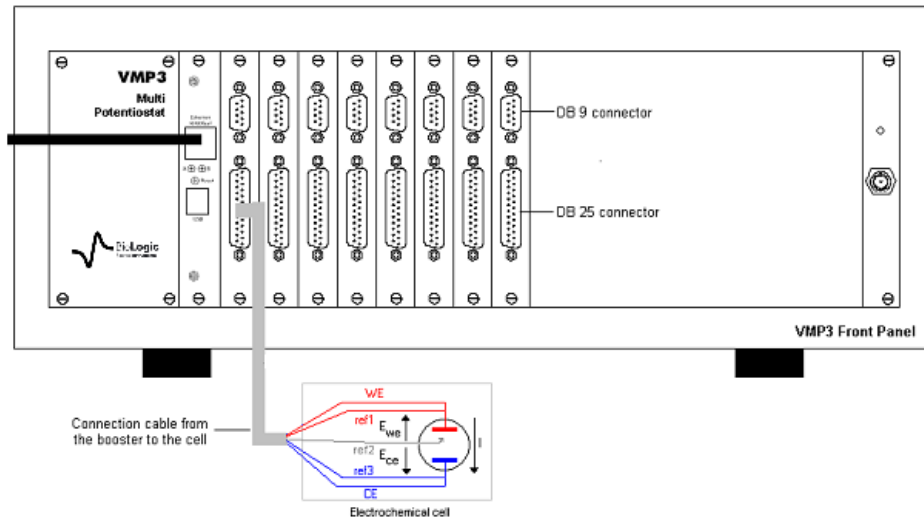

Fig. 48: Channel board connection to the cell.

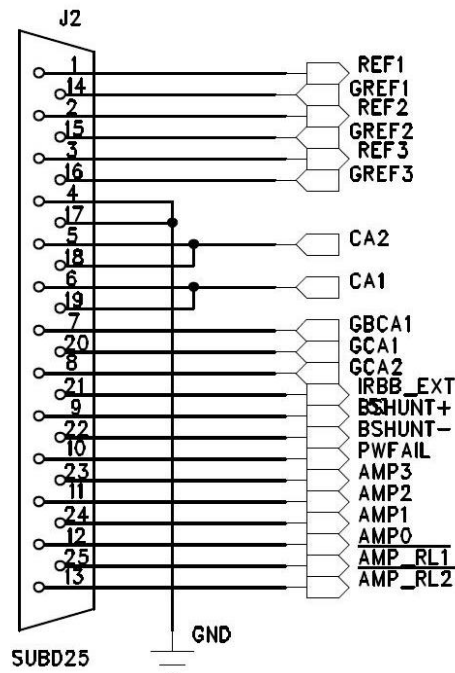
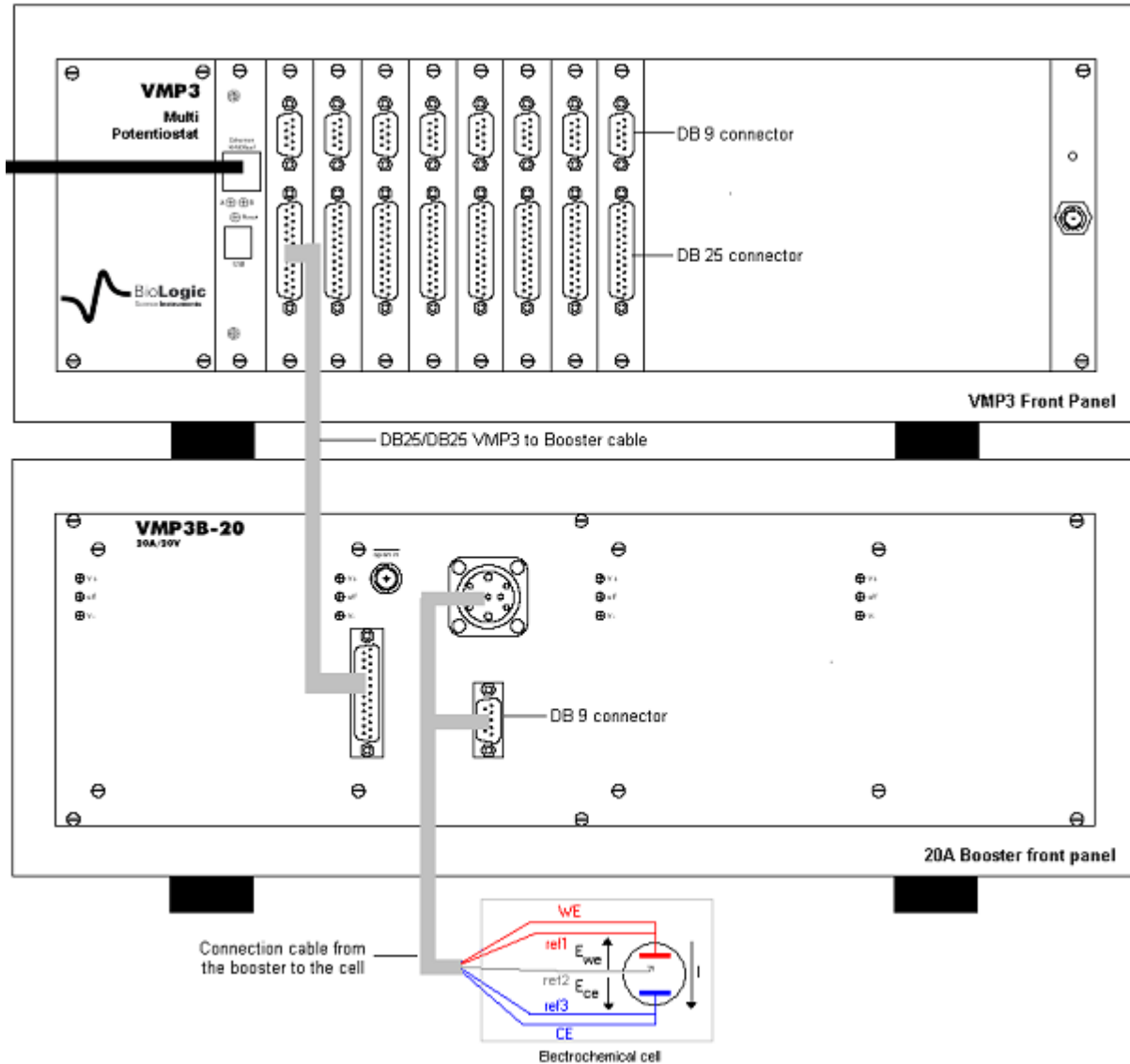

Fig. 49: DB25 structure.

### 6.1.2 Connection to the cell through a booster or Low current option

The channel of the instrument has to be connected the DB25 connector on each side. Then, the booster cell cable has to be connected to the booster.

Only a channel of SP-150, VSP, VMP3, CLBs or HCPs can be connected to a booster and only a channel of SP-150, VSP or VMP3, can be connected to the low current option.



**Fig. 50: Instrument to booster and booster to cell connections.**

The front panels of the booster are described hereafter.

### 6.1.2.1 Low current option

Channel of the SP-150, VSP or VMP3 can be equipped with the "p" low current option providing a sub-pA resolution. This option extends the current ranges down to 1 nA with a resolution better than 0.1 pA. An instrument can contain a mixture of standard channels and channels equipped with the "p" low current option. A standard channel with the "p" low current option features 10 current measurements ranges in fixed or auto-ranging mode. The "p" low current option inherits all the standard board benefits such as impedance measurements (if standard channel has the EIS option), 2 electrometers, simultaneous recording of the potential and current, high speed acquisition, DSP technology, 20 V adjustable control range, 2 auxiliary inputs per channel, and up to 5 terminal measurements.

The "p" option improves some of the specifications like the electrometers input bias current which is typically less than 100 fA or the input impedance at least  $10^{14} \Omega$  in parallel with no more than 1 pF. All these performances make an instrument with the "p" low current option appropriate for research on insulators, coatings, thin film electrodes, dielectric materials, microelectrodes, sensors, low conductive medium, and biological interfaces.

The "p" low current option physically consists of a board and an electrometer which is a small box to be placed close to the cell and cables.

Each 'p' low current option must be installed in one of the slots of the instrument. This limits the maximum number of channels all equipped with the 'p' low current option to 8 in the VMP3. The connection between the standard channel and the "p" low current option is performed using a supplied ribbon cable.

Installing a "p" low current option in an instrument is a question of a few minutes and can be performed on site (preferably by an electronic technician) providing that minimum precautions are used.



**Fig. 51: The 'p' low current option.**



**Fig. 52: Standard channel installed.**



**Fig. 53: Standard channel connected to a "p" low current board.**

### 6.1.2.2 Booster kit front panel

#### 6.1.2.2.1 2 A, 4 A and 5 A

On the 2 A, 4 A and 5 A booster kit front panel, there are:

- 4 connectors:
  - one DB25 connector dedicated to connect booster kit and potentiostat/galvanostat channel board,
  - two DB9 connectors dedicated to connect cell cable, one male connector dedicated to current control and measurement and one female connector dedicated to voltage control and measurement,
  - one BNC connector (Open in) for security input.
- 3 LEDs:
  - two green LEDs V+ and V-, switched on when the operation of the booster is correct, switched off otherwise,
  - one red LED off, switched off when the operation of the booster is correct, switched on otherwise.

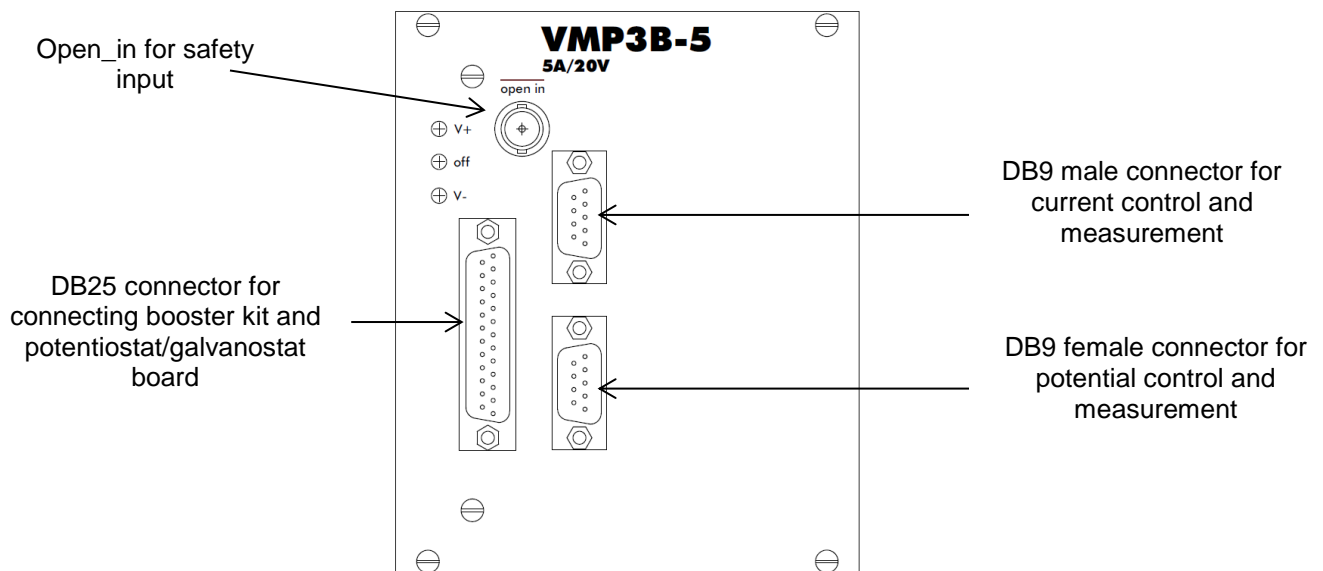

**Fig. 54: 5 A front panel.**

**Note:**

- 2 A booster is double then two modules are present in the same kit.
- 4 A booster can be installed in VSP chassis only whereas 2 A or 5A booster have to be inserted only in a booster chassis. This 4 A booster takes 2 slots and it has to be located in the slot #3 and #4 of the VSP chassis.

#### 6.1.2.2.2 10 A and 20 A

On the 10 A and 20 A booster kits (to be inserted in a booster chassis) front panel, there are:

- 4 connectors:
  - 1 DB25 connector dedicated to connect booster kit and potentiostat/galvanostat channel board,
  - 1 female DB9 connector dedicated to connect cell cable and to voltage measurement,
  - 1 female Jaeger connector to connect cell cable and to current measurement,
  - 1 BNC connector (Open in) for security input.

- 3 LEDs:
  - two green LEDs V+ and V-, switched on when the operation of the booster is correct, switched off otherwise,
  - one red LED off, switched off when the operation of the booster is correct, switched off otherwise.

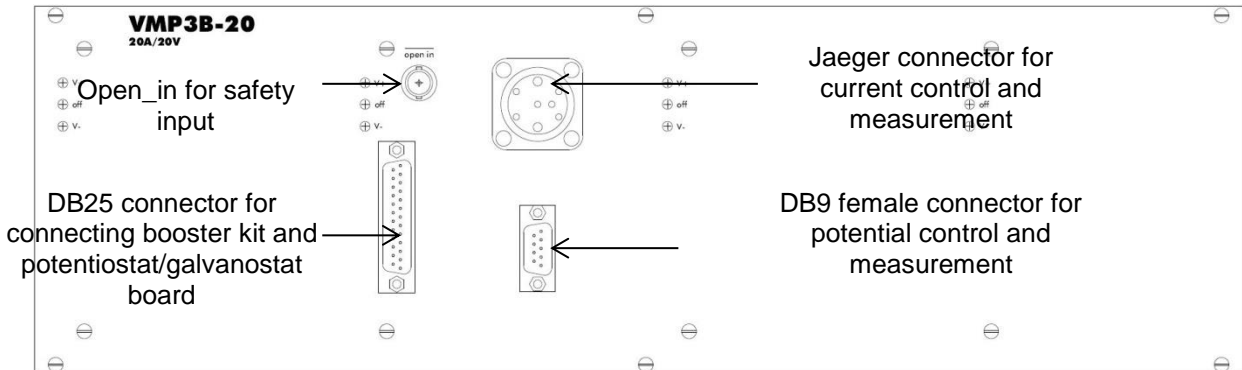

**Fig. 55: 20 A booster board.**

The booster to cell cable is 1.5 m long with a DB9 connector on the booster side and 5 terminals to connect to the cell: 2 for the current (4 mm banana plugs) and 3 for the potential (2 mm banana plugs).

**6.1.2.2.3 80 A (HCP-803 or booster 80 A)**

On the 80 A booster front panel, there are:

- 5 connectors:
  - one DB25 connector dedicated to connect booster kit and potentiostat/galvanostat channel board,
  - one male DB9 connector dedicated to connect voltage sense cable,
  - two copper bars (+ and -) to connect power cables,
  - one BNC connector (Open in) for security input,
- 3 LEDs:
  - two green LEDs V+ and V-, switched on when the operation of the booster is correct, switched off otherwise,
  - one red LED off, switched off when the operation of the booster is correct, switched on otherwise.
- 1 emergency stop push button.

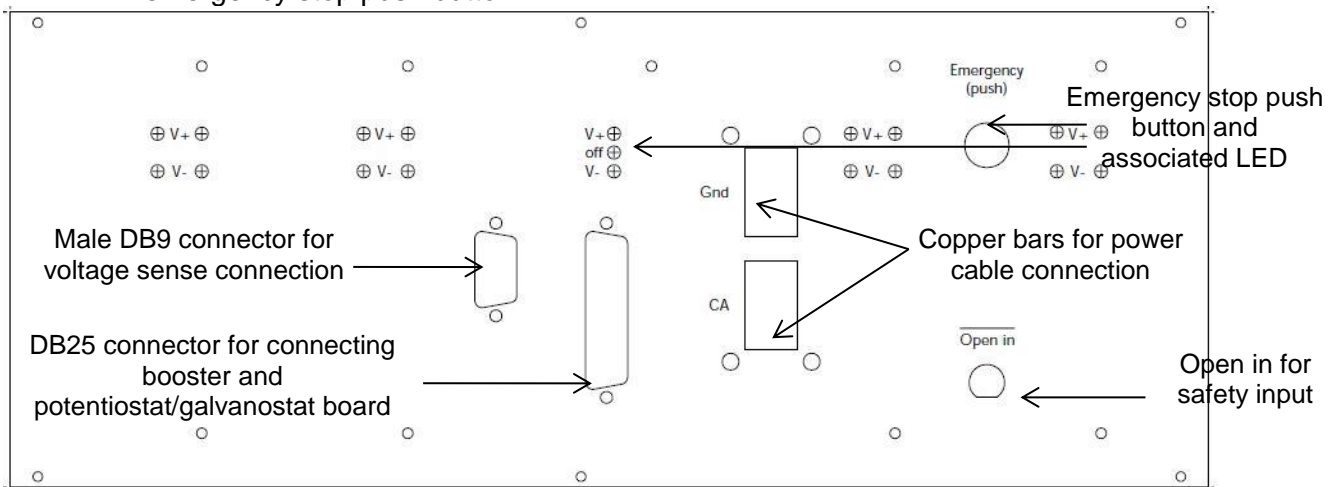

**Fig. 56: HCP-803/VMP3B-80 front panel.**

#### 6.1.2.2.4 100 A (HCP-1005 or booster 100A)

On the 100 A booster front panel, there are:

- 6 connectors:
  - one DB25 connector dedicated to connect booster kit and potentiostat/galvanostat channel board,
  - one connector dedicated to connect voltage sense cable,
  - one connector for temperature probe (DB9 connector must be connected to the standard channel),
  - two copper bars (+ and -) to connect power cables,
  - one BNC connector (Open in) for security input,
- LEDs:
  - one green LED Power, switched on when the operation of the booster is correct, switched off otherwise,
  - two red LED Off and Overheat, switched off when the operation of the booster is correct, switched on otherwise.
- 1 emergency stop push button.

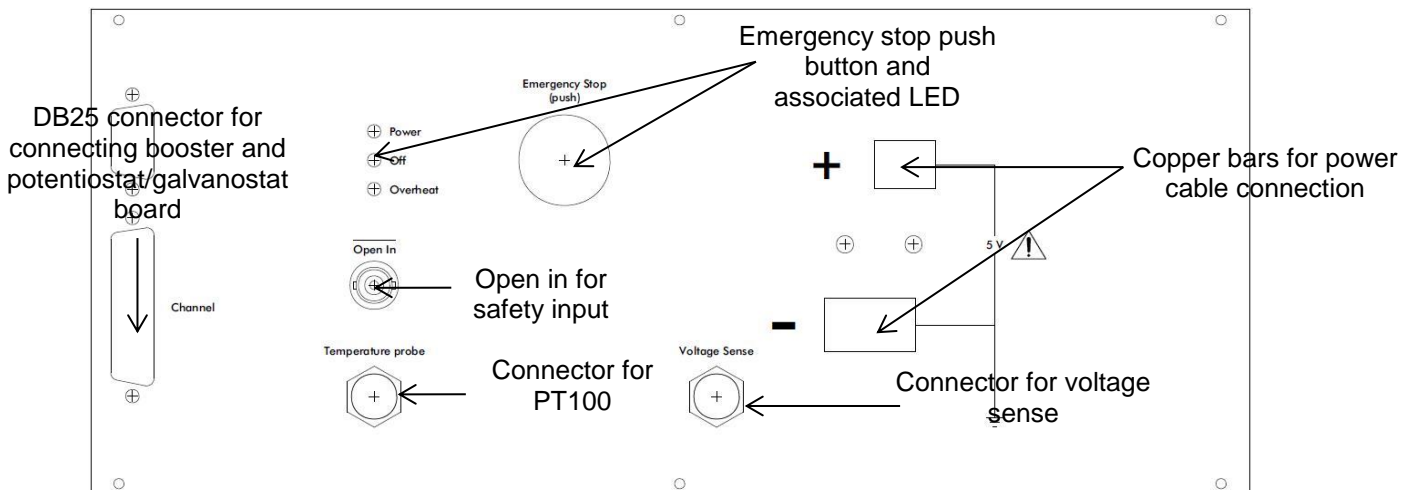

Fig. 57: HCP-1005/VMP3B-100 front panel.

#### 6.1.2.2.5 500 W load box (CLB-500 or LB-500)

On the 500 W load box front panel, there are:

- 5 connectors:
  - one DB25 connector dedicated to connect booster kit and potentiostat/galvanostat channel board,
  - one male DB9 connector dedicated to connect voltage sense cable,
  - two copper bars (+ and -) to connect power cables,
  - one BNC connector (Open in) for security input,
- 2 LEDs:
  - one green LED "On", switched on when the operation of the load is correct, switched off otherwise,
  - one red LED "Fail", switched off when the operation of the load is correct, switched on otherwise.
- 1 emergency stop push button.



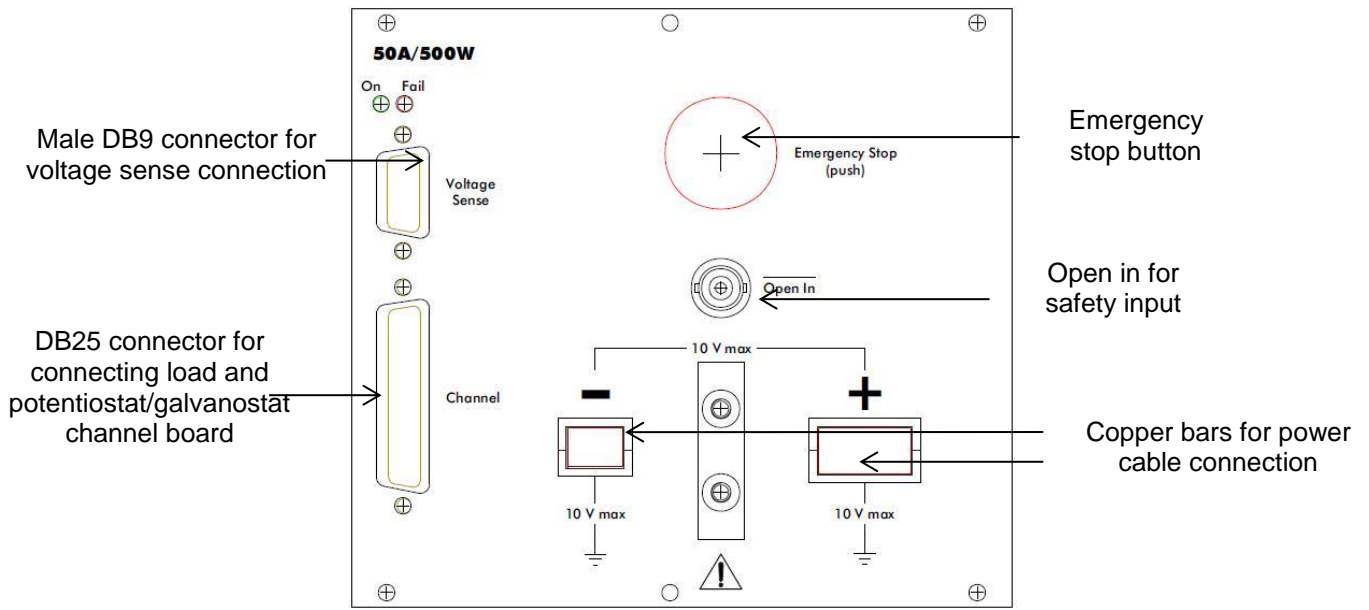

Fig. 58: CLB-500/LB-500 front panel.

6.1.2.2.6 2 kW load box (CLB-2000 or LB-2000)

On the 2 kW load box front panel, there are:

- 5 connectors are present:
  - one DB25 connector dedicated to connect booster kit and potentiostat/galvanostat channel board,
  - one male DB9 connector dedicated to connect voltage sense cable,
  - two copper bars (+ and -) to connect power cables,
  - one BNC connector (Open in) for security input,
- 2 LEDs:
  - one green LED "On", switched on when the operation of the load is correct, switched off otherwise,
  - one red LED "Fail", switched off when the operation of the load is correct, switched on otherwise.
- 1 emergency stop push button.

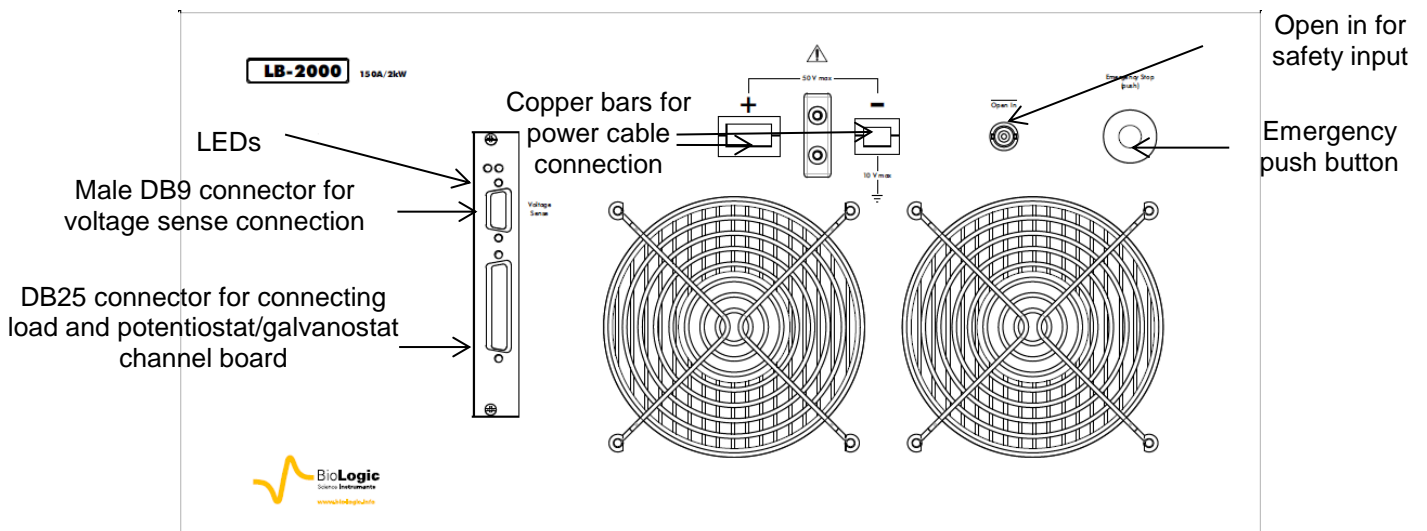

Fig. 59: CLB-2000/LB-2000 front panel.

## 6.2 Cell cable to the cell.

This paragraph explains how to connect a channel to a cell using the standard 1.5 m cable provided with the instrument.

In the standard configuration, a cell cable has 6 lead connections to the electrochemical cell: 4 are used in the cell control loop (2 for the current and 2 for the potential) while the 5<sup>th</sup> lead permits simultaneous recording an additional voltage. Additionally a 6<sup>th</sup> ground lead is provided for cell shielding purposes or for particular cell arrangements such as multi-pitting protocols. This lead is especially used in the CE to ground mode. To be easily identified, each lead has an associated color and label as follows:

- **Ref1:** RED – Reference 1 for the control and measurement of the working electrode potential.
- **Ref2:** WHITE – Reference 2 for the control and measurement of the Reference electrode potential.
- **Ref3:** BLUE – Reference 3 for the control and measurement of the Counter electrode potential.
- **CA2:** RED – Control Booster for the current control and measurement flowing through the working electrode (in standard mode).
- **CA1:** BLUE – Control Booster for the current control and measurement flowing through the counter electrode (in standard mode).
- **GND:** BLACK – Ground connected to REF1 in the CE to Ground mode.

The internal structure of the instrument has led to the building of two different connection modes: “Standard” and “CE to Ground”.

### 6.2.1 Standard connection

A channel has the possibility to link up with 2, 3 or 4 electrodes in different configurations depending on the electrochemical cell. In the standard mode  $E_{we}$  and  $E_{ce}$  are measured as follow:

$$E_{we} = \text{Ref1} - \text{Ref2}$$

$$E_{ce} = \text{Ref3} - \text{Ref2}$$

The current (defined in the positive direction) crosses the electrochemical cell from CA2 to CA1. Typical standard configurations are explained hereafter.

#### 6.2.1.1 Standard three-electrode connection

In the standard three-electrode connection mode typically used in analytical electrochemistry or corrosion experiments the working electrode is connected to REF1+CA2. The counter-electrode is connected to REF3+CA1 and the reference electrode is connected to REF2.

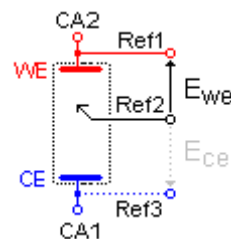

**Fig. 60: Standard three-electrode connection for a classical metal-solution interface.**

Another three-electrode connection with a reference electrode can be done, for example in batteries application. This connection allows the user to record/control simultaneously the positive and the negative part of the battery. For this, the following connection has to be done:

- Connection of the positive electrode (WE) to REF1+CA2,
- Connection of the negative electrode (CE) to REF2+CA1,
- Connection of the reference electrode (REF) to REF3.

As the potential regulation is done between REF1 and REF2, the total potential of the battery will be displayed by default. The other parameters, such as the potential of the positive and the negative electrode versus the reference electrode, can be displayed by ticking the boxes Ece and Ewe-Ece in the Cell Characteristics windows.

By this way, in the data file, the following rows will be displayed:

- Ewe related to REF1-REF2 *i.e.* total potential of the battery,
- Ece related to REF3-REF2 *i.e.* – negative electrode potential vs. Reference,
- Ewe - Ece related to REF1-REF3 *i.e.* positive electrode potential vs. Reference electrode.

It is then possible to plot change of potential (positive, negative, totality) as a function of time or state of charge (SOC).

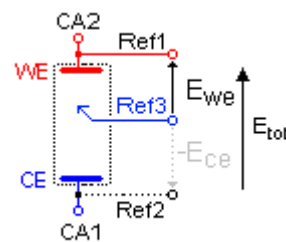

**Fig. 61: Three-electrode connection with a reference electrode.**

### 6.2.1.2 Two-electrode connection

In the two-electrode connection mode the positive electrode of the device of interest (battery, fuel cell, supercapacitor, ....etc) is connected to REF1+CA2. The potential control or measurement is performed between REF1 and REF2, and the controlled or measured current crosses the cell from CA2 to CA1. So the negative electrode has to be connected to REF2+REF3+CA1. In particular cases, to study the battery positive and negative electrode materials, the user inserts a reference electrode. Then a three-electrode assembly is required (refer to the previous part).

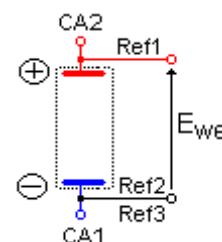

**Fig. 62: Two-electrode connection to a battery cell.**

### 6.2.1.3 Four-electrode connection

In the four-electrode connection mode the user has the ability to record the liquid-liquid interface potential ( $E_{ce}$ ), also called Kelvin probe connection.

In the standard connection mode, REF1 should always be connected to WE (or to the positive electrode) for proper cell isolation. However, to avoid an IR drop in connections, it is recommended to connect REF1 directly on the cell electrode and not to the CA2 cable.

**Note:** Connecting REF3 to CA1 adds parallel impedance. It is better to avoid it for accurate impedance measurements. So for impedance measurement, it could be better to disconnect REF3 from the cell if  $E_{ce}$  measurement is not required. Notice that in that case, it is recommended to connect REF3 to the ground cable.

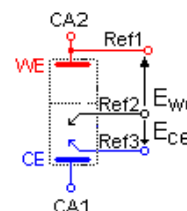

**Fig. 63: Four-electrode connection for a liquid – liquid interface.**

## 6.2.2 CE to Ground connection mode

This connection mode is chosen in the EC-Lab® software “Advanced settings” window. Then the connections must be done in a special way, in connecting the CA1 (CE) cable to the WE of the cell and the ground cable to the CE electrode of the cell, as shown below:

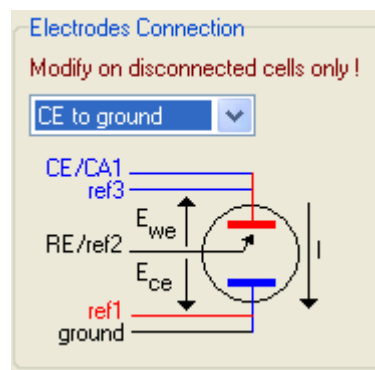

Fig. 64: CE to Ground connection mode.

### 6.2.2.1 CE to Ground with one common reference electrode

CE to Ground (or N-Stat) mode allow user to perform multielectrode measurement. Hereafter some specific cables are shown. These cables simplify the connection between the potentiostat and the cell.

The user has to set CE to Ground mode in the advanced setting tab as shown previously.

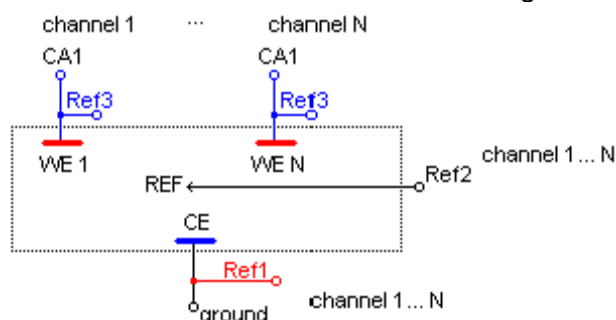

Fig. 65: CE to ground connection (several WE, 1 CE and 1 REF).

#### 6.2.2.1.1 The Bipot cable

To perform a bipotentiostat experiment with two standard boards (with or without EIS ability), a cable is available. Its part number is 092-22/12.



Fig. 66: Picture of the bipot cable.

### 6.2.2.1.2 The N-Stat Box

The N'Stat box (ref. 091-22/3) is an accessory designed for multielectrode cell applications.

Working with multielectrode cells generally implies a muddled connection. So far, the multielectrode cells connection can be done with the standard cables.

The main advantage in using the N-Stat box is to simplify the connection to cell connection. The N'Stat box also improves accuracy for low currents and high impedance measurements by providing reference electrode buffering and active shielding for the working electrode leads.

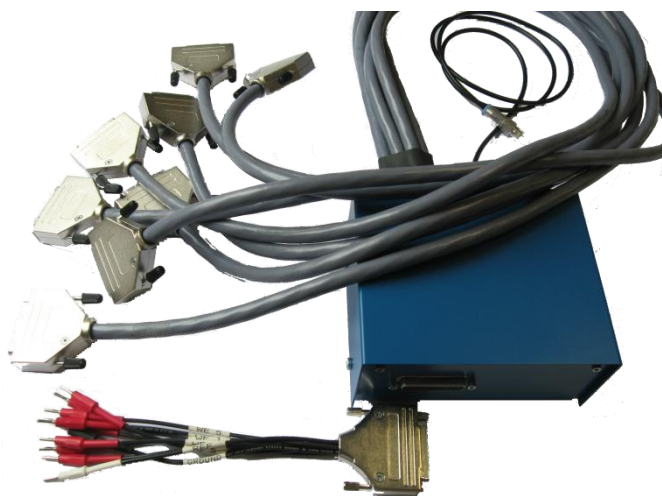

**Fig. 67: Picture of an N-stat box.**

The N'Stat box has up to 8 cables on one end. Those cables are to be connected instead of the cell cables. On the other end, there is a DB25 connector to which is attached a cell cord with individual cables.

CONNECTOR NSTAT BOX  
FRONT VIEW

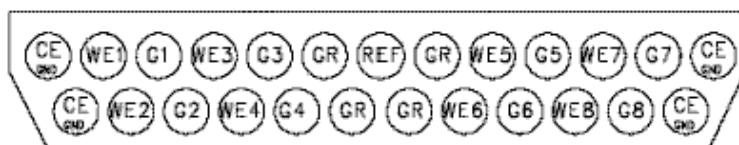

CE<sub>GND</sub> = Counter Electrode (GROUND in this mode = black banana plug)

WE<sub>n</sub> = Working Electrode (Channel 1 to 8)

G<sub>n</sub> = working electrode Guard Shield (Channel 1 to 8 green banana plug)

REF = Common Reference electrode

**Fig. 68: Structure of N-Stat box connector.**

#### 6.2.2.1.2.1 The low current N'stat Box

The Low current N-Stat box (ref. 091-22/4) (Fig. below) allows the user to connect eight working electrodes with one counter and one reference electrode via eight low current boards. This box is different from the standard N-Stat box because low current boards require a particular connection.

On one side (a) the low current N-Stat box has a connector (see below) where there is connected a printed board with eight cables (blue lead) for the working electrodes, one cable for the reference electrode (white lead) and two ground cables (black lead).

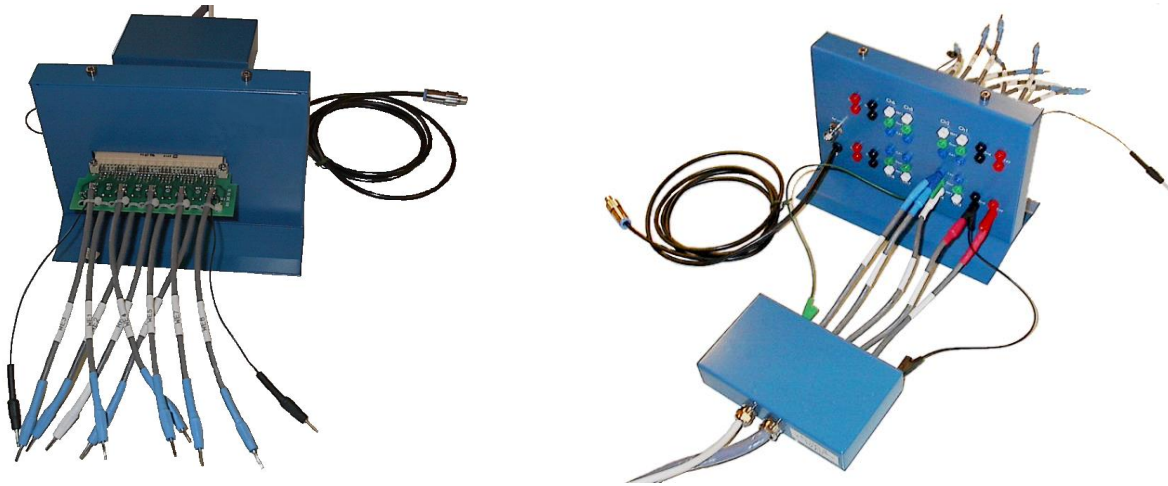

**Fig. 69: Picture of a low current N-Stat box. Left: N-Stat box Cable to electrochemical cell connection. Right: Low current board cables to N-Stat box connection.**

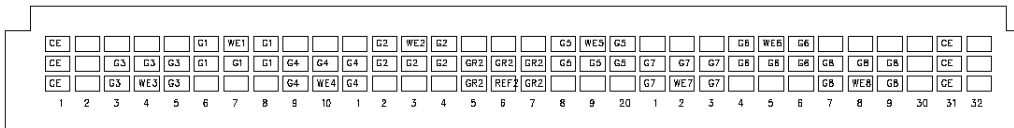

FRONT VIEW

CE<sub>GND</sub> = Counter Electrode (GROUND in this mode = black banana plug)  
 WE<sub>n</sub> = Working Electrode (Channel 1 to 8)  
 G<sub>n</sub> = working electrode Guard Shield (Channel 1 to 8 green banana plug)  
 REF = Common Reference electrode

**Fig. 70: Pin' Out of the N-Stat Box output's connector.**

On the other side (b), the low current N-Stat box has a power supply cable that must be connected to the INSTRUMENT front panel and 40 plugs (5 per low current board). The connections of the low current board cables to the low current N-Stat box are described in the following table.

**Tab 2: Low current board to low current N-Stat box connections.**

Low current board cables		Low current N-Stat box	
Cable Name	Color	Cable Name	Color
CE/CA1+ Ref 3	Blue	CA1	Blue
Ref 2	White	Ref 2	White
Guard shield	Green	Gca1	Green
Ref 1+Ground	Red + Black	GND	Black
CA2	Red	CA2	Red

### 6.2.2.2 CE to Ground mode with N reference electrodes

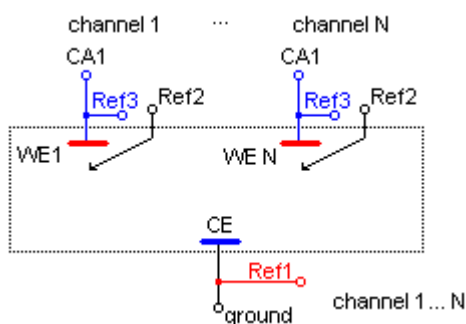

**Fig. 71: CE to ground (N-Stat) connection (1 CE, several WE and several RE).**

**WARNING!!** The cells should be connected only after the N-Stat mode has been set, else the open circuit voltage may not be properly measured.

Thus, to configure channels from the standard mode to the N-Stat mode, one must follow this procedure:

- check that the cells are disconnected from the instrument,
- switch the instrument channels to N-Stat mode (by grouping them),
- connect the electrodes for the N-Stat mode.

#### **CELL SAFETY!!!**

DISCONNECT THE CELL FROM THE INSTRUMENT WHEN THE INSTRUMENT IS POWERED OFF.

When the instrument is powered off, the current leads are open by relays but the reference inputs leads are not. The references inputs impedance are not predictable (not  $10^{12} \Omega$ ). The cell must be connected **after** the instrument is powered on, and the cell must be disconnected **before** the instrument is powered off to avoid cell damage (except for the testing box).

### 6.2.3 Specific connection for high current boosters and load boxes.

#### 6.2.3.1 80 A booster

Before switching on the HCP-803/VMP3B-80, the user has to connect all the cables to the instrument's front panel as shown previously:

- Connect the linking cable with two DB25 connectors between the standard channel board and the booster.
- Connect the potential cable with a DB9 connector and 3 banana plugs to the booster for the potential measurement. Connect the red and white cables on the negative terminal of the cell and the blue cable on the positive terminal of the cell.
- Connect the black power cables ( $\varnothing$  1 cm) to the power bar plugs. Screw the cables with Key (10).
- Connect the Ethernet cable or USB cable to the communication board.
- Connect the power cord to the rear panel and turn on the instrument.

When the computer connects to the HCP-803 or to the instrument connected with VMP3B-80, the software will automatically recognize HCP-803/VMP3B-80 and turn to the CE to Ground connection mode (only if the booster is connected to the channel board). If the channel board of the HCP-803 is used alone without the booster, then the software remains in the standard connection mode.

This connection mode is automatically locked in the EC-Lab<sup>®</sup> software “Advanced settings” window when the 80 A booster unit is detected by the software (connected to standard channel board). The connections must be done in a special way, in connecting the CA1 (CE) cable to the WE of the cell and the ground cable to the CE electrode of the cell.

The positive electrode must be connected to the power cable on the “CA” plug and the negative electrode must be connected to the “Ground” plug.

The potential measurement can be made directly on the positive and negative electrodes or on other wires specifically dedicated. On the potential measurement cable (DB9 with 3 bananas on the other side), Ref3 (blue) is connected to the positive electrode (working electrode in “CE to ground” mode) and Ref2 and Ref1 are connected to the negative one. It is the same connection for a standard battery only using the “CE to Ground” mode.

This is shown below:

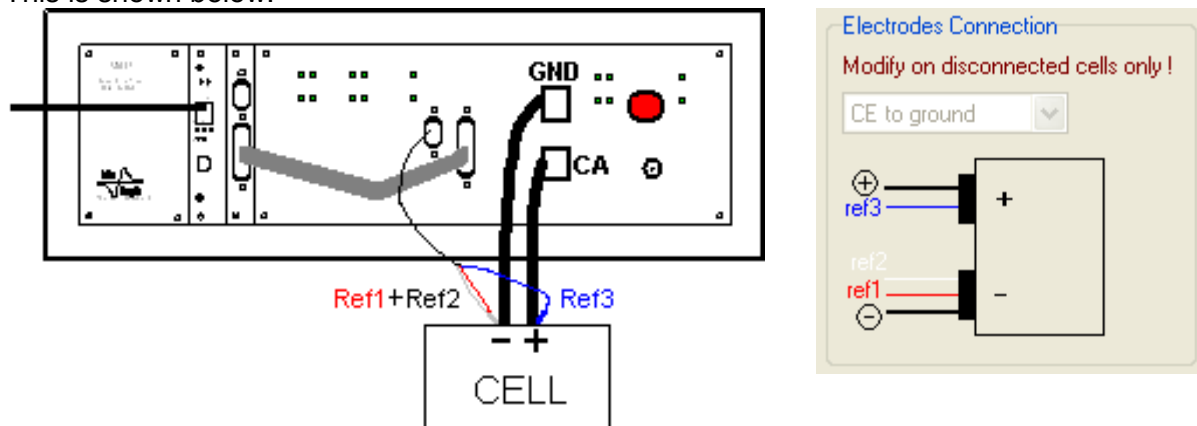

Fig. 72: Two-electrode connection for the HCP-803 in the CE to Ground mode.

### 6.2.3.2 100 A booster

Before switching on the HCP-1005/VMP3B-100, the user must connect all the cables on the instrument's front panel as shown below.

- Connect the linking cable with two DB25 connectors between the standard channel board and the booster.
- Connect the potential cable to the booster for the potential measurement.
- Connect the black power cables ( $\varnothing$  1 cm) to the power bar plugs. Screw the cables with Key (10).
- Connect the Ethernet cable or USB cable to the communication board.
- Connect the power cord to the rear panel and turn on the instrument.

When the computer connects to the HCP-1005 or to the instrument connected with VMP3B-100, the software will automatically recognize HCP-1005/VMP3B-100 and turns on the CE to Ground connection mode (only if the booster is connected to the channel board). In the other case, the channel board of the HCP-1005 is used alone without the booster, and the software remains in the standard connection mode (see the next section).

The CE to Ground connection mode is automatically locked in EC-Lab<sup>®</sup> software's “Advanced settings” window when the 100 A booster unit is detected by the software (connected to standard channel board).

Let us consider the connection of the current wires. The positive electrode must be connected to the power cable on the “+” plug and the negative electrode must be connected to the “-” plug.

The potential measurement can be made directly on the positive and negative electrodes (usual) or on other wires specifically dedicated. On the potential measurement cable, Ref1 (red) is connected to the positive electrode and Ref2 and Ref3 are connected to the negative one. This connection is explained on the “Advanced Settings” window.



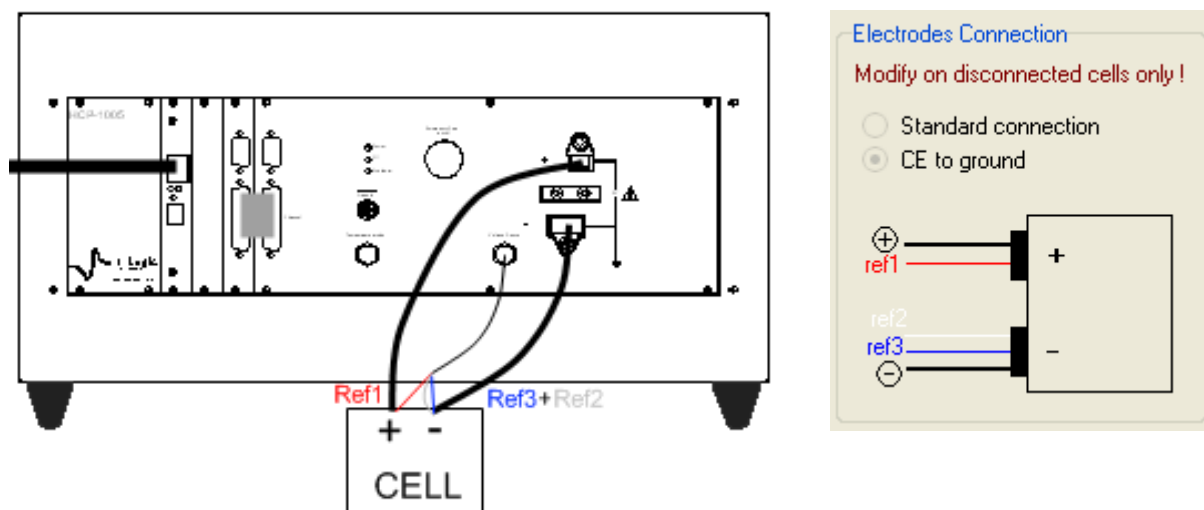

Fig. 73: Two-electrode connection for the HCP-1005 in the CE to Ground mode.

### 6.2.3.3 500 W load box

Before switching on the CLB-500/LB-500, the user must connect all the cables on the instrument's front panel:

- Connect the linking cable with two DB25 connectors between the standard channel board and the load.
- Connect the voltage cable with a DB9 connector and 3 banana plugs (blue, red and white) to the load for the potential measurement. The blue one is connected to the + of the studied system and the white and the red ones are connected to the - of the studied system.

**WARNING:** A wrong connection may damaged the cell.

- Connect the black power cables ( $\varnothing$  1 cm) to the power bar plugs. Screw the cables with Key (10).
- Connect the Ethernet cable or USB cable to the communication board.
- Connect the power cord to the rear panel and turn on the instrument.

Note: by default the connection mode of the CLB-500 and of the LB-500 is CE to ground mode.

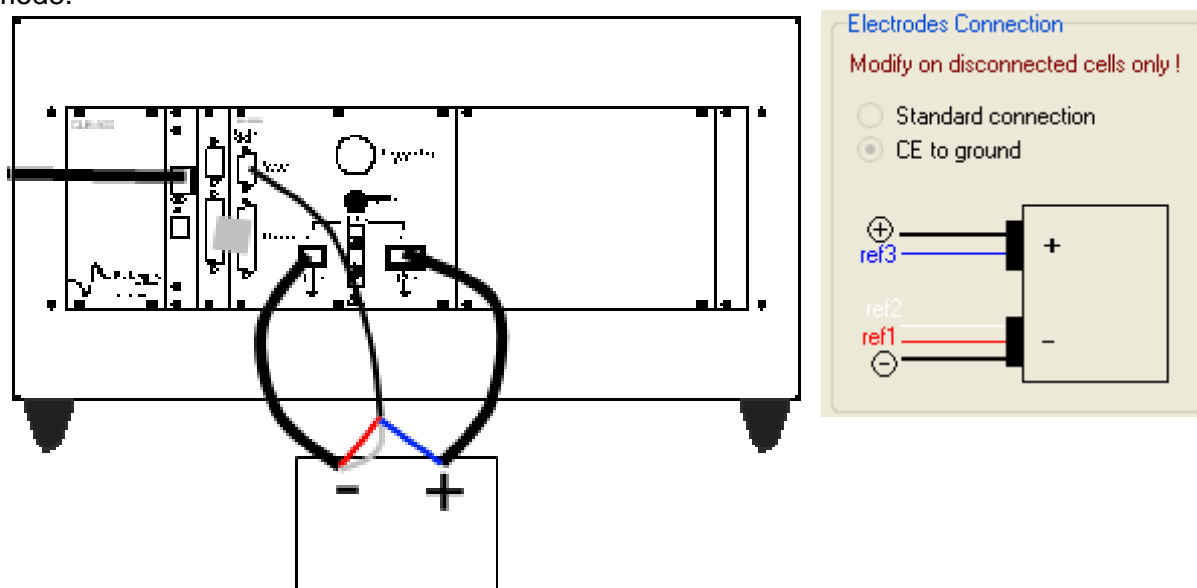

Fig. 74: Two-electrode connection for the 500 W in the CE to Ground mode.

### 6.2.3.4 2 kW Load box booster

Before switching on the CLB-2000/LB-2000, the user must connect all the cables on the instrument's front panel:

- Connect the linking cable with two DB25 connectors between the standard channel board and the load.
- Connect the potential cable with a DB9 connector and 3 banana plugs to the load for the potential measurement. The +++ cable is connected to the + of the studied system and the --- cable and the REF cable are connected to the - of the studied system.
- Connect the black power cables ( $\varnothing$  1 cm) to the power bar plugs. Screw the cables with Key (10).
- Connect the Ethernet cable or USB cable to the communication board.
- Connect the power cord to the rear panel and turn on the instrument.

Note: By default the connection mode of the CLB-2000 and of the LB-2000 is the CE to ground mode.

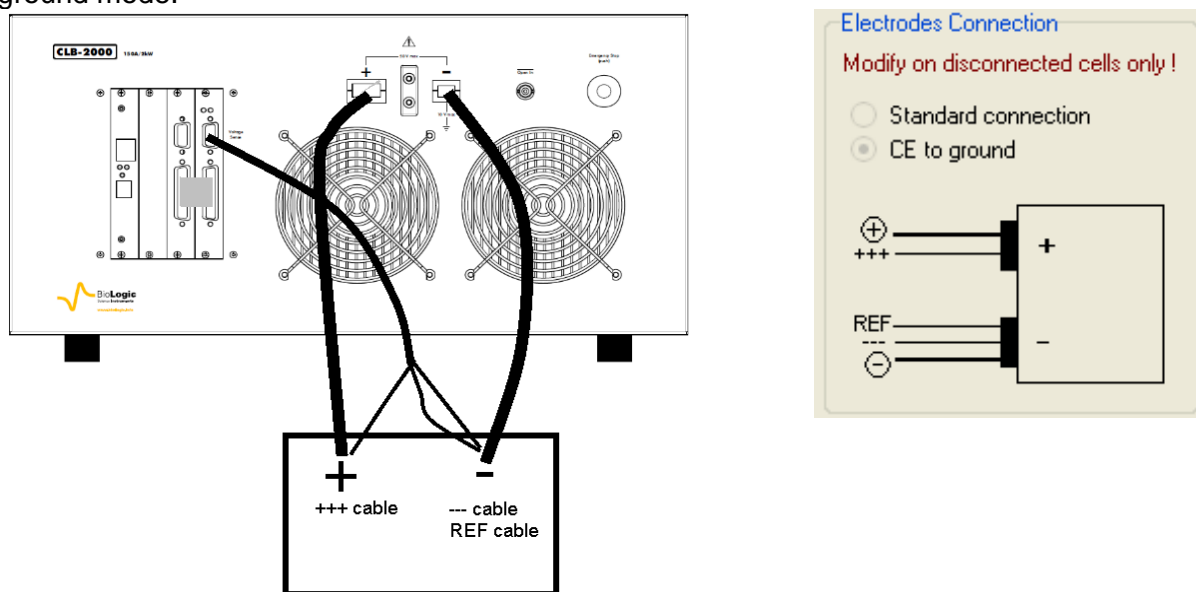

Fig. 75: Two-electrode connection for the 2 kW in the CE to Ground mode.

## 6.3 Auxiliary inputs/outputs (DB9)

The following figure shows the structure of the DB9F connector and the different pins that can be used as auxiliary inputs/outputs.

- **Analog Out** is used to control external device (1 mA max).
- **Analog In1** and **Analog In2** are general analog inputs used for auxiliary signal (voltage) recording. Activate Record Aux1 and Record Aux2 in the cell characteristics window to record these variables in the data file.
- **Trigger In** and **Trigger Out** are programmed in the experiment protocol. Trigger In can be used to start or stop the experiment of electrochemistry. In that case another instrument sends a trigger to the instrument. Trigger Out can be sent at the beginning or the end of the experiment. It is used to start or stop an experiment on another instrument.

The Trigger signals have high and low levels:

+ 3.5 V < Trigger high level < + 5 V

0 V < Trigger low level < 0.8 V

- **E monitor** (not available, HCP & CLB series) and **I monitor** are outputs that visualize I and E on a scope. The output variables are opposite to the real measured values.
- **OPEN In** is an external Trigger signal (active high) that can open the relays providing a 0 A current in the cell. For example, an emergency stop may come from an external event.
- **Ground** is tied to the earth.

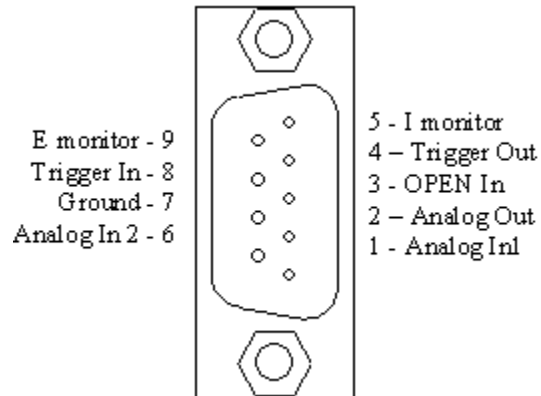

Fig. 76: Structure of the DB9 connector.

For convenience we have designed a 50 cm cable that connects to the DB9 connector of a channel on one end with 8 BNCs on the other end.

The available signals are: E monitor, I monitor, Trigger In, Trigger Out, Analog In1, Analog In2 and Analog Out



Fig. 77: DB9-8BNC cable.



## 7 Advanced features

### 7.1 External device control and recording

#### 7.1.1 General description

The EC-Lab<sup>®</sup> software offers the user the ability to control external devices such as rotating electrodes and thermostatic baths and to record external analog signals through the auxiliary DB9 connector. The user has to configure the analog output to control an external device and configure the Analog In1 and Analog In2 inputs to record external signals. Our instruments can control and record analog signals from – 10 to + 10 V. Most external devices work in a 0 to + 5 V range. The figure below shows the external device window where the user sets parameters. Many instruments are already configured in the software to be controlled by our potentiostat. This list continues to be expanded in new versions of EC-Lab<sup>®</sup> software. To configure external devices select “**External Device**” frame.

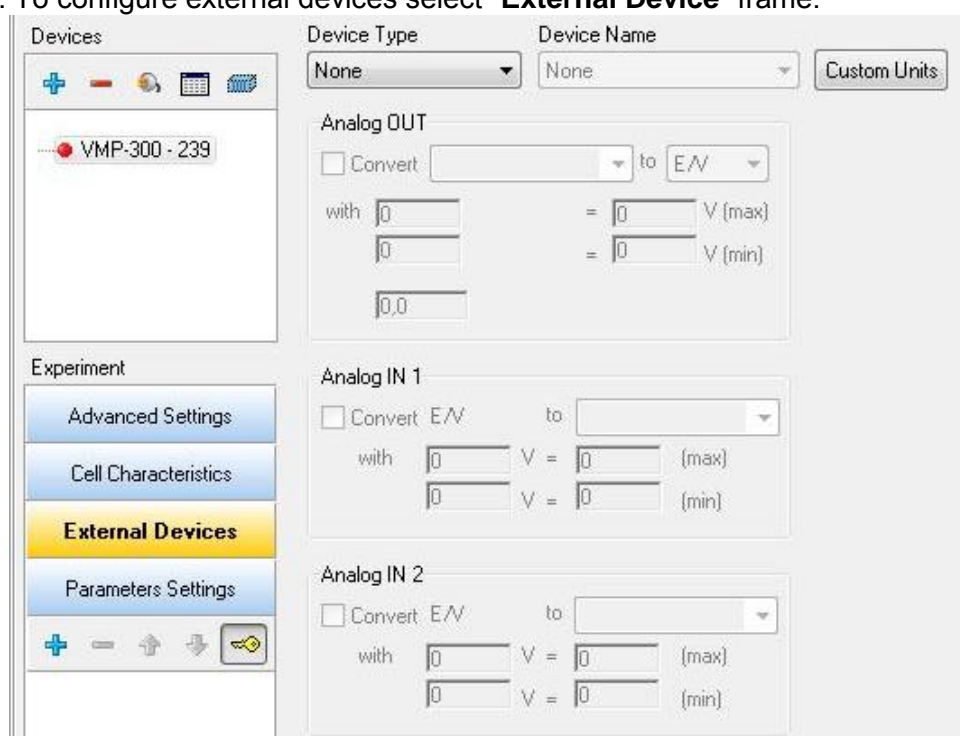
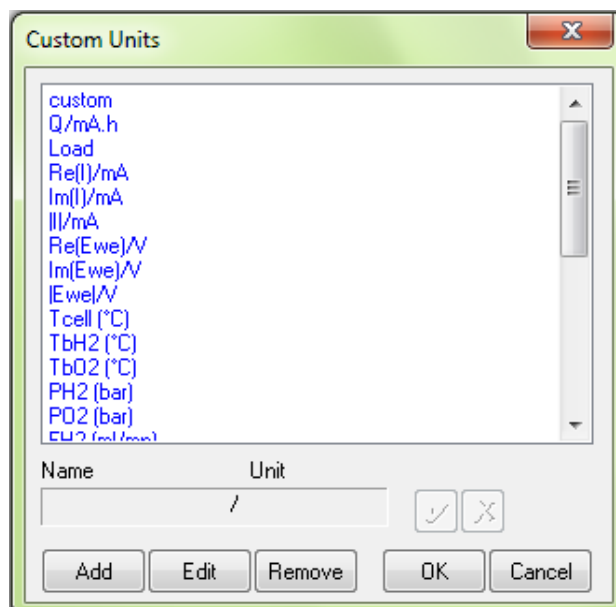

**Fig. 78: External device configuration window.**

The user must define several parameters to configure the external device to either be controlled via the analog output (left column) or record/measure data via analog input 1 and 2 (right column). The procedure for the configuration of the auxiliary inputs/outputs is described as follows:

- 1- Choose the channel to configure. Each channel can be configured for a specific device. One channel can control one device and the other one another device.
- 2- Select the Device Type in the list between None, Thermostat, RDE, QCM and other. According to the selected device type one or several device names are available.
- 3- Among the available devices some can be controlled by the analog output and some of them can only be used to record values with analog inputs 1 and 2. The user must tick the box to activate the input/output.
- 4- In the activated frame, the user must define the conversion between the input voltage and the variable to plot. This is a direct linear conversion in the range defined by the user between the min and the max value.

- 5- The user can also define the name and the unit of the variable he wants to display. Click on “**Custom Variables**”. The figure below is displayed:



**Fig. 79: Custom Units window to define new variables.**

To create a new variable with its unit, click on “**Add**” and put the name and the unit of the new variable in the frame. Then click on  to validate. The new variable is displayed in the list in blue (as a custom variable) and can now be selected as the recorded variable for the analog inputs.

- 6- Finally click on “**Configure**” to configure the selected channel to record the auxiliary input signal

The new selected variables for Analog In1 and Analog In2 are automatically displayed on the “Cell characteristics” window and activated for recording. In the “**Selector**” the created variables are displayed and can be plotted. These auxiliary variables can be used in several protocols as conditional limits of an experiment.

**Note:**

- The parameters set in Analog In1 and Analog In2 to define the linear slope can be inverted to have an opposite variation of the recorded value with the plotted value.
- The configurations of external devices that can be controlled by the potentiostat (analog output) are described in detail in the corresponding sections of the manual.
- A manual control of external devices is also available on the right of the panel.
- When a channel has been configured to control an external device, this device can be seen in the global view.

### 7.1.2 Rotating electrodes control

The instrument can control a rotating electrode such as a ALS-RRDE-3A Rotating Disk electrode model with the auxiliary input/output. A specific control panel has been designed to control the rotating speed. Note that no measurement of the rotating speed is available. This model of rotating electrode (ALS-RRDE-3A Rotating Disk electrode model) is designed to work with either one.



**Fig. 80: ALS-RRDE-3A Rotating Disk electrode**

#### 7.1.2.1 Connections

Two cables are necessary for the connection, the cell cable and a special cable for RRDE with DB-9 connector. This cable has a DB9 connector on one end and three wires named Analog Out, Trigger Out and 1 Ground on the other end (PN: 092-22/11).

The connecting procedure is the following:

- Connect the Auxiliary Input/Output of the channel board with the DB9 cable.
- Connect the “Analog Out” wire to the “Motor” plug available on the rear panel of the RRDE-3A.
- Connect the “Ground” wire to the “GND” plug available on the rear panel of the RRDE-3A.
- If user wants to control the purge of the RRDE-3A, connect the “Trigger Out” to the “Purge” plug available on the rear panel of the RRDE-3A.
- Connect REF1 and CA2 wires to the disk brush, REF3 and CA1 wires to the counter electrode, and REF2 wire to the reference electrode. For RRDE experiment, CE to Ground mode as to be selected. In that case, use the appropriate connection for both channels.

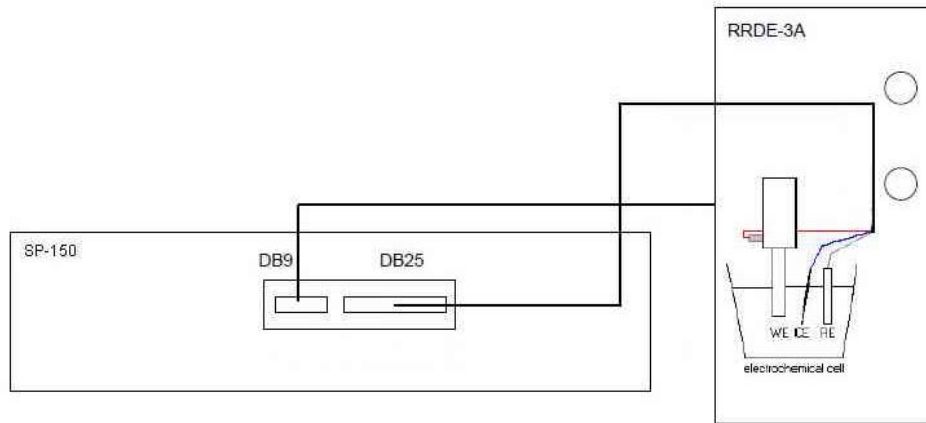

Focus on the rear panel:

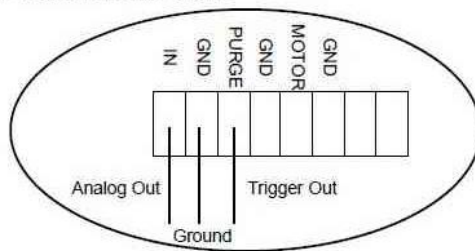

**Fig. 81: ALS-RRDE-3A Rotating Disk electrode connection to the cell cable.**

**Note:**

This menu is available only if channels designed to drive a RDE are currently connected to the RDE. If so, click on “External Devices” and the following window will be displayed:

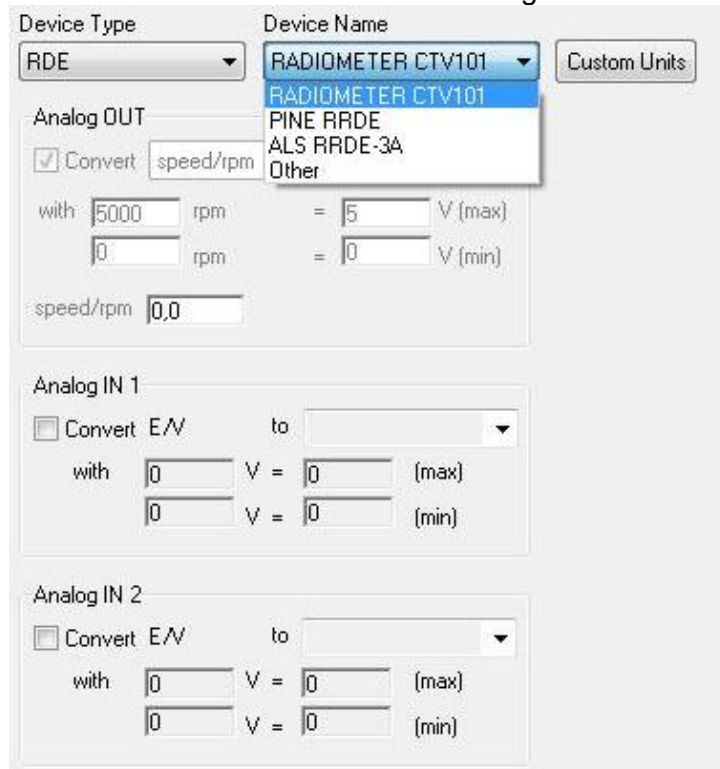

**Fig. 82: Rotating electrode control configuration.**



Under **RDE** type, one can select the standard supplied ALS-RRDE-3A, PINE RRDE or RADIOMETER CTV101 electrodes rotator. For these devices, the calibration parameters are factory set. Other external systems can be used but are not available. They will be added onto the list upon request. Note that the calibration parameters for the already selected device are not available. Nevertheless if you select another device, it is possible in the “**Analog OUT**” window to define the control parameters. Click on the **Apply** button to validate the settings. Note that this menu can be activated without any rotating electrode unit, but will only have effects on the electrochemical instruments equipped with a rotating system.

### 7.1.3 Temperature control

Temperature control is possible with the auxiliary output voltage of the instrument. Several thermostats have already been configured such as the Julabo series and the Haake Phoenix series.

The screenshot shows a configuration window for a thermostat. At the top, 'Device Type' is set to 'Thermostat' and 'Device Name' is 'Haake Phoenix series'. There is a 'Custom Units' button. Below this are three sections for analog input/output configuration:

- Analog OUT:** The 'Convert' checkbox is checked. The unit is set to 'T/°C' and converted to 'E/V'. The scale is defined as 400 °C = 10 V (max) and -100 °C = 0 V (min). A current temperature of 10.0 °C is shown.
- Analog IN 1:** The 'Convert' checkbox is checked. The unit is set to 'E/V' and converted to 'T/°C'. The scale is defined as 10 V = 400 °C (max) and 0 V = -100 °C (min).
- Analog IN 2:** The 'Convert' checkbox is unchecked. The unit is set to 'E/V' and converted to 'T/°C'. The scale is defined as 0 V = 0 °C (max) and 0 V = 0 °C (min).

**Fig. 83: Haake Phoenix series thermostat control configuration.**

The user can configure other thermostats to only record temperatures (Analog In) or to both control (Analog Out) and record (Analog In) temperature.

### 7.1.4 Electrochemical Quartz Crystal Microbalance coupling

The SEIKO EG&G QCM 922 quartz crystal microbalance has been coupled with our potentiostat / galvanostat to record both the frequency variation and the resistance variation. The configuration for the EQCM coupling is described in the following figure:

Device Type: QCM Device Name: SEIKO EG&G QCM922 Custom Units

Analog OUT

Convert T/°C to E/V

with 0 °C = 0 V (max)

0 °C = 0 V (min)

T/°C 10.0

Analog IN 1

Convert E/V to Delta(Freq)/Hz

with 10 V = 200 Hz (max)

-10 V = -200 Hz (min)

$\Delta f$  range +/- 200 Hz

Analog IN 2

Convert E/V to Delta(R)/Ohm

with 10 V = 1000 Ohm (max)

-10 V = -1000 Ohm (min)

$\Delta R$  range 1 kOhm

**Fig. 84: SEIKO EG&G QCM-922 configuration window.**

One can see that both frequency and resistance variations are recorded on the potentiostat analog inputs. The user has to define both the frequency range and the resistance range. The results of this experiment are displayed on the left.

A process is also available to calculate the amount of species electro-disposed on the quartz. To use this process, select the process data option in the Analysis menu.

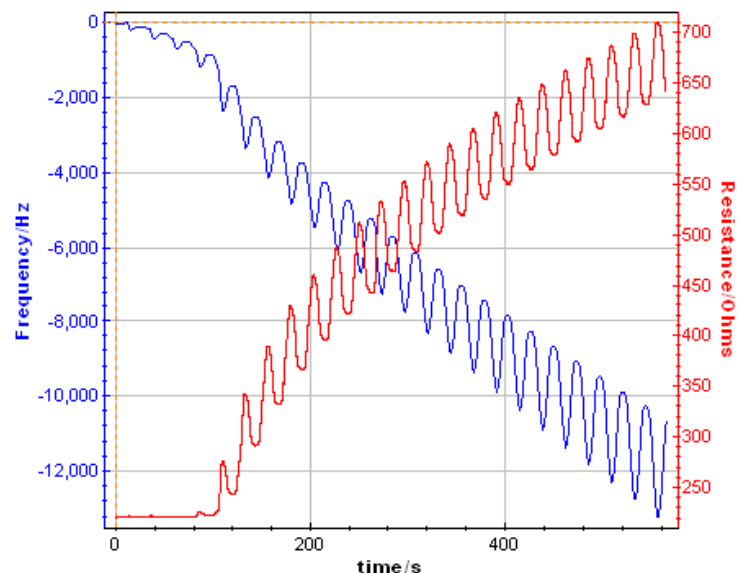

**Fig. 85: Frequency and resistance variations recorded from the analog inputs for an instrument coupled with a SEIKO EG&G QCM 922.**

## 7.2 Virtual potentiostat

The user can work with the EC-Lab<sup>®</sup> software without being connected to an instrument. In that case, the software sees a virtual potentiostat that is not available for experiments but can be used as a user's interface. The user can select his virtual instrument in the “**Devices**” frame, click on the “**Virtual potentiostat**” button . Then, the corresponding software interface will be displayed.

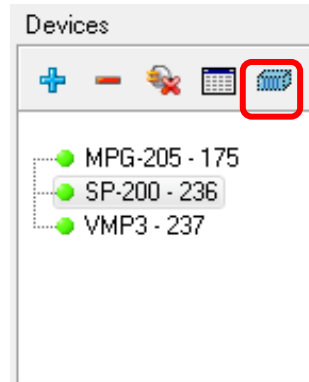

**Fig. 86: Virtual potentiostat button (in the red rectangle).**

The available techniques and time base are different according to the instrument selected.

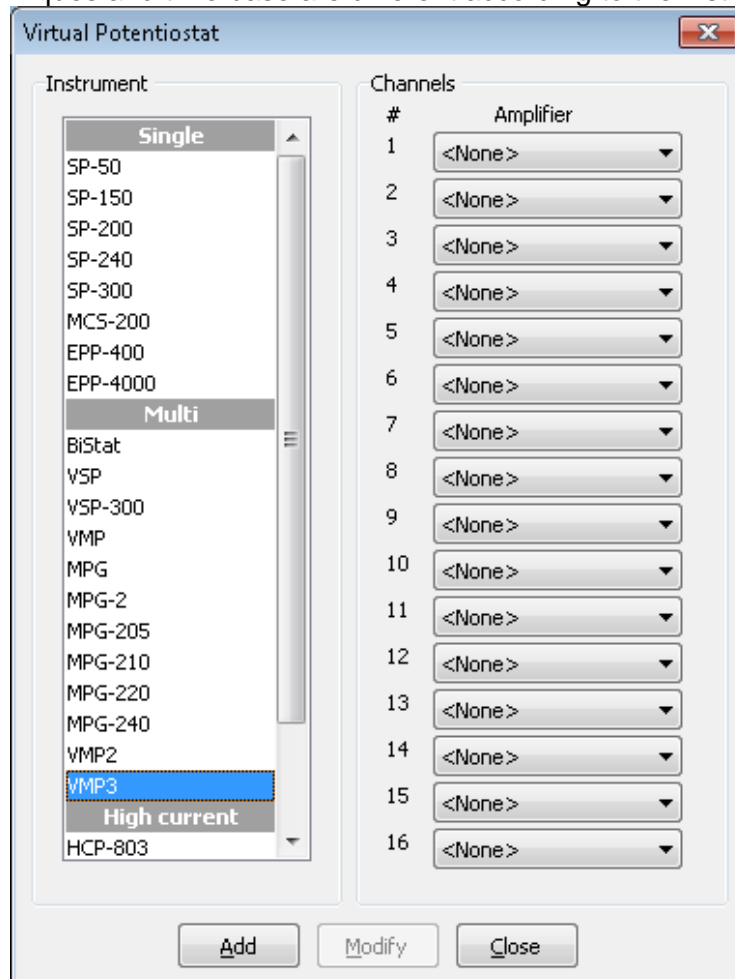

**Fig. 87: Virtual potentiostat window.**



## 8 The accessories

The accessories are described in this paragraph. These accessories can be used to check the instruments or to help the user to optimize the setup .

### 8.1 Test boxes for calibration check and user's training

#### 8.1.1 Dummy Cell 2 (DC2)

The Dummy Cell2 is provided with each channel board. The circuitry is made of resistor (accuracy 1%) and capacitor.

On the left side, two lugs have been added while two holes have been done on the right side. This way, several DC-2s can be bound together.

Dummy cell for booster and DC2 can be bound together as well.



Fig. 88: Dummy Cell-2

#### 8.1.2 Dummy cell for booster

The Dummy cell for booster is especially dedicated to check periodically a booster. The dummy cell for booster is provided with each booster chassis.

Dummy cell for booster and DC2 can be bound together as well.

Characteristics of dummy cell are given in the following table:

Resistance/mΩ	Standard tolerance	Temperature coefficient
5	1%	+/- 50 ppm/°C

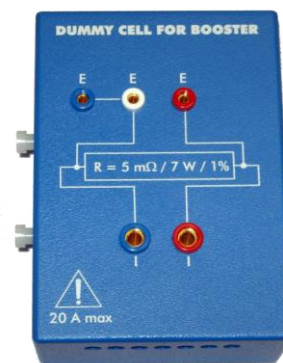

Fig. 89: Dummy Cell for Booster.

### 8.1.3 Test Box 2

The Test Box 2 is a tool that checks the calibration of our instruments. This testing box is made of one electrical circuit with high precision resistors for calibration check and two dummy cells circuits for user's training. It has been specially designed to check the calibration of the standard channel boards of our instruments. The high precision resistor circuit is made with 7 resistors in order to check each current range of the board.

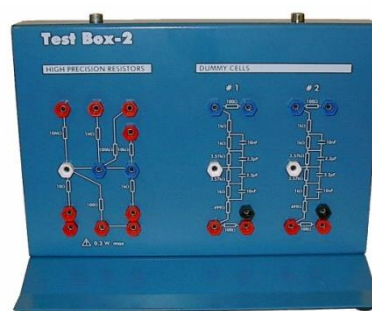

Fig. 90: TestBox-2.

High precision resistor Characteristics:

High precision resistor	I range	INSTRUMENT
10 Ohms +/- 0.04%	1 A	×
100 Ohms +/- 0.02%	100 mA	×
1 kOhms +/- 0.02%	10 mA	×
10 kOhms +/- 0.02%	1 mA	×
100 kOhms +/- 0.02%	100 $\mu$ A	×
1 MOhms +/- 0.02%	10 $\mu$ A	×
10 MOhms +/- 0.04%	1 $\mu$ A	×

**for the "p" low current option**

### 8.1.4 Test Box 3

The Test Box 3 is a tool for learning and practice on linear and non-linear electrochemical systems. This testing box is made of three electrical circuits simulating real electrochemical systems. Along with the application notes #8 and #9 the Test Box 3 can be used to highlight some usually overlooked items about the electrochemical impedance spectroscopy. By the means of the Test Box 3 some general electrochemistry protocols like Cyclic Voltammetry and, corrosion techniques such as Linear Polarization or Generalized Corrosion can also be studied.



Fig. 91: Test Box-3

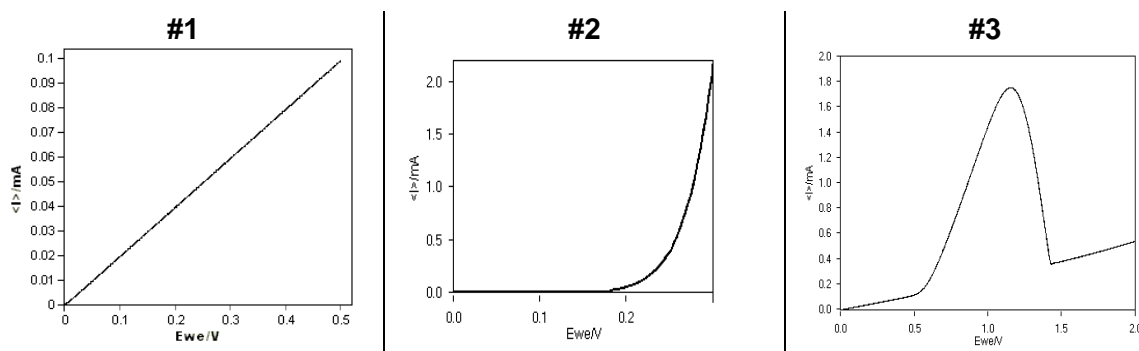

Fig. 92: stationary curve obtained with Test Box-3.

## 8.2 Temperature probe

To allow the user, to follow the temperature, temperature probe (PN: 092-22/13) is connected to the auxiliary input and output of the potentiostat board. The temperature probe is fully interfaced in EC-Lab<sup>®</sup> software.

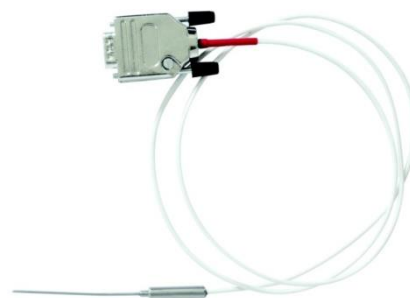

Fig. 93: Temperature probe.

## 8.3 Battery holders

### 8.3.1 Battery Holder: BH-1

This accessory is especially dedicated to make battery testing easier. This holder is modular and it is compatible with a wide variety of battery types (coin cells, 18650 and 26650 cells). The BH-1 can accommodate up to 4 batteries in pairs of two. Perfect contact of the BH-1 connectors with the battery poles is ensured by spring-loaded connection points. Each of the batteries is secured in place by isolating separators specifically designed for each battery type.

It is possible to test many batteries simultaneously, for this it is possible to link the holders in series.



Fig. 94: Battery holder, BH-1.

### 8.3.2 Battery Holder: BH-2

Another battery holder is offered. There are eight positions and all the batteries have to have the same length. A maximum of 15 A can go through the connector.



Fig. 95: Battery holder, BH-2.

### 8.3.3 Coin Cell Holder: CCH-1

This coin cell holder replaces the cables. It allows user to test four coin cells in parallel. Four CCH-1 can be connected to the VMP3.



Fig. 96: Coin Cell Holder, CCH-1.

## 8.4 Rack

To get a compact setup, it is possible to put five units in a rack with lateral tablet for computer. It is possible to use this rack for VMP3, Booster chassis, HCP and CLB only if the sliding option is not purchased.

Rack specifications:		
Maximum unit		5 units
	Rack	1850x600x710
Rack Dimension/mm (H x W x D)	Shelf <u>with</u> the sliding tablet	257x495x450
	Shelf <u>without</u> the sliding tablet	295x495x450
Temperature Range/°C		10 – 40



Fig. 97: Rack with five units.



## 8.5 Sensor Adapter Module

The Sensor Adapter Module (SAM-50) is necessary to perform measurements up to 50 V on each channel, which is an interesting feature to test stacks of energy devices (fuel cells, photovoltaic cells). This accessory needs to be connected to the VMP3 channels. It enlarges the voltage range to 50 V on each channel. Actually, SAM-50 is a level shifter. It is able to measure a difference of potential include in the normal range of a channel board which is [-10; +10] V. One channel is able to measure 2 cells of one stack, so with a SAM-50 connected to 5 channels, the user can measure 10 cells.

With this accessory, each element of the stack can be tested simultaneously while the master channel control the whole stack. The master channel can be connected to not to any booster of our range.



Fig. 98: SAM-50

### SAM50 specifications:

<b>Input voltage</b>	0 – 50 V
<b>Output voltage</b>	$\pm 10$ V
<b>Common rejection mode</b>	70 dB
<b>Accuracy (Full Scale Range)</b>	0.3 %
<b>Bandwith</b>	220 kHz
<b>Slew Rate</b>	2 V/ $\mu$ s
<b>Rise/Fall Time</b>	1 $\mu$ s
<b>Input impedance</b>	400 k $\Omega$

## 8.6 The Bipot cable and N-Stat boxes

The Bipot cable or N-Stat box are an accessories designed for multielectrode cell applications. Working with multielectrode cells generally implies a muddled connection. So far, the instrument to multielectrode cells connections can be done with the standard cables. The main advantage of the N'Stat box is a much-simplified INSTRUMENT to cell connection. The N'Stat box also improves accuracy for low currents and high impedance measurements by providing reference electrode buffering and active shielding for the working electrode leads (see paragraph 2).

The N-Stat box has up to 4 or 8 cables on one side depending on the model (Two N-Stat box models are available: One with 4 channels and one with 8 channels). Those cables connect in place of the instrument cell cables. On the other side, there is a DB25 connector to which a cell cord with individual cables is attached. This cord is made with 4 working electrodes leads (red), one reference electrode lead (white), and two counter electrode leads (black) connected to the ground.

## 8.7 Labview VIs

The potentiostat can be controlled with the free EC-Lab<sup>®</sup> development package. This package is devoted to software developers who need to integrate the control of the Bio-Logic potentiostats/galvanostats/EIS with OEM software. The EC-Lab<sup>®</sup> development package includes also a LLB LabVIEW<sup>®</sup> library where the functions of the DLL are implemented (Requirements: LabVIEW<sup>®</sup> V8.5 or higher). This development package includes a DLL with specific functions for:

- connection/disconnection to a selected instrument (Ethernet or USB),

- initialization of the channels by loading the firmware,
- loading protocols on the channels:
  - all techniques available in EC-Lab<sup>®</sup> Express
- starting/stopping the selected channel(s),
- retrieving data.
- Note that the time base with these LabVIEW<sup>®</sup> Vis depends on the considered protocol.

## 8.8 Electrochemistry accessories

Bio-Logic can provide accessories for various fields of electrochemistry.  
Please consult the Bio-Logic website for more details:

<http://www.bio-logic.info/electrochemistry-ec-lab/accessories/>

## 9 Calibration and Maintenance

### 9.1 New boards installation in an existing instrument

When a user orders new boards (channel board or low current board), he can install them himself. The procedure for this operation is described in the corresponding service note. With the provided boards, the latest software version is always installed. The procedure consists in 4 steps:

- 1- Install the new software version on the computer and on the instrument firmware in order to have the old unit and the new boards in the same software version.
- 2- Power off the unit.
- 3- Install the new boards in the chassis and power on the unit.
- 4- Calibrate the new boards (with EC-Lab<sup>®</sup>) in the unit.

The low current boards are coupled with a channel board, so a low current board must **ALWAYS** be calibrated with the corresponding channel board.

### 9.2 Software channel calibration

**CAUTION !!!: Before operating remove all cell cables from the channel boards.**

- 1) In the EC-Lab<sup>®</sup> software, select "**Tools/channels calibration**" and follow the instructions. You will receive the following message:

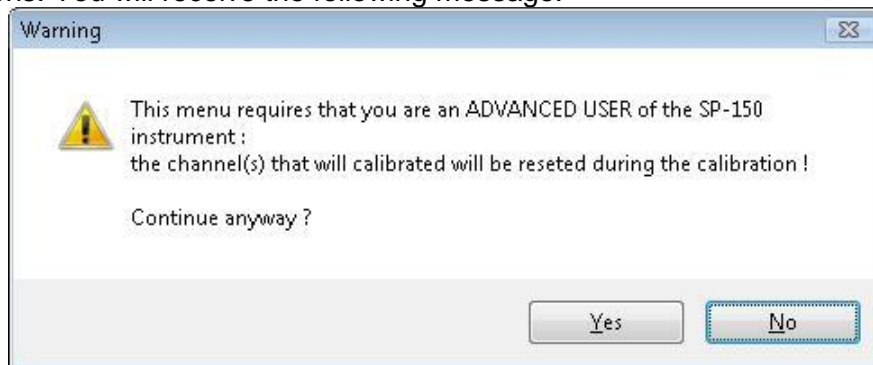

Answer "**Yes**" to the warning message. Then the board calibration window appears.

- 2) Select a channel (in our example channel 1 and 3) and click on the calibrate button.

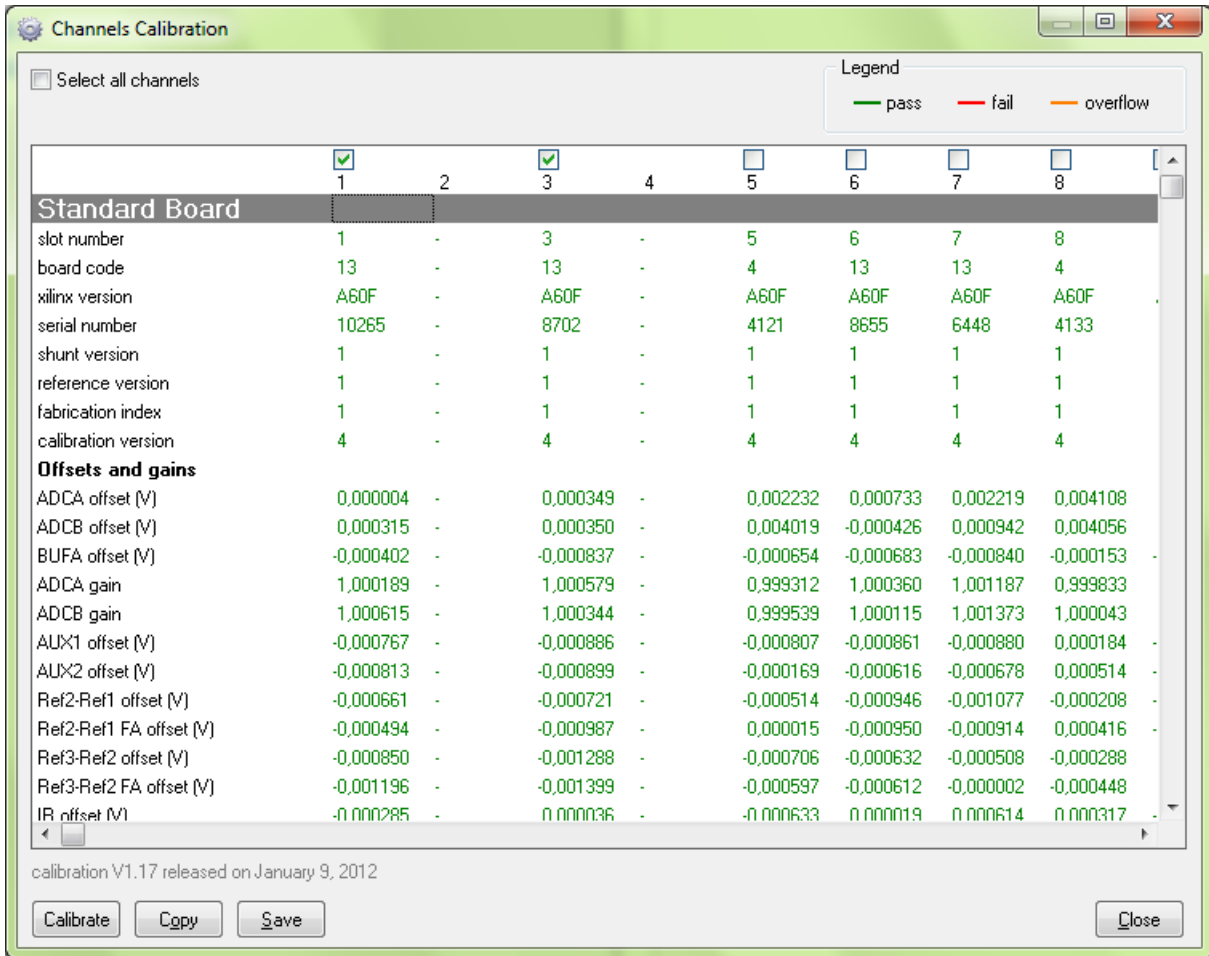

3) Click on Ok.

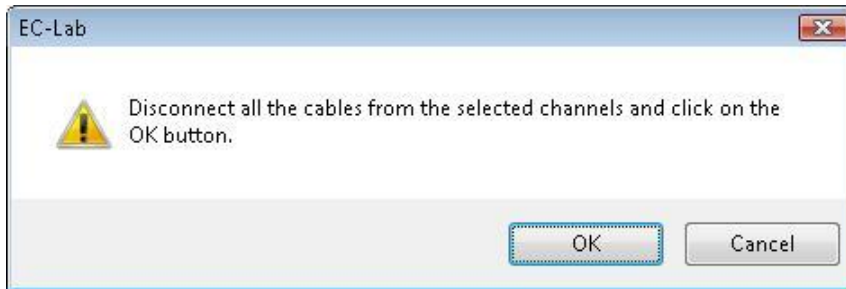

4) Disconnect all the cables from the channels to be calibrated as called for in the message, including the DB25-DB25 ribbon cable.



Then the calibration of the channel board will begin. For each variable, the numerical value corresponds to the compensated offset or gain and “pass” signifies that the calibration is made. If “failed” appears instead of “pass” then the calibration cannot be done. The channel board is probably damaged and must be sent back to the factory to be repaired.

When this calibration is finished, click on copy and paste the results in Word. Then save the file and print the report.

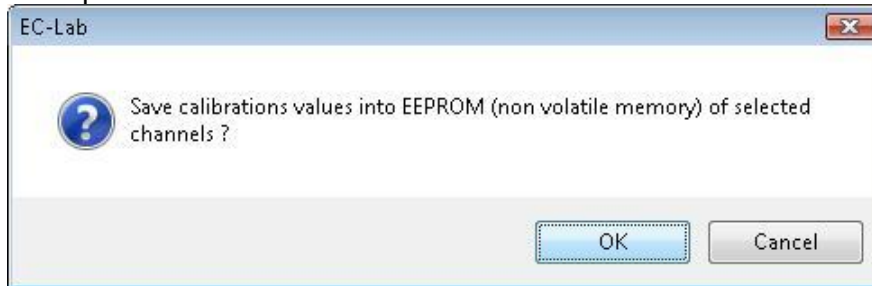

5) Click on “Ok” to save the calibration parameters on the channel board. On the board calibration window the message “calibration saved on channel X” appears.

If a "p" low current board is connected to the channel, the user must calibrate the low current board as follows.

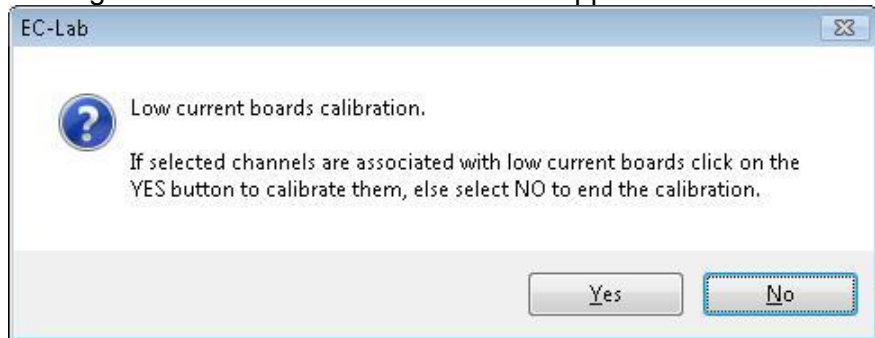

6) Click on “Yes” to calibrate the low current board. The connection message between the standard and the low current board appears:

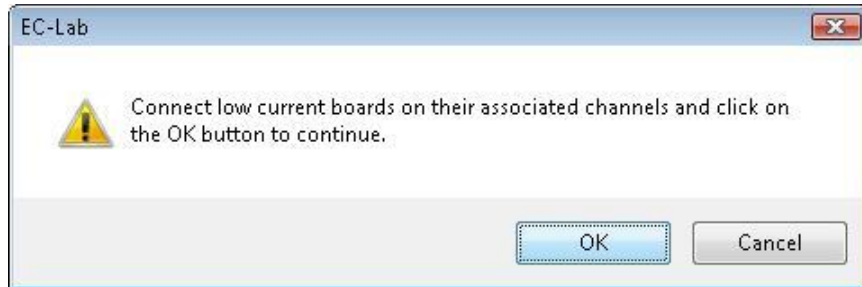

7) Click on "Ok" to start the low current board calibration.

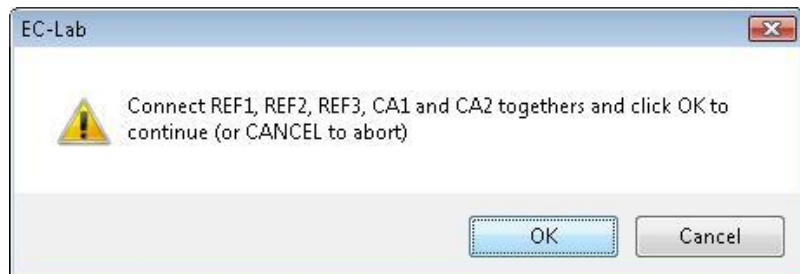

8) Connect all the banana terminal plugs of the low current board together to the same potential point and click on "Ok" to start the low current board calibration.



9) Disconnect Ref3 and CE/CA1 from the other cables and connect them together. Click "Ok"

10) A last message will ask you to save calibration values in the low current board memory. Now the standard channel board is calibrated and the calibration parameters have been saved in the channel board memory. If a low current board is connected to this channel board, it has been calibrated too. Then **close** the calibration window. The standard program will reload on the channel board.

### 9.3 Equipment maintenance

**WARNING !:** Before performing any maintenance, disconnect the power cord and all test cables.

Our instruments do not require a specific maintenance. Each channel board is calibrated at the factory before to be delivered to the customer. According to the temperature differences between winter and summer, we recommend to adjust the gains and offsets of the channel boards twice a year especially if the instrument is not in an air-conditioned room. This adjustment is performed using EC-Lab<sup>®</sup> software channel calibration in the "Tool" menu. We also recommend a full check-up of the instrument (at the factory) every two years.

**Ventilation:**

The user must carefully check that the ventilation grids are not obstructed under the chassis. An external cleaning can be made with a vacuum cleaner if necessary.

**Cleaning:**

Ventilation grids: external cleaning can be made with a vacuum cleaner if necessary.

Use a damp cloth or mild, water-based cleaner to clean the instrument. *Clean* the exterior of the box only, never the circuit board. *Do not apply cleaner directly to the box or allow liquids to enter or spill* on the box.

**Fuses:**

**WARNING !:** To maintain protection from electric shock and fire, replace fuses, with the same rating and type.

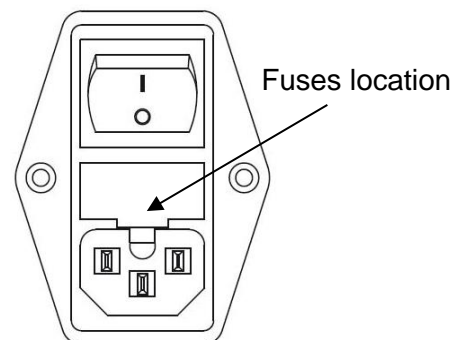

## 10 Technical Specifications

### 10.1 Equipment Ratings

#### 10.1.1 Electrical & Mechanical specifications

Instrument type	Input				Output		Mechanical	
	Voltage Range/Vac	Frequency range/Hz	Power max/W	Fuses <sup>a</sup>	Voltage range/Vdc	Current	Size (HxWxD)/mm	Weight without cable/kg
SP-50	[90;264]	[50; 60]	65	2 x 2 AF	± 10	800 mA	197x136x377	4.5
SP-150	[90;264]	[50; 60]	65	2 x 2 AF	± 10	800 mA or 240 mA with LC option	197x136x377	4.5
EPP-4000	[90;264]	[50; 60]	300	2 x 5 AF	± 10	400 mA or 4 A with 4 A option	95x435x335	8
VSP	[90;264]	[50; 60]	300	2 x 5 AF	± 10	400 mA or 4 A with 4 A option or 240 mA with LC option	95x435x335	8
VMP3	[90;264]	[50; 60]	650	2 x 6.3 AF	± 10	400 mA or 4 A with 4 A option or 8 A with 8 A option or 240 mA with LC option	262x495x465	20
HCP-803	[90;264]	[50; 60]	1 000	2 x 10 AF	±3	80 A <sup>b</sup>	262x495x465	22.3
HCP-1005	[90;264]	[50; 60]	1 000	2 x 16 AF	±5	100 A <sup>c</sup>	262x495x465	25
CLB-500	[90;264]	[50; 60]	200	2 x 4 AF	10	50 A or 5 A <sup>d</sup> (2 ranges)	262x495x465	19
CLB-2000	[90;264]	[50; 60]	100	2 x 4 AF	50	150 A <sup>d</sup>	262x495x465	28
External Booster	[90;264]	[50; 60]	1 000	2 x 10 AF	± 10	2 A with 2 A booster 5 A with 5 A booster 10 A with 10 A booster 20 A with 20 A booster	284x495x465	24 (chassis) 1 for 2A & 5A 2 for 10 A 4 for 20 A

a: cold start-250 VAC (5x20 mm) (Neutral+phase)

b: Maximum loading dissipation: 500 W. Protection: current overload (current limiting) and overheat at 70°C (auto-recovery)

c: Maximum loading: 1000 W. Protection: current overload (current limiting) and overheat at 70°C (auto-recovery)

d: Maximum loading dissipation: 500 W/2000 W. Protection: current overload (current limiting) and overheat at 100°C (auto-recovery)

#### 10.1.2 Environmental

- **Indoor use**
- **Operating Temperature:** 10°C to +40°C Indoor use
- **Storage Temperature:** 0°C to +50°C
- **Pollution degree:** 1 (no pollution or only dry)
- **Altitude:** <2000 m above sea level
- **Humidity:** 10% to 80% non-condensing
- **Case protection:** IP20 or better
- **Warm-up:** 1 hour to rated accuracy
- **Cooling:** Internal DC Fans
- **Vibration:** not specified
- **Choke:** not specified

**Safety** complies with EN61010-1.

**EMC** complies with EN61326.

## 10.2 Specifications

### 10.2.1 Channel board

Cell control	
Connection	2, 3, 4 or 5 terminal leads (+ ground)
Converters	16 bits dynamic DAC 12 bits attenuation DAC - 12 bits DC shifts DACs
Compliance	20 V range adjustable from $\pm 10$ V to 0 – 20 V
Maximum current	$\pm 400$ mA continuous
Maximum potential resolution	300 $\mu$ V on 20 V dynamic range programmable down to 5 $\mu$ V on 120 mV dynamic range <i>For example:</i> For an E range of [0;20]V, the resolution is 305 $\mu$ V. For [0;19.64]V, the resolution is 300 $\mu$ V. For [0;13.09]V, the resolution is 200 $\mu$ V. For [0; 6.53]V, the resolution is 100 $\mu$ V. For [0; 3.26]V, the resolution is 50 $\mu$ V. For [0; 1.29]V, the resolution is 20 $\mu$ V. For [0; 0.64]V, the resolution is 10 $\mu$ V. For [0; 0.31]V, the resolution is 5 $\mu$ V.
Maximum current resolution	0.004 % of the dynamic range programmable down to 760 pA on the 10 $\mu$ A range
Accuracy (DC)	< 0.1 % FSR*
Rise Time	< 2 $\mu$ s (no load)
Acquisition time	20 $\mu$ s
Current measurement	
Ranges	$\pm 10$ $\mu$ A to $\pm 400$ mA (7 ranges)
Maximum resolution	0.004 % FSR*
Acquisition speed	200,000 samples/s
Accuracy (DC)	< 0.1 % FSR*
Potential measurement	
Converters	16 bits ADC + 12 bits DC shift DAC's
Ranges	$\pm 10$ V adjustable ( $\pm 2.5$ V, $\pm 5$ V, $\pm 10$ V)
Maximum resolution	0.0015 % of the range, down to 75 $\mu$ V
Acquisition speed	200,000 samples/s
Accuracy (DC)	< 0.1 % FSR*
Electrometer	
Inputs	3 potential measurements
Impedance	> $10^{12}$ ohms in parallel with < 20 pF
Bias current	< 5 pA
Common mode rejection	> 60 dB at 50kHz
Auxiliary Inputs / Outputs	
2 analog inputs	16 bits resolution with automatic $\pm 2.5$ V, $\pm 5$ V, $\pm 10$ V ranges
1 analog output	$\pm 10$ V
1 input trigger	TTL level
1 output trigger	TTL level
1 security input to Open Circuit	TTL level
Impedance specifications (Z version only)	
Frequency range	10 $\mu$ Hz to 1 MHz (see contour plot)
Amplitude	programmable from 1 mV to 1 V peak to peak (potentio mode) 0.1 % to 50 % of the current range (galvano mode)
Accuracy	< 1 %, 1°



**Contour plot**

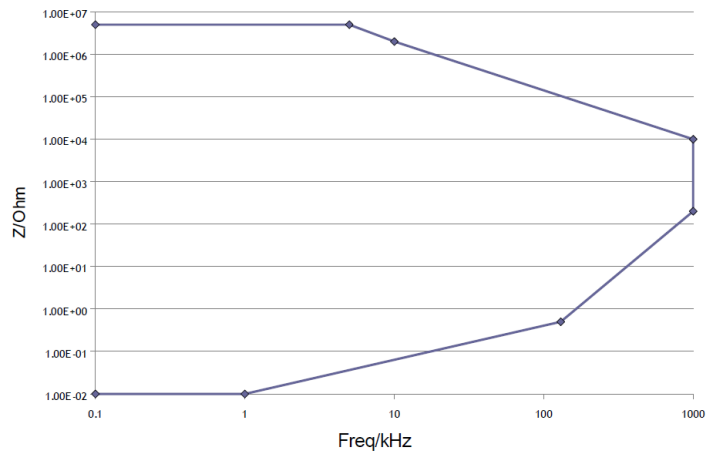

\*FSR: Full Scale Range  
 Specifications subject to change.

**10.2.2 Low Current (LC) option**

**Cell control**

<b>Maximum current</b>	± 100 mA continuous
<b>Maximum current resolution</b>	0.004 % of the dynamic range programmable 76 fA on the 1 nA range
<b>Applied current resolution</b>	< 1 % FSR* on the 1 nA range < 0.5 % FSR* on the 10 nA range < 0.1 % FSR* on the other ranges

**Current measurement**

<b>Ranges</b>	± 1 nA, ± 10 nA, ± 100 nA, ± 1 µA
<b>Maximum resolution</b>	0.004 % FSR*
<b>Accuracy</b>	< 1 % FSR* on the 1 nA range < 0.5 % FSR* on the 10 nA range < 0.1 % FSR* on the other ranges

**Electrometer**

<b>Impedance</b>	10 <sup>14</sup> ohms in parallel with 1 pF
<b>Bias current</b>	60 fA typical, 150 fA max at 25°C
<b>Bandwith</b>	1 MHz

**Impedance specifications (if connected to channel board with EIS ability)**

**Contour plot**

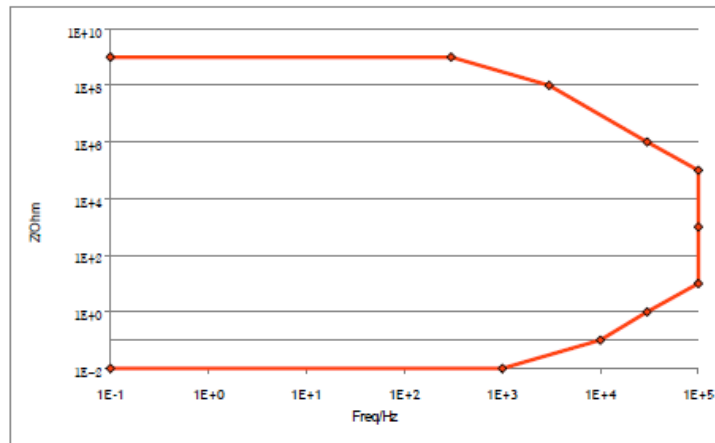

## 10.2.3 4 A/8 A internal boosters

Cell control		4 A	8 A (discontinued)
Maximum current		± 4 A continuous	± 8 A continuous
Potential ranges		± 10 V at 4 A	± 10 V at 8 A
Rise and fall time 10 % to 90 %		Potential mode: 15 µs Galvano mode: 100 µs	Potential mode: 20 µs Galvano mode: 100 µs
Maximal Continuous Dissipated Power		50 W No limit for VSP with serial number higher than #1 000 The dissipated power is calculated with the formula: (15 V-V <sub>cell</sub> ) x I <sub>charge</sub> or (V <sub>cell</sub> + 15 V) x I <sub>discharge</sub>	100 W
Measurement		4 A	8 A
Potential accuracy (DC)	< 0.1 % FSR*		< 0.1 % FSR*
Current accuracy (DC)	< 0.2 % FSR*		< 0.2 % FSR*
Current noise		1 mA peak to peak (0-100 Hz) at 4 A	1 mA peak to peak (0-100 Hz) at 8 A
Potential noise		0.6 mV peak to peak (0-100 kHz)	0.6 mV peak to peak (0-100 kHz)
Electrometer		4 A	8 A
Impedance		10 <sup>10</sup> ohms	10 <sup>10</sup> ohms
Inputs		3 potentials leads with 2 differential voltages	
Bandwidth		1 MHz	1 MHz

## 10.2.4 2 A/5 A/10 A/20 A boosters to be inserted in the booster chassis

Cell control		2/5 A	10/20 A
Connection		2, 3, 4 or 5 terminal leads (+ ground)	
Compliance		10 V range adjustable from ± 10 V to 0 – 20 V	
Maximum current		± 2 A/ ± 5 A continuous	± 10 A/ ± 20 A continuous
Maximum potential		± 20 V	
Rise Time and fall time			
- Potentio		15 µs	25 µs/60 s
- Galvano		40 µs	50 µs/120 µs
Measurement			
Potential accuracy	< 0.1% FSR*		
Current accuracy	< 0.1% FSR*		
Potential noise (peak to peak 0-100 kHz)	0.6 mV		
Potential noise (peak to peak 0-100 kHz)	1 mA at 2 A/5 A		1 mA at 10 A/20 A
Electrometer			
Inputs		3 potential measurements	
Impedance		10 <sup>10</sup> Ω	
Bandwidth		1 MHz	
Auxiliary Inputs / Outputs			
1 external input		TTL level	
Impedance specifications (if connected to channel board with EIS ability)			
Frequency range (accuracy 1%/1°)		10 µHz to 150 kHz/125 kHz (see booster contour plot)	10 µHz to 80 kHz/30 kHz (see booster contour plot)
Amplitude		1 mV to 1 V peak to peak (potentio mode) 0.1 % to 50 % of the current range (galvano mode)	

10.2.5 80 A/ 100 A boosters

Cell control	80 A	100 A
<b>Connection</b>	2, 3, 4 or 5 terminal leads	2, 3, 4 or 5 terminal leads
<b>Compliance</b>	6 V	6 V (see operating area below)
<b>Maximum current</b>	± 80 A continuous, limiting circuitry and thermal shutdown protection	± 100 A continuous, limiting circuitry and thermal shutdown protection
<b>Voltage Range</b>	± 5 V at 1 A and ± 3 V at 80 A	0.6 - 5 V range adjustable
<b>Potential Accuracy (DC)</b>	< 1 % FSR*	
<b>Current Accuracy (DC)</b>	< 0.5 % FSR*	
<b>Current Noise</b>	14 mArms (0 – 100 kHz)	
<b>Potential Noise</b>	0.18 mVrms (0 – 100 kHz)	
<b>Rise Time</b>	0 to 80 A, 10% to 90%, no overshoot, load 10 mOhm, connections length 50 cm, potentio mode: 95 µs galvano mode: 150 µs	Galvano mode (10/100 A) 20 mΩ load (bw 3) 4 ms Galvano mode (0.5/5 V) No load (bw 3) 1.7 ms
<b>Measurement</b>		
<b>Potential Accuracy (DC)</b>	< 1 % FSR*	
<b>Current Accuracy (DC)</b>	< 0.5 % FSR*	0.5 % FSR*
<b>Current Noise</b>	14 mArms (0 – 100 kHz)	5 mA rms
<b>Potential Noise</b>	0.18 mVrms (0 – 100 kHz)	0.15 mV rms
<b>Impedance</b>		
<b>Frequency Range</b>	10 µHz to 10 kHz	10 µHz to 10 kHz (see contour plot below)
<b>Auxiliary Inputs / Outputs</b>		
<b>Temperature probe</b>	PT-100 – 0 to 250°C	
<b>1 Open In</b>	0 – 5 V TTL level	
<b>Overheat shutdown</b>	70°C	
<b>Operating area</b>		

80 A

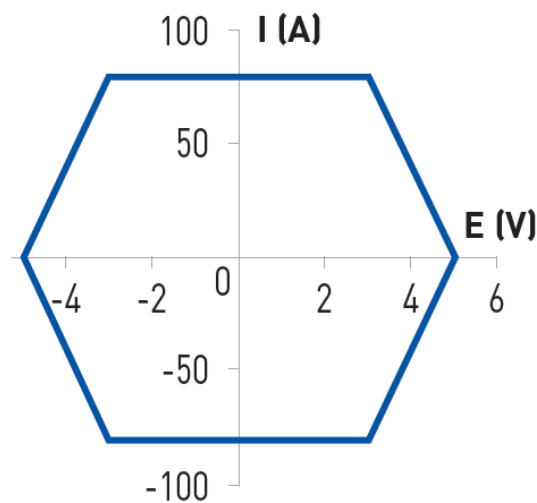

100 A

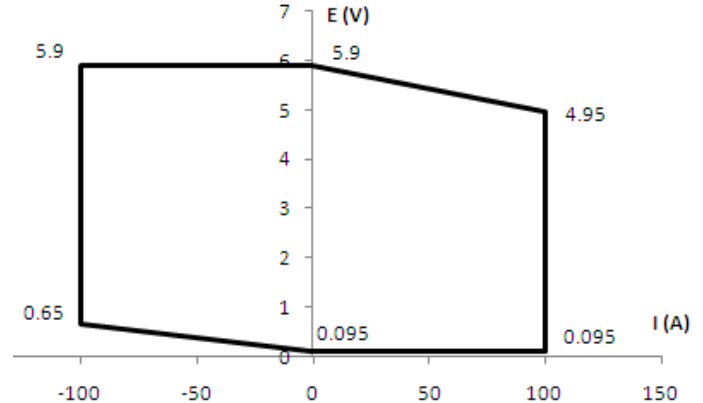

Contour plots of the boosters (2A to 100 A)

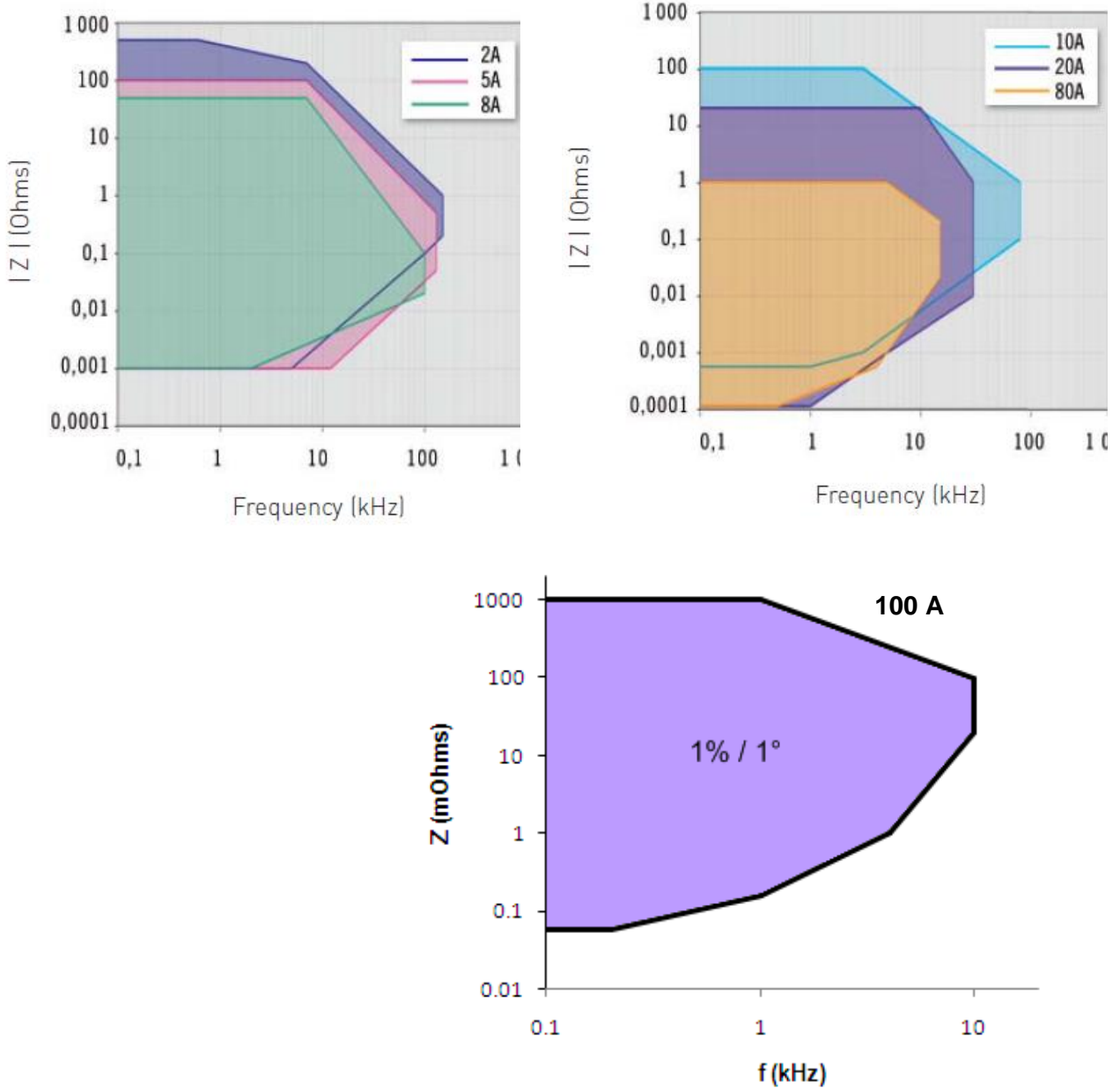

10.2.6 500 W/ 2 kW load boxes

Cell control	500 W	2 kW
<b>Connection</b>	5 terminal leads	5 terminal leads
<b>Voltage range</b>	10 V range from 0.1 V ( $I_{max}$ ) to 10 V	50 V range/10 V range. Minimum voltage: 1 V @ 150 A. (see operating area below)
<b>Max current</b>	5 A, 50 A continuous	150 A continuous
<b>Max power</b>	50 W (5 A), 500 W (50 A) @ 40°C	2 kW
<b>Rise Time:</b>	< 3 ms	< 3 ms
<b>Electrometer</b>		
<b>Inputs</b>	3 potential measurements	
<b>Impedance</b>	$10^{10} \Omega$	

**Auxiliary Inputs / Outputs**

<b>1 security input to Open Circuit</b>	TTL level	TTL level
---	-----------	-----------

<b>1 emergency stop push-button</b>	yes	yes
-------------------------------------	-----	-----

**Operating area for the 2 kW load box**

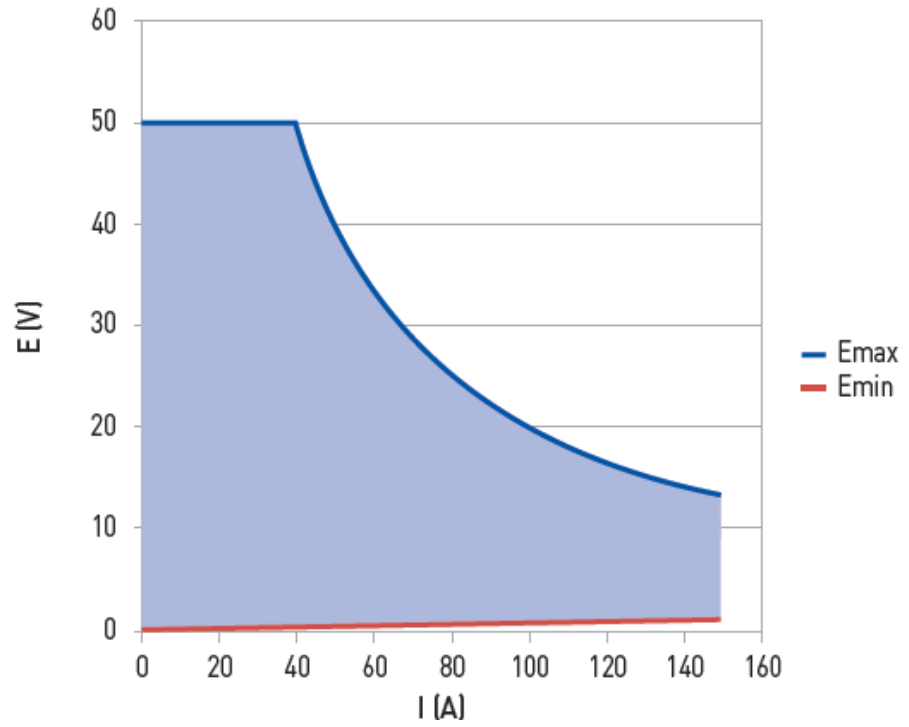

**Contour plot**

**500 W (2%;2°)**

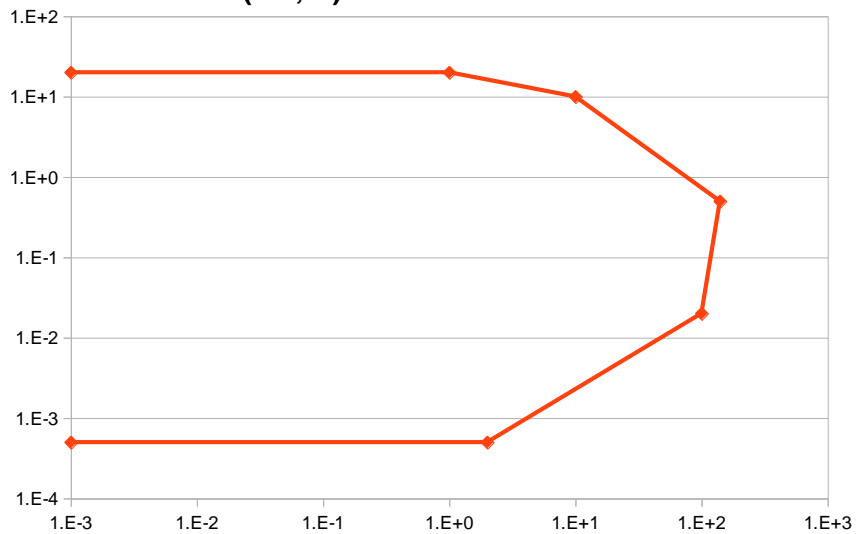

**Current measurement noise (rms/Bandwidth):**

Noise is always present since all materials produce noise at a power level proportional to the material temperature. The shunt resistor is the first noise source in a current measurement path. A resistor noise is generally referred to as thermal noise or white noise. Just as the white light contains all the colors, the white noise includes uniformly distributed power at all frequencies. Thus, total power noise is proportional to the bandwidth. To minimize noise measurement selects circuits with low noise specifications.

I range	Boost OFF
100 $\mu$ A	16 nA/100 kHz
10 $\mu$ A	1.6 nA/26 kHz
1 $\mu$ A	0.16 nA/3.5 kHz
100 nA	17 pA/520 Hz
10 nA	1.7 pA/100 Hz
1 nA	0.18 pA/28 Hz

**10.3 PC requirements**

Recommended:

- Pentium 2 GHz
- 2 Go RAM
- 80 GB Hard Drive
- Screen resolution 1280\*1024
- Ethernet board with 10/100 base T or USB port
- Windows XP<sup>®</sup> (SP2), Seven, Eight (32 or 64 bits).

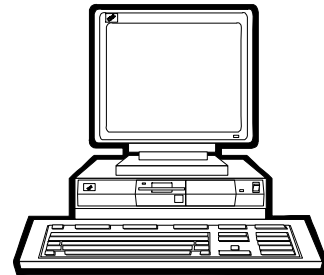

© Microsoft Corporation. All rights reserved.

**10.4 Safety precautions**

To avoid electrical shocks:

- The equipment must be connected to a protective ground.
- The equipment must be disconnected from the power source before it is opened.

To avoid electrostatic shocks:

- Every lead from the instrument to the cells (or booster to cells) must be connected either to an electrochemical cell or to the testing box.

## 11 Troubleshooting

---

### 11.1 Data saving

Problem: Data cannot be saved from a given channel (this channel appears in yellow into EC-Lab<sup>®</sup>, and the program displays an error message while attempting to save data):

Solution(s):

- ensure that the saved file has not be moved or destroyed, or opened by another application,
- if the saved file is on a network drive, ensure that you have the right to write data into the same directory (create and destroy a text file). Otherwise see your network authorizations....,
- in EC-Lab<sup>®</sup>, select **File, Repair...** Then select the saved file and click on the **Repair** button,
- ensure that the computer's IP Address has not been modified since the beginning of the experiment,
- if the problem persists, contact us.

### 11.2 PC Disconnection

Problem: The PC is disconnected from the instrument ("Disconnected" is displayed in red on the EC-Lab<sup>®</sup> status bar):

Solution(s):

- check the PC – instrument connection,
  - direct connection: verify that the Ethernet cable is plugged from both ends,
  - network connection: verify that the yellow led is blinking on the instrument front panel and that you can access to your network directories from the PC,
- check that the green led is blinking (this assumes that the multichannel potentiostat is always running properly),
- in the Tera Term Pro window type "r" or "R": this will restart the Ethernet connection program that is a part of the instrument firmware,  
WARNING: this operation is not a simple task, so proceed like this only in case of trouble.
- if the problem persists, contact us.

### 11.3 Effects of computer save options on data recording

Electrochemical experiments often have a long duration (more than 24 hours). During the experiment, the computer should always be able to record the data points. If the user has enabled the power option for his hard disk, he risks being unable to record the data points. In order to avoid that, we advise the user to remove the power save option of his computer in the settings panel.

### 11.4 Preliminary checks

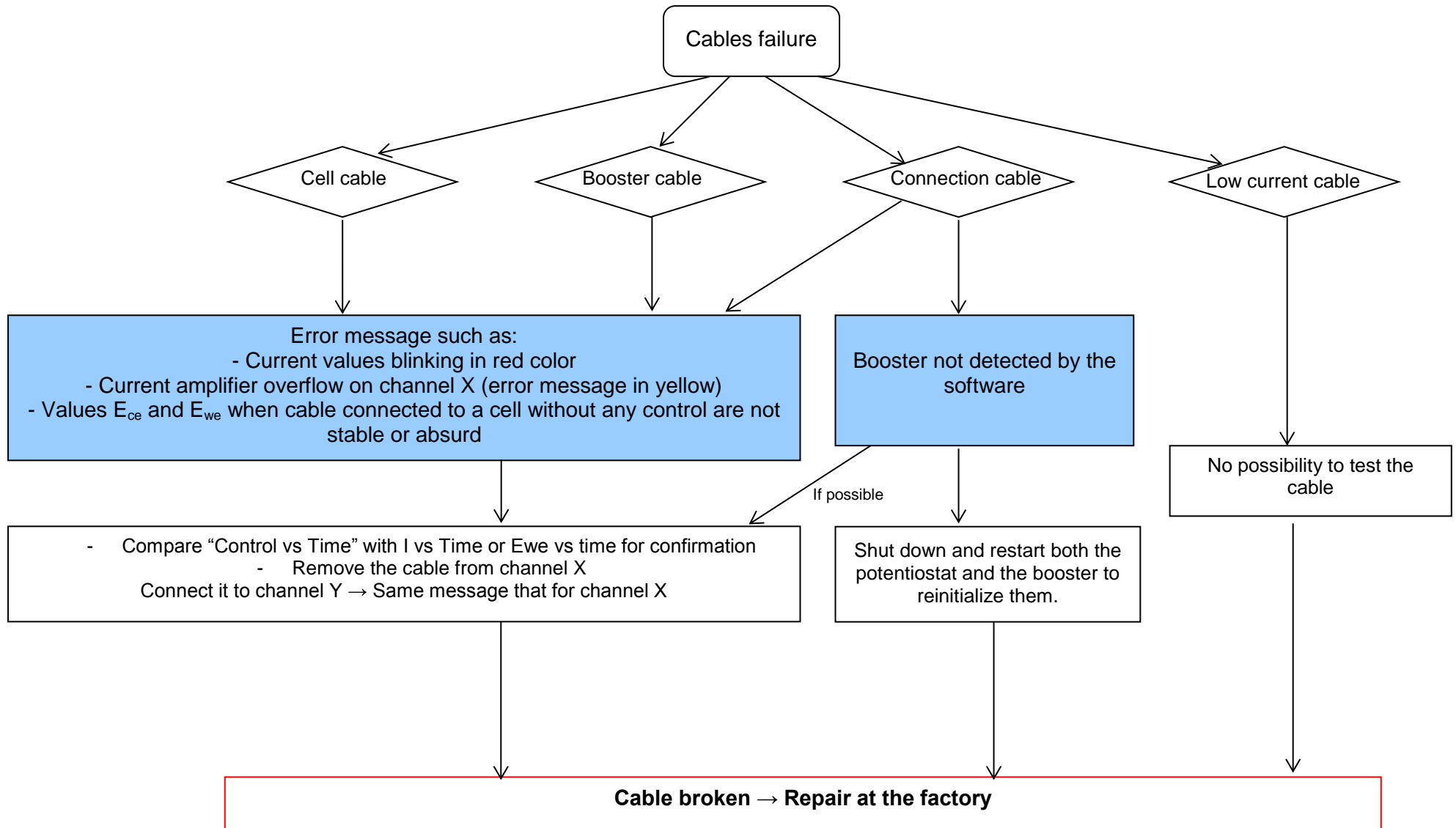



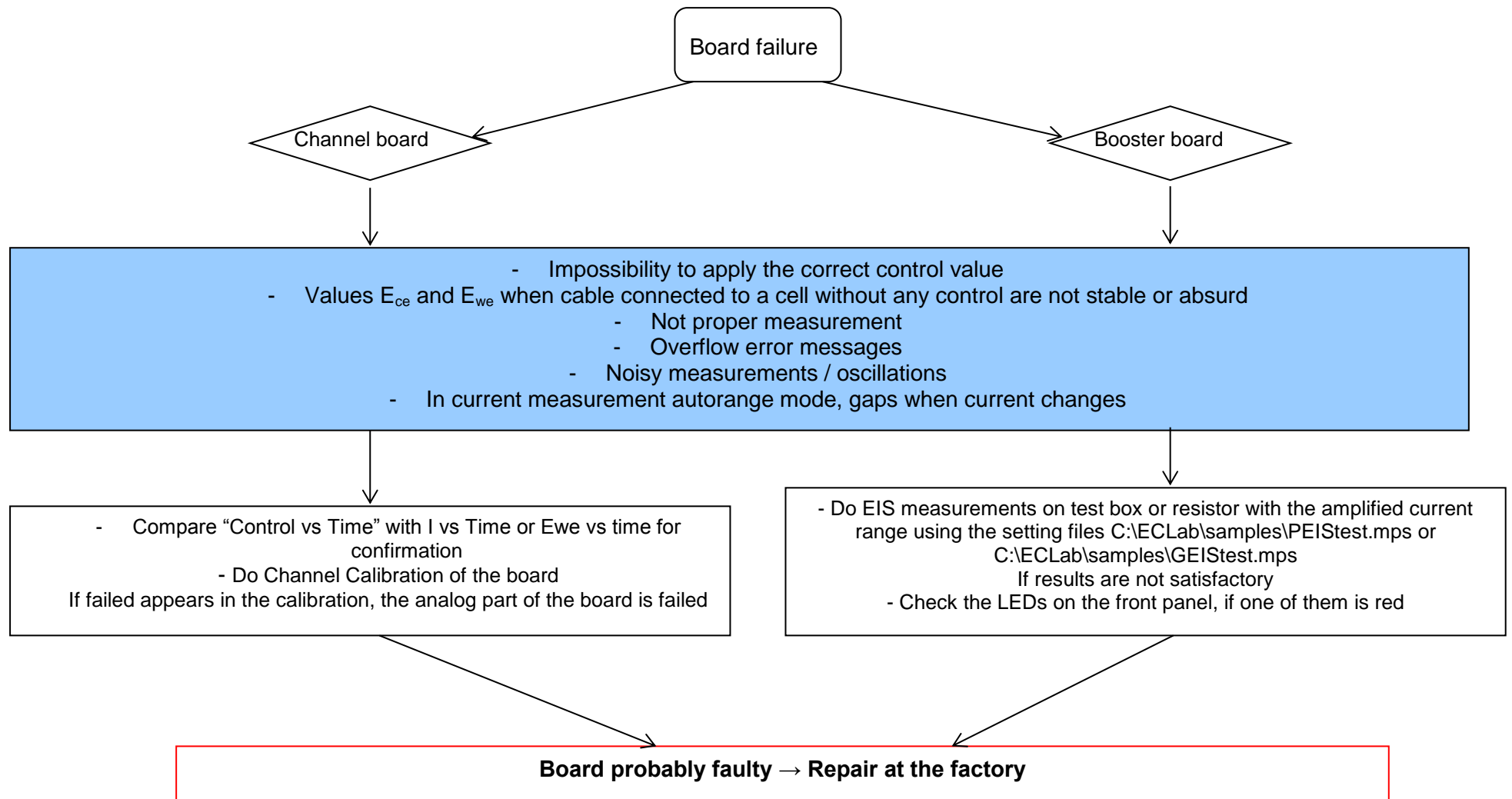

Note: if you send back a board to the factory don't forget to send cell cable associated with this board.

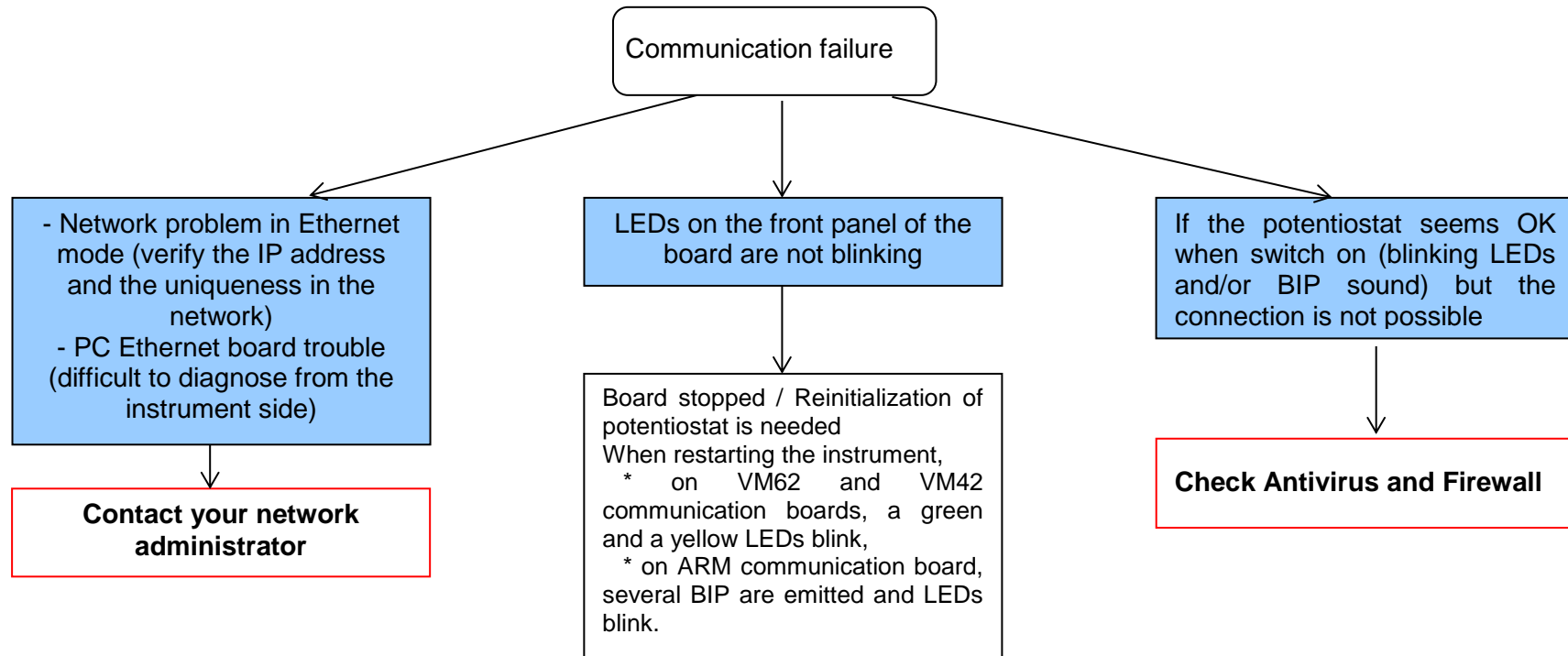

Note: Two series of communication boards are available in our instrument range:

- VM42 and VM62 communication boards (without USB connection) for the VMP1, MPG, VMP2 and first generation of BiStat
- ARM communication board (Ethernet and USB connection) for the VMP3, VSP, HCP-803, EPP series, SP150, SP-50, VSP and last generation of BiStat.

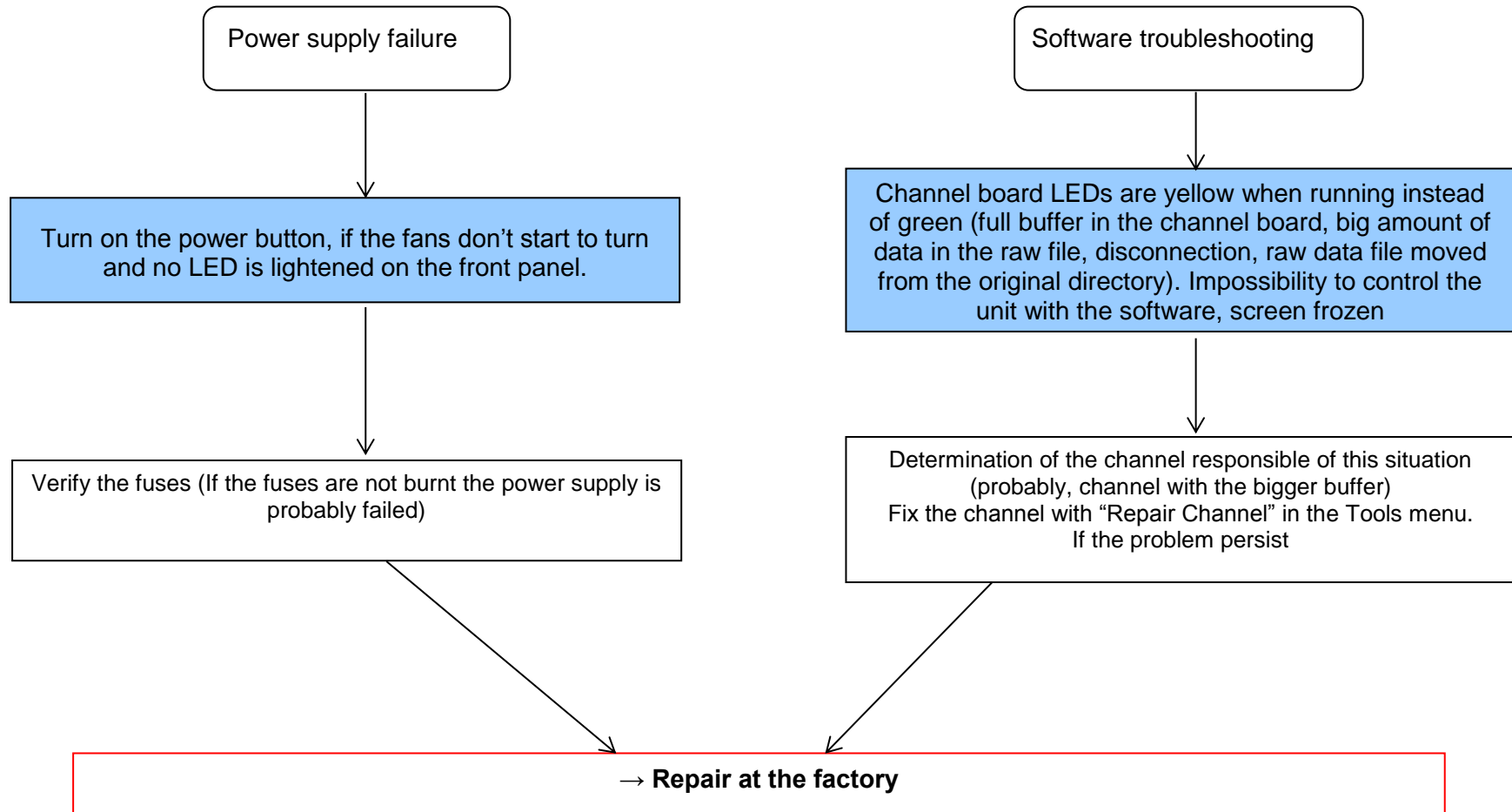



## 12 EC declaration of conformity

### 12.1 SP-50/SP-150

 **BioLogic**  
Science Instruments

Bio-Logic SAS  
1 rue de l'Europe  
F-38640 Claix  
France

Tel.: +33 476 986 831  
Fax: +33 476 986 909  
Web : www.bio-logic.info

SAS capital 337 000 €  
SIRET 328 685 284 000 31  
APE 2651B

---

# CE

## DECLARATION OF CONFORMITY

N°: CETR\_SP-150 Rev. C

We,  
**Bio-Logic SAS**  
**1, Rue de l'Europe**  
**38840 Claix France**

declare under our sole responsibility that the products,  
**SP-50 with cables**  
**SP-150 with cables**  
**SP-150 with Low Current option and cables**

are in conformity with the following standard(s) in accordance with the provisions of the  
Electromagnetic Compatibility Directive 2004/108/CE and the Low Voltage Directive 2006/95/CE.

Security: IEC 61010-1  
EMC: IEC 61326

Emissions  
EN 55022: Conducted Class B  
EN 55022: Radiated Class B  
EN 61000-3-2: Harmonic Current

Immunity  
IEC 61000-4-2: ESD  
IEC 61000-4-3: EM field  
IEC 61000-4-4: Burst  
IEC 61000-4-5: Surge  
IEC 61000-4-6: Conducted RF  
IEC 61000-4-8: Magnetic Field  
IEC 61000-4-11: Voltage Dip/Short Interruptions

Date: August 20, 2012

  
\_\_\_\_\_  
J-P Ourdouillie, Compliance Manager

  
\_\_\_\_\_  
François Goy, President

## 12.2 VSP/Bistat/EPP-4000



**BioLogic**  
Science Instruments

**Bio-Logic SAS**  
1, rue de l'Europe  
F-38640 Claix  
France

Tel: +33 476 98 68 31  
Fax: +33 476 98 69 09  
Web: www.bio-logic.info

SAS capital 337 000 €  
SIRET 328 685 284 000 31  
APE 2651B

### EC DECLARATION OF CONFORMITY

N°: CETR\_VSP\_Rev. B

We,

**Bio-Logic SAS**  
**1, Rue de l'Europe**  
**38840 Claix France**

declare under our sole responsibility that the products,

**VSP with cables**  
**VSP with 4A option & cables**  
**Bistat with cables**  
**EPP-4000 with cables**

are in conformity with the following standard(s) in accordance with the provisions of the Electromagnetic Compatibility Directive 2004/108/CE and the Low Voltage Directive 2006/95/CE.

Security: IEC 61010-1  
EMC: IEC 61326

#### Emissions

EN 55022: Conducted Class B  
EN 55022: Radiated Class A  
EN 61000-3-2: Harmonic Current

#### Immunity

IEC 61000-4-2: ESD  
IEC 61000-4-3: EM field  
IEC 61000-4-4: Burst  
IEC 61000-4-5: Surge  
IEC 61000-4-6: Conducted RF  
IEC 61000-4-8: Magnetic Field  
IEC 61000-4-11: Voltage Dip/Short Interruptions

Date: February 19, 2010

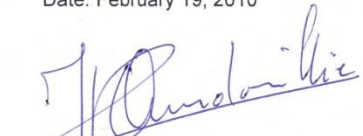
  
\_\_\_\_\_  
J-P Ourdouillie, Compliance Manager

  
\_\_\_\_\_  
François Goy, President

## 12.3 VMP3



**BioLogic**  
Science Instruments

**Bio-Logic SAS**  
1, rue de l'Europe  
F-38640 Claix  
France

Tel: +33 476 98 68 31  
Fax: +33 476 98 69 09  
Web: www.bio-logic.info

SAS capital 337 000 €  
SIRET 328 685 284 000 31  
APE 2651B

### EC DECLARATION OF CONFORMITY

N°: CETR\_VMP3\_Rev. B

We,

**Bio-Logic SAS**  
**1, Rue de l'Europe**  
**38840 Claix France**

declare under our sole responsibility that the products,

**VMP3 with Potentiostats & cables**

**VMP3 with 4A Booster Kit option & cables**

**VMP3 with 8A Booster Kit option & cables**

are in conformity with the following standard(s) in accordance with the provisions of the Electromagnetic Compatibility Directive 2004/108/CE and the Low Voltage Directive 2006/95/CE.

Security: IEC 61010-1

EMC: IEC 61326

#### Emissions

EN 55022: Conducted Class B

EN 55022: Radiated Class A

EN 61000-3-2: Harmonic Current

#### Immunity

IEC 61000-4-2: ESD

IEC 61000-4-3: EM field

IEC 61000-4-4: Burst

IEC 61000-4-5: Surge

IEC 61000-4-6: Conducted RF

IEC 61000-4-8: Magnetic Field

IEC 61000-4-11: Voltage Dip/Short Interruptions

Date: February 26, 2010

J-P Ourdouillie, Compliance Manager

François Goy, President

## 12.4 External Booster



**BioLogic**  
Science Instruments

**Bio-Logic SAS**  
1, rue de l'Europe  
F-38640 Claix  
France

Tel: +33 476 98 68 31  
Fax: +33 476 98 69 09  
Web: www.bio-logic.info

SAS capital 337 000 €  
SIRET 328 685 284 000 31  
APE 2651B

### EC DECLARATION OF CONFORMITY

N°: CETR\_VMP3-BOOSTER\_Rev. B

We,

**Bio-Logic SAS**  
**1, Rue de l'Europe**  
**38840 Claix France**

declare under our sole responsibility that the products,

**VMP3-BOOSTER with 20A & cables**

**VMP3-BOOSTER with 2x2A, 5A, 10A & cables**

are in conformity with the following standard(s) in accordance with the provisions of the Electromagnetic Compatibility Directive 2004/108/CE and the Low Voltage Directive 2006/95/CE.

Security: IEC 61010-1

EMC: IEC 61326

Emissions

EN 55022: Conducted Class B

EN 55022: Radiated Class A

EN 61000-3-2: Harmonic Current

Immunity

IEC 61000-4-2: ESD

IEC 61000-4-3: EM field

IEC 61000-4-4: Burst

IEC 61000-4-5: Surge

IEC 61000-4-6: Conducted RF

IEC 61000-4-8: Magnetic Field

IEC 61000-4-11: Voltage Dip/Short Interruptions

Date: March 9, 2010

  
\_\_\_\_\_  
J-P Ourdouillie, Compliance Manager  
\_\_\_\_\_  
François Goy, President



## 12.5HCP-803/80 A Booster



**BioLogic**  
Science Instruments

**Bio-Logic SAS**  
1, rue de l'Europe  
F-38640 Claix  
France

Tel: +33 476 98 68 31  
Fax: +33 476 98 69 09  
Web: www.bio-logic.info

SAS capital 337 000 €  
SIRET 328 685 284 000 31  
APE 2651B

### EC DECLARATION OF CONFORMITY

N°: CETR\_HCP-803\_Rev. B

We,

**Bio-Logic SAS**  
**1, Rue de l'Europe**  
**38840 Claix France**

declare under our sole responsibility that the products,

**HCP-803 with cables**  
**VMP3B-80 with cables**

are in conformity with the following standard(s) in accordance with the provisions of the Electromagnetic Compatibility Directive 2004/108/CE and the Low Voltage Directive 2006/95/CE.

Security: IEC 61010-1  
EMC: IEC 61326

#### Emissions

EN 55022: Conducted Class B  
EN 55022: Radiated Class B  
EN 61000-3-2: Harmonic Current

#### Immunity

IEC 61000-4-2: ESD  
IEC 61000-4-3: EM field  
IEC 61000-4-4: Burst  
IEC 61000-4-5: Surge  
IEC 61000-4-6: Conducted RF  
IEC 61000-4-8: Magnetic Field  
IEC 61000-4-11: Voltage Dip/Short Interruptions

Date: April 6, 2010

J-P Ourdouillie, Compliance Manager

Francois Goy, President

## 12.6 HCP-1005/100 A Booster



**BioLogic**  
Science Instruments

**Bio-Logic SAS**  
1, rue de l'Europe  
F-38840 Claix  
France

Tel: +33 476 98 68 31  
Fax: +33 476 98 69 09  
Web: www.bio-logic.info

SAS capital 337 000 €  
SIRET 328 685 284 000 31  
APE 2651B

---

# CE

## DECLARATION OF CONFORMITY

N°: CETR\_HCP-1005\_Rev. A

We,  
**Bio-Logic SAS**  
**1, Rue de l'Europe**  
**38840 Claix France**

declare under our sole responsibility that the products,  
**HCP-1005 with cables, VMP3B-1005 with cables**

are in conformity with the following standard(s) in accordance with the provisions of the  
Electromagnetic Compatibility Directive 2004/108/CE and the Low Voltage Directive 2006/95/CE

Security: IEC 61010-1  
EMC: IEC 61326

Emissions  
EN 55022: Conducted Class B  
EN 55022: Radiated Class B  
EN 61000-3-2: Harmonic Current

Immunity  
IEC 61000-4-2: ESD  
IEC 61000-4-3: EM field  
IEC 61000-4-4: Burst  
IEC 61000-4-5: Surge  
IEC 61000-4-6: Conducted RF  
IEC 61000-4-8: Magnetic Field  
IEC 61000-4-11: Voltage Dip/Short Interruptions

Date: August the 16, 2010

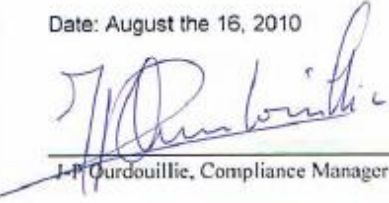

---

J-P Ourdouillie, Compliance Manager



---

François Goy, President

## 12.7 CLB-500/LB-500



**BioLogic**  
Science Instruments

**Bio-Logic SAS**  
1, rue de l'Europe  
F-38840 Claix  
France

Tel: +33 476 98 68 31  
Fax: +33 476 98 69 09  
Web: [www.bio-logic.info](http://www.bio-logic.info)

SAS capital 337 000 €  
SIRET 328 685 284 000 31  
APE 2851B

### EC DECLARATION OF CONFORMITY

N°: CETR\_CLB-500\_Rev. A

We,

**Bio-Logic SAS**  
**1, Rue de l'Europe**  
**38840 Claix France**

declare under our sole responsibility that the products,

**CLB-500 with cables**  
**LB-500 with cables**

are in conformity with the following standard(s) in accordance with the provisions of the Electromagnetic Compatibility Directive 2004/108/CE and the Low Voltage Directive 2006/95/CE.

Security: IEC 61010-1  
EMC: IEC 61326

Emissions  
EN 55022: Conducted Class B  
EN 55022: Radiated Class A

Immunity  
IEC 61000-4-2: ESD  
IEC 61000-4-3: EM field  
IEC 61000-4-4: Burst  
IEC 61000-4-5: Surge  
IEC 61000-4-6: Conducted RF  
IEC 61000-4-8: Magnetic Field  
IEC 61000-4-11: Voltage Dip/Short Interruptions

Date: April 16, 2010

  
\_\_\_\_\_  
J-P Ourbaillie, Compliance Manager

  
\_\_\_\_\_  
François Goy, President

## 12.8CLB-2000/LB-2000



**BioLogic**  
Science Instruments

---

**Bio-Logic SAS**  
1 rue de l'Europe  
F-38640 Claix  
France

Tel.: +33 476 986 831  
Fax: +33 476 986 909  
Web : www.bio-logic.info

SAS capital 337 000 €  
SIRET 328 685 284 000 31  
APE 2651B

# CE

## DECLARATION OF CONFORMITY

N°: CETR\_CLB-2000\_Rev. A

We,  
**Bio-Logic SAS**  
**1, Rue de l'Europe**  
**38840 Claix France**

declare under our sole responsibility that the products,  
**CLB-2000 with cables**  
**LB-2000 with cables**

are in conformity with the following standard(s) in accordance with the provisions of the  
Electromagnetic Compatibility Directive 2004/108/CE and the Low Voltage Directive 2006/95/CE.

Security: IEC 61010-1  
EMC: IEC 61326

Emissions  
EN 55022: Conducted Class B  
EN 55022: Radiated Class A  
EN61000-3-2: Harmonic Current Class A

Immunity  
IEC 61000-4-2: ESD  
IEC 61000-4-3: EM field  
IEC 61000-4-4: Burst  
IEC 61000-4-5: Surge  
IEC 61000-4-6: Conducted RF  
IEC 61000-4-8: Magnetic Field  
IEC 61000-4-11: Voltage Dip/Short Interruptions

Date: October 27, 2010

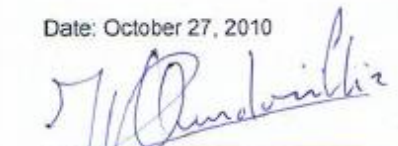
  
\_\_\_\_\_  
J-P Ourdouillie, Compliance Manager

  
\_\_\_\_\_  
François Goy, President

## 13 Glossary

---

This glossary is made to help the user understand most of the terms used in this instrument installation and configuration manual. The terms are defined in alphabetical order.

**Booster:** current power booster that can be added to each channel individually.

**Bandwidth:** represents the frequency of the regulation loop of the potentiostat. It depends on the electrochemical cell impedance. The bandwidth's values go from 1 to 7 with increasing frequency.

**Calibration:** operation that has to be done for each channel in order to reduce the difference between a controlled value (for example  $E_{ctrl}$ ) and the corresponding measured value (for example  $E_{we}$ ).

**CE to ground connection:** also called N'Stat connection, this mode allows the user to lead measurements on eight working electrodes with one or eight reference electrodes and one counter electrode connected to the ground. It is a very useful tool for biosensors study. This mode can be activated in the "Advanced settings" window.

**Cell connection:** connection of the instrument's channel board to the electrochemical cell with five leads.

**DB25:** connector with 25 pins on the instrument's front panel where the cable connecting the channel board and the electrochemical cell is set.

**DB9:** connector with 9 pins on the instrument's front panel used as auxiliary input/output.

**Default settings:** settings defined and saved as default by the user and automatically opened when the corresponding protocol is selected.

**Firmware upgrading:** the firmware is the operating system of the instrument. It is necessary to upgrade both the firmware and software to benefit from the most recent version.

**Gateway:** IP address allowing the connection of computers from different networks onto an instrument.

**Impedance:** defined by the ratio  $E/I$ .

**Low current:** option providing a sub-pA resolution that can be added to each channel. This option extends the current range down to 1 nA. This option can be added both to standard or Z option channel boards.

**Network:** group of computers connected together to which the multichannel potentiostat can be added. Several users with different computers can lead experiments on one or more channels of the potentiostat.

**N'Stat:** connection mode used to work with several working electrodes, one counter and one reference electrode in the same electrochemical cell. This mode must be used with special connections (see the user manual).

**Specifications:** Characteristics of the instrument such as cell control or current and potential measurement.

**Subnet mask:** IP number used when the instrument is not in the same network as the computer.

**TCP/IP:** Transfer Control Protocol/Internet Protocol using IP addresses to identify hosts on a network

**Triggers:** option that allows the instrument to set a trigger out (TTL signal) at experiment start/stop or to wait for an external trigger in to start or stop the run.

---

## Index

---

Bandwith .....	73, 74
Battery Holder .....	63
Booster.....	35
Channel	
Board installation .....	67
Calibration .....	67
Connection	
IP Address change .....	30
Connections	
CE to ground .....	47
cell.....	42
Instrument .....	23
Dummy cell for booster.....	61
EQCM .....	58
External device.....	58
FileRepair.....	79
Front panel.....	38
Maintenance.....	70
N'Stat .....	47
Network.....	16
N'Stat box.....	45
ProcessMass.....	58
QCM-922.....	58
Rotating electrodes .....	56
Specifications .....	72
Test Box 3.....	62
Trigger.....	50, 72
Windows® Vista.....	15

Manual Rev\_G (March 2014)

