

3116
3216

PID TEMPERATURE
CONTROLLERS

3116 and 3216 PID Temperature Controller

Contents

1.	Installation and Basic Operation.....	5
1.1	What Instrument Do I Have?	5
1.2	Unpacking Your Controller	5
1.2.1	Dimensions.....	5
1.3	Order Code	6
1.4	Step 1: Installation.....	7
1.4.1	Panel Mounting the Controller	7
1.4.2	To Remove the Controller from its Sleeve.....	7
1.5	Step 2: Wiring.....	8
1.5.1	Wire Sizes.....	8
1.5.2	Terminal Layout	8
1.5.3	PV Input (Measuring Input)	9
1.5.4	AA Output Relay	9
1.6	Input/Output 1 (Relay or Logic or DC - Optional).....	9
1.6.1	Output 2 (Relay or Logic or DC - Optional).....	9
1.6.2	Digital Communications (optional and available in 3216 only).....	10
1.6.3	Current Transformer/Logic Input (optional and available in 3216 only).....	10
1.6.4	Power Supply	11
1.6.5	Example Wiring Diagram	11
1.7	Step 3: Switch On.....	12
1.8	Initial Configuration.....	12
1.9	To Re-Enter Quick Code mode	14
1.10	Pre-Configured Controller or Subsequent Starts	14
1.10.1	Operator Interface.....	15
1.10.2	To Set The Required Temperature.....	15
1.10.3	Alarm Indication.....	15
1.10.4	Auto/Manual/Off Mode	16
1.10.5	To Select Auto/Manual and Adjust the Output Power.....	16
1.10.6	Other Commonly Used Operator Parameters Available in Level 1.....	17
1.11	Operator Level 2.....	18
1.11.1	To Enter Level 2.....	18
1.11.2	To Return to Level 1.....	18
1.12	Level 2 Parameters.....	18
2.	Access to Further Parameters.....	22
2.1.1	Level 3	22
2.1.2	Configuration Level.....	22
2.1.3	To Select Access Level 3 or Configuration Level	23
2.2	Parameter lists.....	24
2.2.1	To Choose Parameter List Headers.....	24
2.2.2	To Locate a Parameter	24
2.2.3	How Parameters are Displayed.....	25
2.2.4	To Change a Parameter Value	25
2.2.5	To Return to the HOME Display.....	25
2.2.6	Time Out.....	25
2.3	Navigation Diagram	26
2.4	Access Parameters	27
3.	Controller Block Diagram.....	29

4.	Process Input.....	30
4.1	Process Input Parameters	31
4.1.1	Input Types and Ranges.....	32
4.2	PV Offset	33
4.2.1	Example: To Apply an Offset:-.....	33
4.3	PV Input Scaling	34
4.3.1	Example: To Scale a Linear Input:-	34
5.	Input/Output.....	35
5.1	Input/Output Parameters.....	36
5.1.1	Input/Output 1 List (IO-1)	36
5.1.2	Remote Setpoint Select and Remote Fail	37
5.1.3	Sense.....	37
5.1.4	Source	37
5.1.5	Power Fail.....	37
5.1.6	Example: To Configure IO-1 Relay to Operate on Alarms 1 and 2:-.....	38
5.1.7	Output List 2 (OP-2).....	39
5.1.8	AA Relay (AA)	40
5.1.9	Logic Input Parameters.....	41
5.2	Current Transformer Input Parameters	42
5.2.1	Analogue Representation of Current Alarms	42
5.2.2	Current Transformer Wiring Diagram	43
6.	Setpoint Generator	44
6.1	Setpoint Parameters	44
6.2	Example: To Set Ramp Rate	45
7.	Control.....	46
7.1	PID Control.....	46
7.2	Tuning	47
7.2.1	Automatic Tuning.....	47
7.2.2	One-shot Tuning.....	47
7.2.3	Calculation of the cutback values.....	47
7.2.4	Manual Tuning	48
7.2.5	Setting the Cutback Values.....	48
7.3	Integral Action and Manual Reset.....	49
7.4	Relative Cool Gain	49
7.5	Control Action.....	49
7.6	On/Off Control	49
7.7	Loop Break Time.....	49
7.8	Cooling Algorithm	49
7.9	Control Parameters	50
7.9.1	Effect of Control Action, Hysteresis and Deadband	52
7.10	Example: To Configure Heating and Cooling	53
8.	Alarms	54
8.1	Types of Alarm Used in the 3200 Controller	55
8.1.1	Alarm Relay Output.....	56
8.1.2	Alarm Indication.....	56
8.1.3	To Acknowledge An Alarm.....	56
8.2	Behaviour of Alarms After a Power Cycle	57
8.2.1	Example 1	57

8.2.2	Example 2	58
8.2.3	Example 3	58
8.3	Alarm Parameters	59
8.3.1	Example: To Configure Alarm 1	60
8.4	Diagnostic Alarms	61
9.	Timer	62
9.1.1	Timer Beacon.....	62
9.1.2	Logic outputs	62
9.1.3	Power Cycling.....	62
9.2	Dwell Timer	63
9.2.1	Example: End Type (End.T) = OFF Setpoint 1 (SP1) = 70°C.....	63
9.2.2	Example: End Type (End.T) = Dwell Setpoint 1 (SP1) = 70°C	64
9.2.3	Example: End Type (End.T) = SP2 = 20°C Setpoint 1 (SP1) = 70°C	65
9.2.4	To Run a Dwell Type Timer	66
9.2.5	To Hold the Timer	66
9.2.6	To Reset the Timer.....	66
9.2.7	Example: SP1 = 70°C End.T = SP2 = 20°C Ramp Rate (SP.RAT) = 20°C/min.....	67
9.2.8	To Run a Timer Configured as a Simple Programmer.....	68
9.2.9	To Hold the Timer	68
9.2.10	To Reset the Timer	68
9.3	Delayed Switch On Timer	69
9.3.1	Example: Timer Cfg = Dely Setpoint 1 (SP1) = 70°C.....	69
9.3.2	To Run a Delayed Switch-on Timer	70
9.3.3	To Hold the Timer	70
9.3.4	To Reset the Timer.....	70
9.4	Soft Start Timer	71
9.4.1	Example: Timer Cfg = SF.ST Setpoint 1 (SP1) = 70°C	71
9.4.2	To Run a Soft Start Timer	72
9.4.3	To Hold the Timer	72
9.4.4	To Reset the Timer.....	72
9.5	Programmer.....	73
9.5.1	Power Cycling (Programmer).....	73
9.5.2	Threshold.....	73
9.5.3	To Operate the Programmer.....	74
9.5.4	To Configure the Programmer	75
9.6	Timer Parameters	76
9.7	Example: To Configure a Timer as a Simple Two Step Programmer	77
10.	Recipe.....	79
10.1	To Save Values in a Recipe.....	79
10.2	To Save Values in a Second Recipe	79
10.3	To Select a Recipe to Run	80
10.3.1	List of Default Recipe Parameters:	80
11.	Digital Communications	81
11.1	Digital Communications Wiring.....	81
11.1.1	RS232.....	81
11.1.2	RS485.....	82
11.2	Digital Communications Parameters	83
11.2.1	Broadcast Communications.....	84
11.2.2	Broadcast Master Communications	84
11.2.3	Wiring Connections	85
11.3	Example To Set Up Instrument Address	86

11.4	DATA ENCODING	87
11.5	Parameter Modbus Addresses	87
12.	Calibration	100
12.1	Two Point Offset	100
12.2	Input Calibration	101
12.3	Precautions	101
12.3.1	To Calibrate mV Range.....	102
12.3.2	Thermocouple Calibration.....	103
12.3.3	RTD Calibration	104
12.3.4	CT Calibration	105
12.3.5	To Return to Factory Calibration.....	106
12.4	Calibration Parameters	106
13.	Configuration Using iTools	107
13.1	Connecting a PC to the Controller	107
13.1.1	Using the H Communications Port.....	107
13.1.2	Configuration Clip.....	107
13.2	Starting iTools	107
13.3	Configuring a Function	108
13.3.1	Example: To Configure an Alarm.....	108
13.4	To Customise Messages	109
13.4.1	Example: To Customise Alarm 1 Message.....	109
13.4.2	Example 2.....	110
13.5	To Promote Parameters	111
13.5.1	Example: To Change Parameters in the Operator Lists.....	111
13.6	Cloning	112
13.6.1	Save to File	112
13.6.2	To Clone a New Controller	112
13.6.3	To Clone Directly from One Controller to Another.....	112
14.	Appendix A SAFETY and EMC INFORMATION	113
15.	Appendix B TECHNICAL SPECIFICATION	116

1. Installation and Basic Operation

1.1 What Instrument Do I Have?

Thank you for choosing this Temperature Controller.

This Chapter takes you through step by step instructions to help you to install, wire, configure and use the controller. This and other related handbooks can also be downloaded from www.eurotherm.co.uk.

The controller may have been ordered to a hardware code only or pre-configured using an optional 'Quick Start' code. The label fitted to the side of the sleeve shows the ordering code that the controller was supplied to where the last two sets of five digits show the Quick Code. If the Quick Code shows XXXXX/XXXXX the controller will need to be configured when it is first switched on.

1.2 Unpacking Your Controller

The following items are included in the box:-

- Controller mounted in its sleeve
- Two panel retaining clips mounted on the sleeve
- IP65 sealing gasket mounted on the sleeve
- Component packet containing a snubber for each relay output (see section 1.6.1) and a 2.49Ω resistor for current inputs (see section 1.5.3)
- User Guide Part No HA027985 (3216); HA028005 (3116)

1.2.1 Dimensions

A general view of the controller is shown below together with overall dimensions.

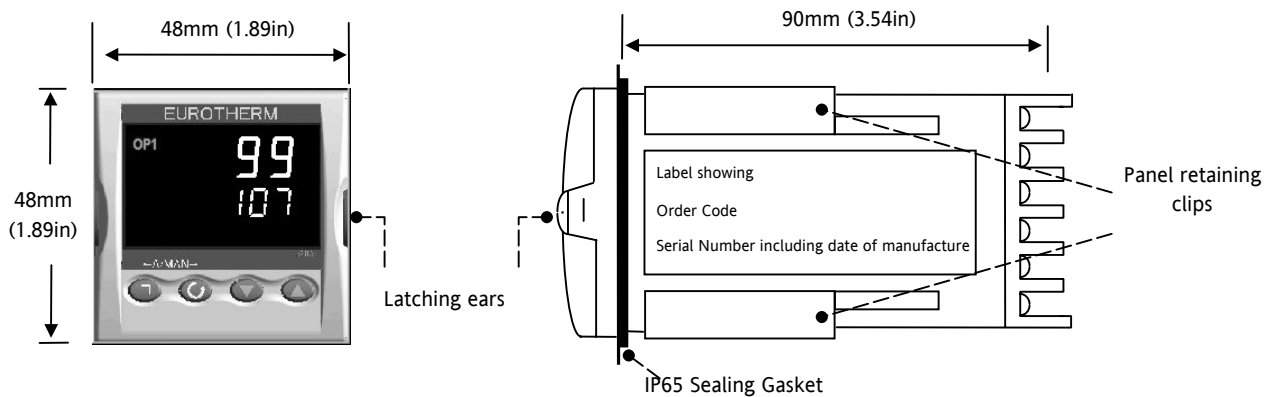

1.3 Order Code

3116

Model		Power supply	Input/output 1 & output 2	X	Output AA	Fascia colour	Product Language	Manual Language	Quick start code
3116	CC								Optional

Power Supply	
VH	110 –240V

Output AA	
R	Relay (Form C)

Product Language Manual Language	
ENG	English
FRA	French
GER	German
SPA	Spanish

Input/output 1 & Output 2		
I/O1	OP2	Code
Logic I/O	Relay	LR
Relay	Relay	RR
Logic I/O	Logic OP	LL

Fascia colour	
G	Green
S	Silver

Quick Start Code	
See Switch On section	

3216

Model		Power supply	Input/output 1 & output 2	X	Output AA	Comms, CT & Dig input	Fascia colour	Product Language	Manual Language	Quick start code
3216										Optional

Model	
CC	Controller
CP	Programmer 1 X 8 segment

Output AA	
R	Relay (Form C)
X	Not fitted

Fascia colour	
G	Green
S	Silver

Power Supply	
VL	20 – 29V
VH	110 –240V

Communications, CT & Digital Input			
X	X	X	Not fitted
4	X	L	RS485 2-wire & Dig in
2	X	L	RS232 2-wire & Dig in
4	C	L	RS485, CT & Dig in
2	C	L	RS232, CT & Dig in
X	X	L	Digital input only
X	C	L	CT & Digital input

Product Language Manual Language	
ENG	English
FRA	French
GER	German
ITA	Italian
SPA	Spanish

Input/output 1 & Output 2		
OP 1	OP 2	
L	X	Logic I/O
L	L	Logic I/O + logic OP
L	R	Logic I/O + relay
R	R	Relay + relay
D	D	DC OP + DC OP
L	D	Logic I/O + DC OP
D	R	DC OP + Relay
X	X	Not fitted

Quick Start Code	
See Switch On section	

1.4 Step 1: Installation

This instrument is intended for permanent installation, for indoor use only, and enclosed in an electrical panel. Select a location which is subject to minimum vibrations and the ambient temperature is within 0 and 55°C (32 - 131°F)

The instrument can be mounted on a panel up to 15mm thick

To ensure IP65 and NEMA 4 front protection, mount on a non-textured surface.

Please read the safety information in Appendix A before proceeding and refer to the EMC Booklet part number HA025464 for further installation information.

1.4.1 Panel Mounting the Controller

1. Prepare a square cut-out in the mounting panel to the size shown below. If a number of controllers are to be mounted in the same panel they should be spaced as shown.
2. Fit the IP65 sealing gasket, if required, behind the front bezel of the controller
3. Insert the controller through the cut-out
4. Spring the panel retaining clips into place. Secure the controller in position by holding it level and pushing both retaining clips forward.
5. Peel off the protective cover from the front of the display

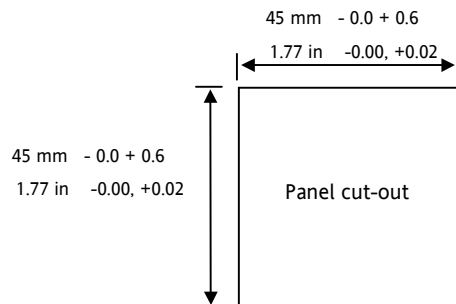

Recommended minimum spacing of controllers

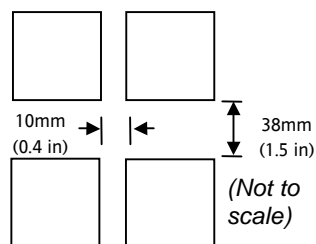

1.4.2 To Remove the Controller from its Sleeve

The controller can be unplugged from its sleeve by easing the latching ears outwards and pulling it forward out of the sleeve. When plugging it back into its sleeve, ensure that the latching ears click back into place to maintain the IP65 sealing.

1.5 Step 2: Wiring

Warning
 Ensure that you have the correct supply for your controller
 Please read the **SAFETY** and **EMC INFORMATION** Appendix A before proceeding
 Check the order code of the controller supplied

1.5.1 Wire Sizes

The screw terminals accept wire sizes from 0.5 to 1.5 mm (16 to 22AWG). Hinged covers prevent hands or metal making accidental contact with live wires. The rear terminal screws should be tightened to 0.4Nm (3.5lb in).

1.5.2 Terminal Layout

3116

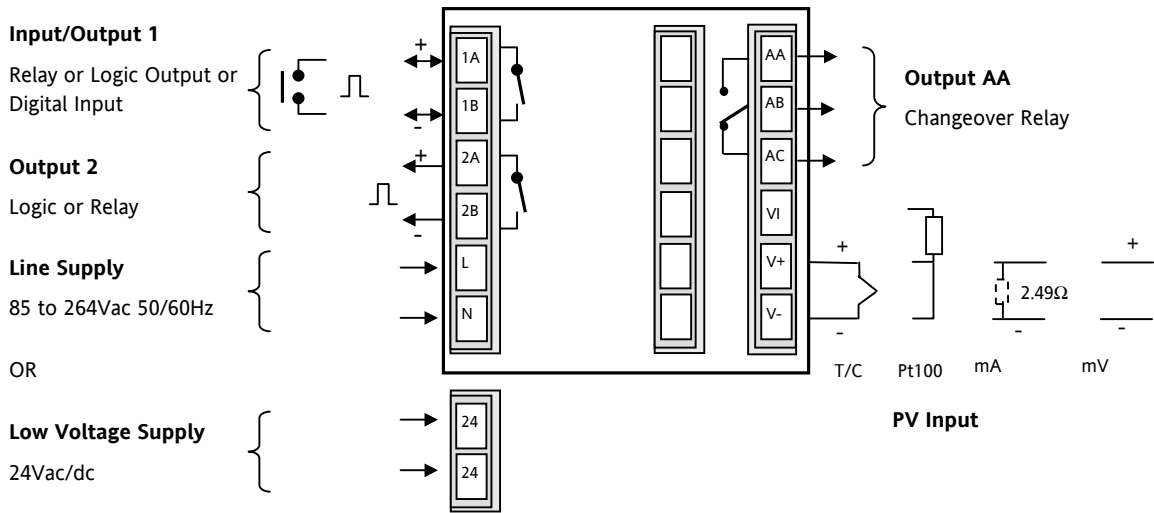

3216

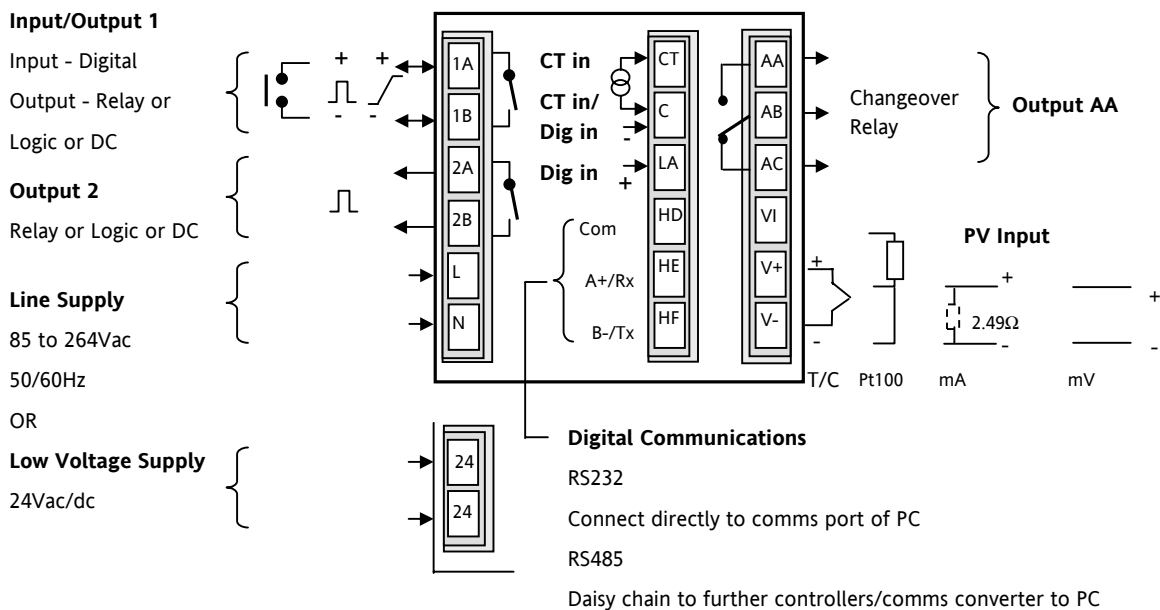

1.5.3 PV Input (Measuring Input)

- Do not run input wires together with power cables
- When shielded cable is used, it should be grounded at one point only
- Any external components (such as zener barriers, etc) connected between sensor and input terminals may cause errors in measurement due to excessive and/or un-balanced line resistance or possible leakage currents

Thermocouple Input

- For thermocouple input use the correct thermocouple compensating cable, preferably shielded

RTD Input

- The resistance of the three wires must be the same. The line resistance may cause errors if it is greater than 22Ω

Linear Input (mA or V)

- A line resistance for voltage inputs may cause measurement errors
- Volts input (input resistance $100K\Omega$). An external adaptor is required, Part No. SUB21/11
- For mA input connect the 2.49Ω burden resistor, supplied, across the + and - input

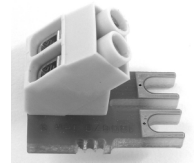

1.5.4 AA Output Relay

- Changeover relay (Form C) rated 2A 264Vac resistive

1.6 Input/Output 1 (Relay or Logic or DC - Optional)

- This is optional and may be logic input, logic or relay output, or 0-20mA dc output (3216 only):-

Output	Relay	Normally open (Form A), 2A 264Vac resistive
	Logic	Drive to SSR (not isolated) Logic level On/High - 12Vdc at 5 to 40mA max Logic level Off/Low - <100mV <100µA
	DC (3216 only)	0-20mA, load 500Ω max, cal accuracy 1% $\pm 100\mu A$ offset
Input	Logic (Digital)	Contact closure 12V @ 5-40mA Contact open > 500Ω Contact closed < 200Ω

1.6.1 Output 2 (Relay or Logic or DC - Optional)

- This is optional and is output only. It may be relay or logic output or 0-20mA dc (3216 only).

General Note About Relays Switching Inductive Loads

High voltage transients may occur when switching inductive loads such as some contactors or solenoid valves. Through the internal contacts, these transients may introduce disturbances which could affect the performance of the instrument.

For this type of load it is recommended that a 'snubber' is connected across the normally open contact of the relay switching the load. The snubber recommended typically consists of a 15nF capacitor and 100Ω resistor connected in series. A snubber will also prolong the life of the relay contacts.

WARNING

When the relay contact is open or it is connected to a high impedance load, the snubber passes a current (typically 0.6mA at 110Vac and 1.2mA at 240Vac). You must ensure that this current will not hold on low power electrical loads. If the load is of this type the snubber should not be connected.

1.6.4 Power Supply

1. Before connecting the instrument to the power line, make sure that the line voltage corresponds to the description on the identification label
2. Use copper conductors only
3. For 24V the polarity is not important
4. The power supply input is not fuse protected. Fuses should be provided externally
 - For 24 V ac/dc fuse type T rated 2A 250V
 - For 85/265Vac fuse type T rated 2A 250V

Safety requirements for permanently connected equipment state:

- A switch or circuit breaker shall be included in the building installation
- It shall be in close proximity to the equipment and within easy reach of the operator
- It shall be marked as the disconnecting device for the equipment

Note: a single switch or circuit breaker can drive more than one instrument

1.6.5 Example Wiring Diagram

This example shows heat/cool temperature controller where the heater control uses a SSR and the cooling control uses a relay.

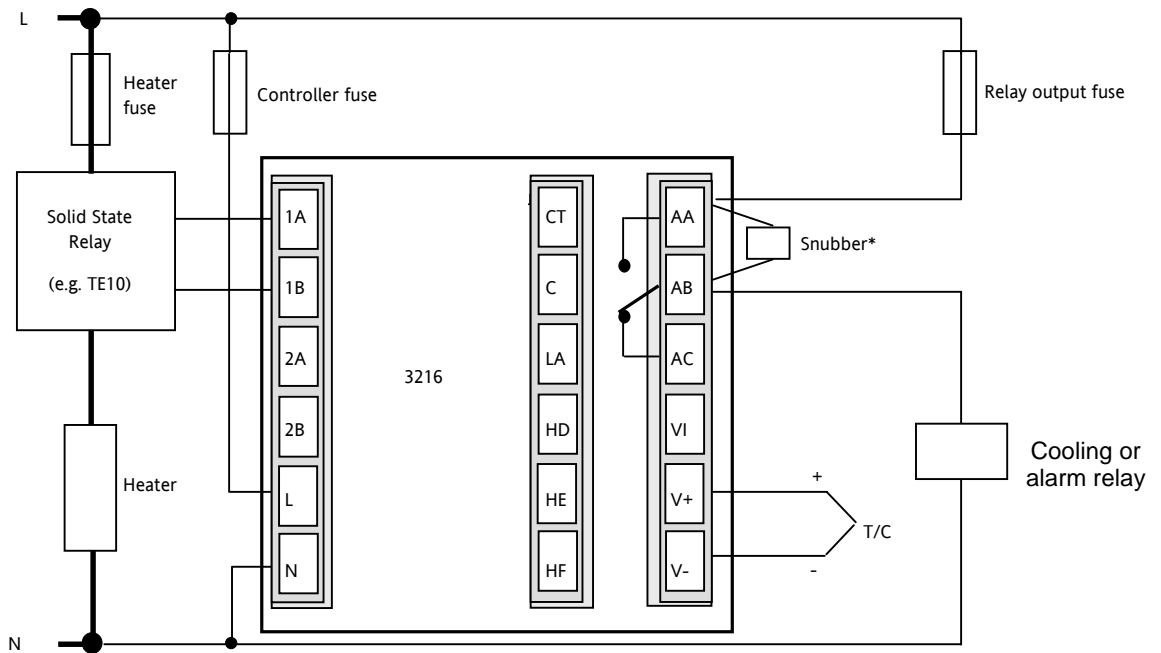

1.7 Step 3: Switch On

A brief start up sequence consists of a self test in which all elements of the display are illuminated and the software version number is shown. What happens next depends on one of two conditions:-

1. The instrument is new and has been supplied un-configured (go to section 1.8)
2. The instrument has been supplied configured in accordance with the Quick Start code (go to section 1.10)

1.8 Initial Configuration

If the controller has not previously been configured it will start up showing the 'Quick Configuration' codes. This is a built in tool which enables you to configure the input type and range, the output functions and the display format.

The quick code consists of two 'SETS' of five characters. The upper section of the display shows the set selected, the lower section shows the five digits which make up the set. Adjust these as follows:-



1. Press any button. The * characters will change to '-' the first one flashing. * indicates the option is not fitted
2. Press or to change the character currently flashing to the required code shown in the quick code tables.
3. Press to scroll to the next character. If you need to return to the first character press . When all five characters have been configured the display will go to Set 2.

When the last digit has been entered press again, the display will show Press or to YES. The controller will automatically go to the operator level. Now go to section 1.10.

SET 1

K C H C O

To configure PV Input type	To configure Range	To configure Input/Output 1		To configure Output 2	To configure Output AA
Thermocouple B = Type B J = Type J K = Type K L = Type L N = Type N R = Type R S = Type S T = Type T C = Custom RTD P = Pt100 PRT Linear M = 0-50mV 2 = 0-20mA 4 = 4-20mA	C = °C Full Range F = °F Full Range 0 = 0-100.0°C 1 = 0-200.0°C 2 = 0-400.0°C 3 = 0-600°C 4 = 0-800°C 5 = 0-1000°C 6 = 0-1200°C 7 = 0-1400°C 8 = 0-1600°C 9 = 0-1800°C G = 32-212.0°F H= 32-392.0°F J= 32-752.0°F K = 32-1112°F L = 32-1472°F M = 32-1832°F N = 32-2192°F P = 32-2552°F R = 32-2912°F T = 32-3272°F	Control OP (relay/logic/DC) Table A		Control OP (relay/logic/DC) Table A	Control OP (relay only) Table A
		Retrans OP – 3216 only (DC only) Table B		Retrans OP – 3216 only (DC only) Table B	
		Alarm OP (relay/logic) Table C		Alarm OP (relay/logic) Table C	Alarm OP (relay only) Table C
		Logic Input Table D			
X In any column = not fitted		Table A Control H = Heat PID C = Cool PID (H & C include 4-20mA) J = Heat On/off (logic & relay); PID (0-20mA) K = Cool On/off (logic & relay); PID (0-20mA)	Table B – 3216 only Retrans 4-20mA D = WSP E = PV F = OP Retrans 0-20mA N = WSP Y = PV Z = OP	Table C Alarm (energised in alarm) 0 = High 1 = Low 2 = Deviation high 3 = Deviation low 4 = Deviation band (de-energised in alarm) 5 = High 6 = Low 7 = Dev high 8 = Dev low 9 = Dev band	Table D Logic Input M = Manual L = Key lock P = Setpoint 2 U = Remote SP comms W = Alarm ack R = Run/hold T = Reset V = Recipe 2/1 select



SET 2

(Not available on 3116)

I W X T

To configure Input CT Scaling	To configure Digital Input	To configure Lower Display
1 = 10 Amps 2 = 25 Amps 5 = 50 Amps 6 = 100 Amps X in any column = Not fitted	W = Alarm Ack M = Manual R = Run/hold L = Keylock P = Setpoint 2 T = Reset U = Remote setpoint comms V = Recipe 2/1 select	T = Setpoint (standard) P = Output power % R = Time to run E = Elapsed time 1 = First Alarm setpoint A = Amps D = Dwell/Ramp N = None

1.9 To Re-Enter Quick Code mode

If you need to re-enter the 'Quick Configuration' mode, power down the controller, hold down the  button, then power up the controller. Keep the button pressed until 'E D E' appears. You must then enter a passcode using the  or  buttons. In a new controller the passcode defaults to 4. If an incorrect passcode is entered you must repeat the whole procedure. You can then re-configure the controller through the Quick Codes.

Note:- If the quick codes re-appear with decimal points between each character this means THE QUICK CODES MAY NO LONGER BE VALID. This is because a parameter (not necessarily a Quick Code parameter) which is available in the controller in a deeper level of access* has been altered. You can, however, re-adjust the Quick Codes again at this point (or proceed to the ^{YES}EXIT state) to re-configure the controller.

* The procedure for a full configuration is described in later chapters of this handbook.

1.10 Pre-Configured Controller or Subsequent Starts

The controller will briefly display the quick codes during start up but will then proceed to operator level 1.

Note:- If the Quick Codes do not appear during start up this means that the controller has been re-configured in a deeper level of access, as stated above, and the Quick Codes may no longer be valid. The controller will power up in mode it was in prior to shutdown and you will see the display shown below. It is called the HOME display.

In this view the controller is in AUTO mode

The OP1 beacon will be on if output 1 is configured for heat and calling for power

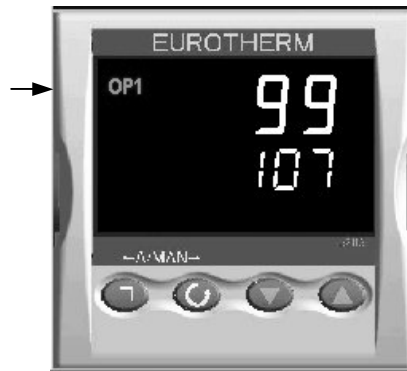

Measured Temperature (or Process Value 'PV')

Required Temperature (or Setpoint 'SP')

1.10.1 Operator Interface



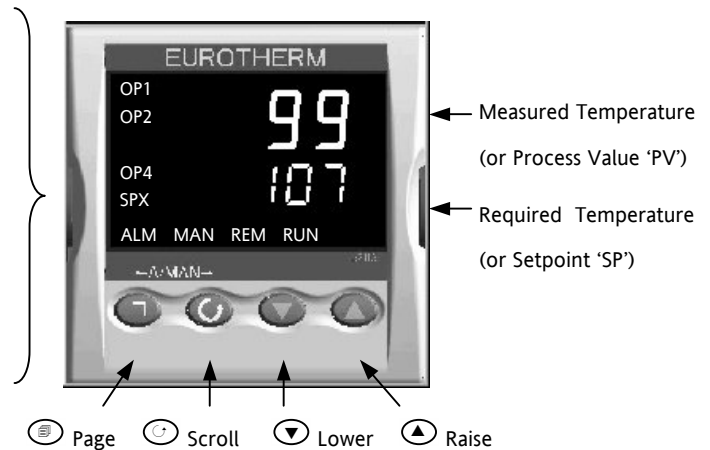

Beacons:-

- OP1** lit when output 1 is ON (normally heating)
- OP2** lit when output 2 is ON (normally cooling)
- OP4** lit when AA relay is ON (normally alarm)
- SPX** Alternative setpoint in use (SP2)
- ALM** Alarm active (Red)
- REM** Remote setpoint or communications active
- RUN** Timer running
- RUN** (flashing) Timer in hold
- MAN** Manual





Operator Buttons

Operator Buttons:-

-  From any display - press to return to the HOME display or select a page header
-  Press to select a new parameter from the page header. If held down it will continuously scroll through parameters.
-  Press to decrease an analogue value or to change the state of a digital (enumerated) value
-  Press to increase an analogue value or to change the state of a digital (enumerated) value

1.10.2 To Set The Required Temperature.

From the HOME display:-

- Press  to raise the setpoint
- Press  to lower the setpoint

The new setpoint is entered when the button is released and is indicated by a brief flash of the display.

1.10.3 Alarm Indication

If an alarm occurs the red ALM beacon will flash, a scrolling message will give the source of the alarm and the alarm (relay) output will operate.

- Press  and  (ACK) together to acknowledge



If the alarm is still present the ALM beacon lights continuously.

The action which takes place depends on the type of alarm configured:-

- Non latching** A non latching alarm will reset itself when the alarm condition is removed
- Auto Latching** An auto latching alarm requires acknowledgement before it is reset. The acknowledgement can occur BEFORE the condition causing the alarm is removed.
- Manual Latching** The alarm continues to be active until both the alarm condition is removed AND the alarm is acknowledged. The acknowledgement can only occur AFTER the condition causing the alarm is removed.

1.10.4 Auto/Manual/Off Mode



Auto mode is the normal closed loop operation where the output is adjusted automatically by the controller in response to a change in the input signal.







Manual mode means that the controller output power can be adjusted directly by the user. The input sensor is still connected and reading the PV but the control loop is open. The current level of the power output is adopted at the point of switch over from Auto to Manual. This is referred to as 'Bumpless Transfer'. The power output can be increased or decreased using the  or  buttons. Similarly, when Manual to Auto is selected the current manual output power is taken and the controller will then take over control. If the controller is powered down it will resume the same mode when powered up again.

Off mode can be selected (in Operator Level 2, see section 1.11) or when using a timer configured to turn the power output off at the end of a timed period.

 Manual operation must be used with care and the power level set must be chosen such that no damage can occur to the process. The use of a separate 'over-temperature' controller is recommended.

1.10.5 To Select Auto/Manual and Adjust the Output Power

Press  and  (Mode) together. This can only be accessed from the HOME display.

1. 'Auto' is shown in the upper display. The lower display will scroll the longer alternate description of this parameter, ie 'LOOP MODE - AUTO M ANUAL OFF'
2. Press  to select 'mAn'. This is shown in the upper display and the **MAN** beacon is lit.
3. The controller will return to the HOME display. The upper display shows PV. The lower display shows demand power. At the point of changeover the manual demand power is the same as it was when in Auto (bumpless transfer auto to manual).
4. Press  or  to lower or raise the power. The output power is continuously updated when these buttons are pressed
5. The loop can also be turned off (zero power output demand) by selecting 'OFF' in the upper display. Loop break is also turned off. The controller will return to the HOME display. The upper display shows the PV. The lower display shows OFF. The **MAN** beacon is lit in this mode.
6. To Return to Automatic operation, press  or  together. Then press  to select 'Auto'. At the point of changeover to automatic operation the power demand takes the current value and gradually changes to that required by the controller (bumpless transfer manual to auto)







1.10.6 Other Commonly Used Operator Parameters Available in Level 1

Operator level 1 is designed for day to day operation of the controller and parameters are not protected by a security code.

Press  to scroll through a list of commonly used parameters.







A list of other operating parameters is available each time this button is pressed. The parameter mnemonic and its scrolling description are shown in the lower display. The value of the parameter is shown in the upper display. The actual parameters shown depend upon the functions configured and are:-

Parameter Mnemonic and Scrolling Display	Description	Alterability
WRK.OP WORKING OUTPUT	The current output	Only shown when the controller is in AUTO mode and is read only
WKG.SP WORKING SETPOINT	The setpoint which the controller is currently using	Only shown when the controller is in MAN mode and is read only
SP1 (or 2) SETPOINT 1 (or 2)	To adjust setpoint 1 (or 2)	Press  or  to adjust
T.REMN TIME REMAINING	Time to end of set timer period	Read only 0:00 to 99.59 hh:mm or mm:ss
DWELL SET TIME DURATION	Set dwell time	Only shown if timer (not programmer) configured. Alterable using  or 
AX.YY ALARM X SETPOINT X= alarm number YY= alarm type	Alarm 1, 2, 3 or 4 setpoint (if the alarm is configured)	Read only
LD.AMP LOAD CURRENT	Load current	Read only and only shown if CT is configured

1.11 Operator Level 2

Level 2 provides access to additional parameters and access to these is protected by a security code.

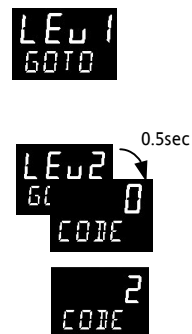

1.11.1 To Enter Level 2

1. From any display press and hold .
2. After a few seconds the display will show 'LEU 1 GOTO'.
3. Release .
- (If no button is pressed for about 45 seconds the display returns to the HOME display)
4. Press  or  to choose LEU 2 (Level 2)
5. Press  or  to enter the correct code
6. By default this is set to '2'







If an incorrect code is entered the display reverts to Level 1.

1.11.2 To Return to Level 1

1. Press and hold .
2. Press  to select LEU 1

It is not necessary to enter a code when going from a higher level to a lower level.
When Level 1 is selected the display reverts to the HOME display

1.12 Level 2 Parameters

Press  to scroll through the list of parameters. The mnemonic of the parameter is shown in the lower display, followed once by a scrolling help message showing a longer description of the parameter.
The value of the parameter is shown in the upper display. Press  or  to adjust this value. If no key is pressed for about 30 seconds the display returns to 'HOME'
Backscroll is achieved when you are in the list by pressing  while holding down .

Mnemonic	Scrolling Display and description	Range
WKG.SP	WORKING SETPOINT is the current target setpoint and appears when the controller is in Manual. It may be derived from SP1 or SP2, or, if the controller is ramping (see SP.RAT), it is the current ramp value.	SP.HI to SP.LO
WRK.OP	WORKING OUTPUT is the output from the controller expressed as a percentage of full output. It appears when the controller is in Auto. Range -100% (Max cooling) to +100% (max heating). For a time proportioning output, 50% = relay or logic output on or off for equal lengths of time. For an On/Off output 0 to <1% = output off, >1 to 100% = output on	0 to 100% heat only -100 to 100% heat + cool
T.STAT	TIMER STATUS is only shown if a timer is configured. Allows the timer to be put into Run, Hold or Reset mode.	rES Reset run Running hoLd Hold End Timed out
UNITS	DISPLAY UNITS	°C Degree s C

Mnemonic	Scrolling Display and description	Range
		$^{\circ}F$ Degree s F
		$^{\circ}K$ Degree s K
		<i>nonE</i> None
		<i>PERc</i> Percent age
SP.HI	SETPOINT HIGH allows a high limit to be applied to SP1 and SP2	As quickcode SET1
SP.LO	SETPOINT LOW allows a low limit to be applied to SP1 and SP2	
SP1	SETPOINT 1 allows the value of setpoint 1 to be adjusted	SP.HI to SP.LO
SP2	SETPOINT 2 allows the value of setpoint 2 to be adjusted	SP.HI to SP.LO
SP.RAT	SETPOINT RATE LIMIT sets the rate of change of setpoint. Limits the rate of heating or cooling.	OFF to 3000 display units per minute

This section applies to the Timer only		
TM.CFG	TIMER CONFIGURATION configures the timer type - Dwell, Delay, Soft Start or none (only when in Reset) Note Programmer option is only shown if the programmer option has been ordered.	<i>nonE</i> None <i>dwE11</i> Dwell <i>dELY</i> Delayed switch on <i>SFSt</i> Soft start <i>Prog</i> Progra mmer
TM.RES	TIMER RESOLUTION selects hours or minutes (only when in Reset)	<i>Hour</i> Hours <i>mi n</i> Minutes
THRES	TIMER START THRESHOLD The timer will not run until the PV becomes in range of the value set by this parameter. This value can be changed when the timer is running.	OFF or 1 to 3000
END.T	TIMER END TYPE The action of the timer when it has timed out can be selected from Dwell (control continues at the setpoint), Off (control outputs turn off), SP2 (control at setpoint 2). Can be changed while the timer is running.	<i>OFF</i> Control OP goes to zero <i>dwE11</i> Control continu es at SP1 <i>SP2</i> Go to SP2
SS.PWR	SOFT START POWER LIMIT Sets the power limit during start up	-100 to 100%
SS.SP	SOFT START SETPOINT sets the threshold below which the power is limited	Between SP.HI and SP.LO
DWELL	SET TIME DURATION - can be adjusted while the timer is running. This parameter only appears for a Dwell type timer.	0:00 to 99.59 hh:mm: or mm:ss
T.REMN	TIME REMAINING Time remaining to reach the set time	0:00 to 99.59 hh:mm: or mm:ss

The following parameters are available when the timer is configured as a programmer (3216 only)		
SERVO	SERVO MODE. The program will start from the current setpoint value or from the current value of the process variable	<i>SP</i> Setpoint <i>PU</i> Process variable
TSP.1	TARGET SETPOINT 1. To set the target value for the first setpoint	
RMP.1	RAMP RATE 1. To set the first ramp rate	
DWEL.1	DWELL 1. To set the period of the first dwell	
The above three parameters are repeated for the next three program segments, i.e. TSP.2 (3 & 4), RMP.2 (3 & 4), DWEL.2 (3 & 4)		

This section applies to Alarms only If an alarm is not configured the parameters do not appear		

Mnemonic	Scrolling Display and description	Range
A1.--- - to A4.---	ALARM 1 (2, 3 or 4) SETPOINT sets the threshold value at which an alarm is detected. Up to four alarms are available and are only shown if configured. --- = the mnemonic for the alarm type which may be:- L 0 Full Scale 0 N 0 Deviation Band 0 H 1 Deviation High H 1 Full Scale 0 L 0 Deviation Low High	SP.HI to SP.LO
This section applies to control parameters		
A.TUNE	AUTOTUNE automatically sets the control parameters to match the process characteristics.	OFF Disable On Enable
PB	PROPORTIONAL BAND sets an output which is proportional to the size of the error signal. Units may be % or display units.	1 to 9999 display units
TI	INTEGRAL TIME removes steady state control offsets by ramping the output up or down in proportion to the amplitude and duration of the error signal.	OFF to 9999 seconds
TD	DERIVATIVE TIME determines how strongly the controller will react to the rate of change in the process value. It is used to prevent overshoot and undershoot and to restore the PV rapidly if there is a sudden change in demand.	OFF to 9999 seconds
MR	MANUAL RESET applies to a PD only controller i.e. the integral term is turned off. Set this to a value of power output (from +100% heat, to -100% cool which removes any steady state error between SP and PV.	-100 to 100%
R2G	RELATIVE COOL GAIN adjusts the cooling proportional band relative to the heating proportional band. Particularly necessary if the rate of heating and rate of cooling are very different. (Heat/Cool only)	0.1 to 10.0
HYST.H	HEATING HYSTERESIS sets the difference in PV units between output 1 turning off and turning on. Only shown if channel 1 control action is On/Off.	0.1 to 200.0 display units
HYST.C	COOLING HYSTERESIS sets the difference in PV units between output 2 turning off and turning on. Only shown if channel 2 control action is On/Off.	0.1 to 200.0 display units
D.BAND	CHANNEL 2 DEADBAND adjusts a zone between heating and cooling outputs when neither output is on. Off = no deadband. 100 = heating and cooling off. On/Off controllers only.	OFF or 0.1 to 100.0% of the cooling proportional band
OP.HI	OUTPUT HIGH limits the maximum heating power applied to the process or a minimum cooling output.	+100% to OP.LO
1. (2 or 4) PLS.	OUTPUT 1 (2 or AA) MINIMUM PULSE TIME to set the minimum on/off time for the output. Relay outputs are adjustable from 0.1 to 150 seconds. Logic outputs set to Auto = 55ms.	Auto to 150.0
----- This section applies to current transformer input only. If the CT option is not configured the parameters do not appear		
LD.AMP	LOAD CURRENT is the measured load current when the power demand is on	CT Range
LK.AMP	LEAK CURRENT is the measured leakage current when the power demand is off.	CT Range
LD.ALM	LOAD CURRENT THRESHOLD sets a low alarm trip point for the load current as measured by the CT. This detects partial load failure.	CT Range
LK.ALM	LEAK CURRENT THRESHOLD sets a high alarm trip point for the leakage current measured by the CT.	CT Range
HC.ALM	OVERCURRENT THRESHOLD sets a high alarm trip point to show over current as measured by the CT	CT Range
ADDR	ADDRESS - communications address of the controller. 1 to 254	1 to 254

Mnemonic	Scrolling Display and description	Range
HOME	HOME DISPLAY Defines the parameter which appears in the lower section of the HOME display	<i>Std</i> Standard <i>OP</i> Output power <i>Er</i> Time remaining <i>ELAP</i> Time elapsed <i>AL</i> First alarm setpoint <i>Et</i> Load current <i>ELr</i> Clear (blank) <i>Emr</i> Combined setpoint and time display
ID	CUSTOMER ID is a number from 0 to 9999 entered as a customised identification number for the controller	0 to 9999
REC.NO	CURRENT RECIPE NUMBER the most frequently used parameters can be stored in up to 5 recipes. This parameter selects the recipe to use.	<i>nonE</i> or <i>1 to 5</i> or <i>FRi L</i> if no recipe set stored
STORE	RECIPE TO SAVE the most frequently used parameter s can be stored in up to 5 recipes. This parameter allows you to store the current values in recipe numbers 1, 2, 3, 4, or 5. 'None' does not store values.	<i>nonE</i> or <i>1 to 5</i> <i>donE</i> when stored

* Available in Level 1 and level 2

☺ Press  at any time to return immediately to the HOME screen at the top of the list.

☺ Hold  down to continuously scroll through the above list

2. Access to Further Parameters

Parameters are available under different levels of security and are defined as Level 1 (LEVEL 1), Level 2 (LEVEL 2), Level 3 (LEVEL 3) and Configuration (CONF). Level 1 has no security password since it contains a minimal set of parameters generally sufficient to run the process on a daily basis. Level 2 allows parameters, generally used in commissioning a controller, to be adjusted. This has been described in the previous section.

Level 3 and Configuration level parameters are also available as follows:-

2.1.1 Level 3

Level 3 makes all operating parameters available and alterable (if not read only)

Examples are:-

Range limits, setting alarm levels, communications address.

The instrument will continue to control when in Levels 1, 2 or 3.

2.1.2 Configuration Level

This level makes available all parameters including the operating parameters so that there is no need to switch between configuration and operation levels during commissioning. It is designed for those who may wish to change the fundamental characteristics of the instrument to match the process.

Examples are:-

Input (thermocouple type); Alarm type; Communications type.











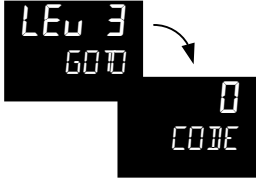

WARNING

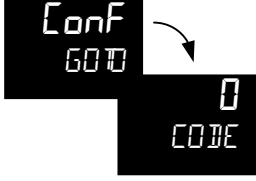
Configuration level gives access to a wide range of parameters which match the controller to the process. Incorrect configuration could result in damage to the process being controlled and/or personal injury. It is the responsibility of the person commissioning the process to ensure that the configuration is correct.

In configuration level the controller is not controlling the process or providing alarm indication. Do not select configuration level on a live process.

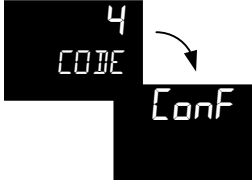
Operating Level	Home List	Full Operator	Configuration	Control
Level 1	✓			Yes
Level 2	✓			Yes
Level 3	✓	✓		Yes
Configuration	✓	✓	✓	No

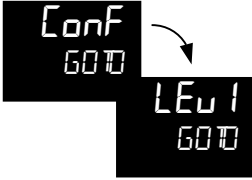
2.1.3 To Select Access Level 3 or Configuration Level

Do This	The Display You Should See	Additional Notes
<p>1. From any display press and hold  for more than 5 seconds</p>	<p style="text-align: center;">To Select Level 3</p> 	<p>The display will pass from the current operating level, for example, LEU 1 to LEU 3 as the button is held down.</p> <p>(If no button is then pressed for about 50 seconds the display returns to the HOME display)</p>
<p>2. Press  or  to enter the passcode for Level 3</p>		<p>The default code is 3:</p> <p>If an incorrect code is entered the display reverts to 'GOTO'.</p> <p>The controller is now in the level 3 will then revert to the HOME display</p>
<p>3. From 1 above, press  to go to 'CONF'</p>	<p style="text-align: center;">To Select Configuration level</p> 	<p>Note:  must be pressed before the controller requests the code for level 3</p>
<p>4. Press  or  to enter the passcode for Configuration level</p>		<p>The default code is 4:</p> <p>If an incorrect code is entered the display reverts to 'GOTO'.</p> <p>The controller is now in Configuration level will now show CONF</p>
<p>5. Press and hold  for more than 3 seconds</p> <p>6. Press  to select the required level eg LEU 1</p>	<p style="text-align: center;">To Return to a Lower Level</p> 	<p>The choices are:</p> <ul style="list-style-type: none"> LEU 1 Level 1 LEU 2 Level 2 LEU 3 Level 3 CONF Configuration <p>It is not necessary to enter a code when going from a higher level to a lower level.</p> <p>Alternatively, press  and scroll to the ACCESS list header, then press  to select the required level.</p> <p>The display will then flash 'CONF' for a few seconds and the controller will then go through its start up sequence, starting in the level selected.</p> <p>Do not power down while CONF is flashing. If a power down does occur an error message will appear – see section 8.4 'Diagnostic Alarms'</p>

 A special case exists if a security code has been configured as '0' If this has been done it is not necessary to enter a code and the controller will enter the chosen level immediately.

 When the controller is in configuration level the ACCESS list header can be selected from any view by holding down the  button for more than 3 seconds. Then press  again to select 'ACCESS'

2.2 Parameter lists

Parameters are organised in simple lists. The top of the list shows the list header only. The name of the list header describes the generic function of the parameters within the list. For example, the list header 'ALARM' contains parameters which enable you to set up alarm conditions.

2.2.1 To Choose Parameter List Headers

Press . Each list header is selected in turn every time this key is pressed.

The list header name appears in the lower display, followed immediately by a scrolling longer description of the name.

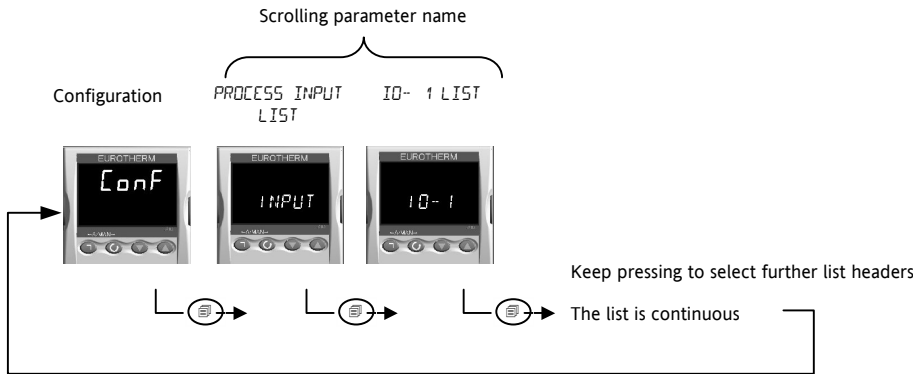

The following example shows how to select the first two list headers.

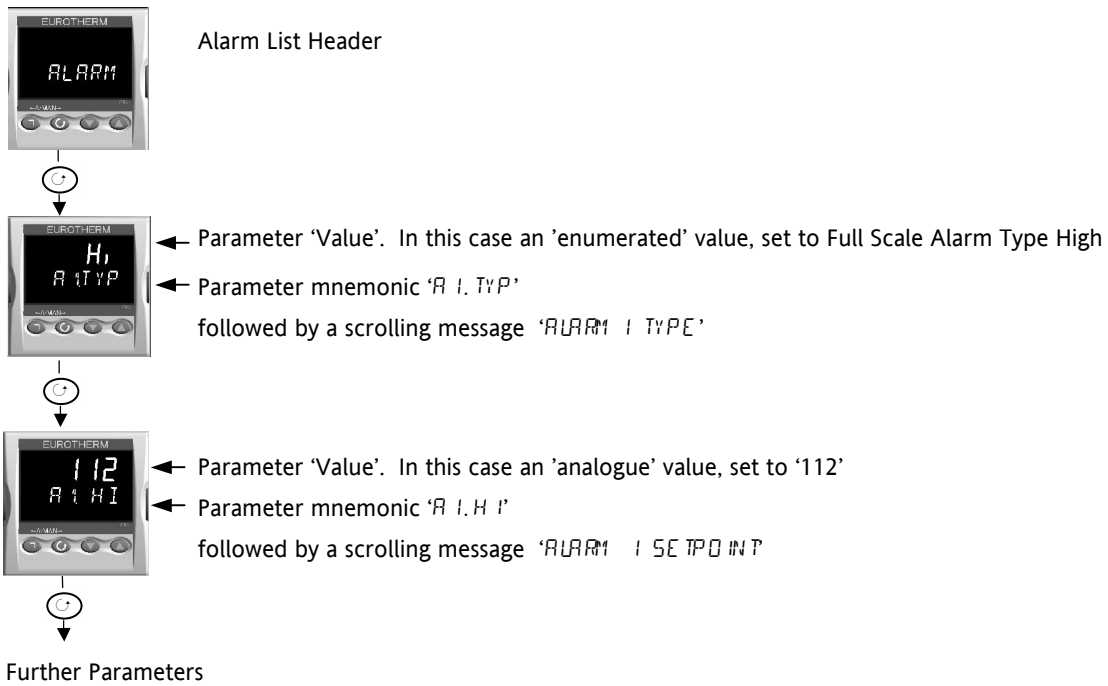

2.2.2 To Locate a Parameter

Choose the appropriate list, then press . Each parameter in the list is selected in turn each time this button is pressed. The following example shows how to select the first two parameters in the ALARM List. All parameters in all lists follow the same procedure.



 Press  to jump back to the list header.

2.2.3 How Parameters are Displayed

As shown above, whenever a parameter is selected it is displayed as a mnemonic, of four or five characters, for example 'R I T Y P'.

After a few seconds this display is replaced by a scrolling banner which gives a more detailed description of the parameter. In this example 'R I T Y P' = 'ALARM I TYPE'. The scrolling banner is only shown once when the parameter is first accessed.

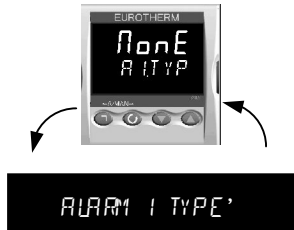

The name of the list header is also displayed in this way.



The upper part of the display shows the value of the parameter.

The lower part shows its mnemonic followed by the scrolling name of the parameter

2.2.4 To Change a Parameter Value

With the parameter selected, press  to increase the value, press  to decrease the value. If either key is held down the analogue value changes at an increasing rate.

The new value is entered after the key is released and is indicated by the display blinking. The exception to this is output 'Power' when in manual. In this case the value is entered continuously.

The upper display shows the parameter value the lower display shows the parameter name.





2.2.5 To Return to the HOME Display

Press  + .

On release of the keys the display returns to the HOME list. The current operating level remains unchanged.

2.2.6 Time Out

A time out applies to the 'Go To' and 'Control Mode' parameters. If no key presses are detected within a period of 5 seconds the display will revert back to the HOME list.

 Press and hold  to scroll parameters forward through the list. With  depressed, press  to scroll parameters backward.

2.3 Navigation Diagram



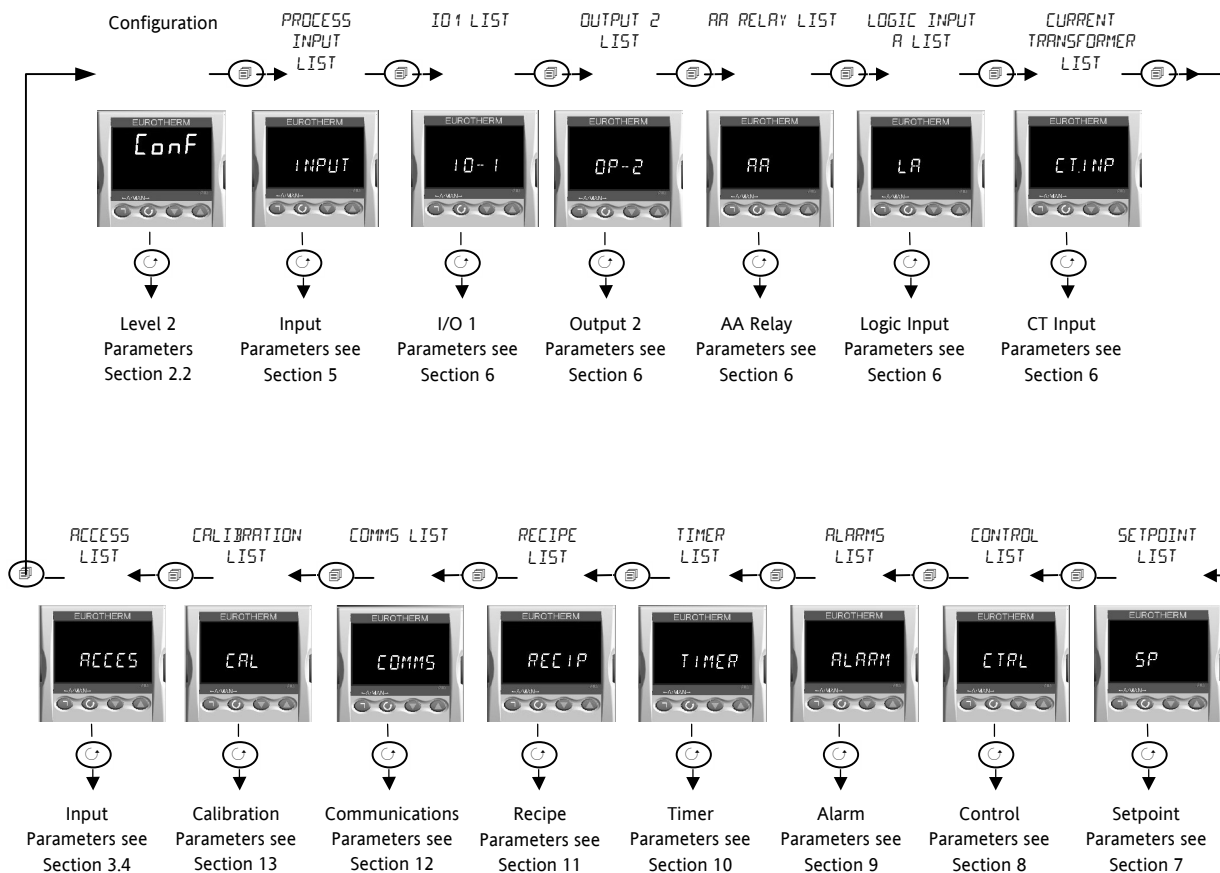

The diagram below shows the all list headings available in configuration level for 3116 and 3216 controllers. The parameters in a list are shown in tables in the following sections of this manual together with explanations of their meanings and possible use.





The above diagram is shown for 3216 controllers. For 3116 AA Relay List, Logic List, CT Input List and Comms List are not present.

2.4 Access Parameters

The following table summarizes the parameters available under the ACCESS list header

 The Access List can be selected at any time when in configuration level by holding  key down for 3 seconds, then press  or  with  still held down.

ACCESS LIST		'ACCESS'				
Name	Scrolling Display	Parameter Description	Values Allowed		Default	Access Level
GOTO	GOTO	Allows the user to change the access level of the controller. Passwords prevent accidental edit	LEU.1 LEU.2 LEU.3 CONF	Operator mode level 1 Operator mode level 2 Operator mode level 3 Configuration level	LEU.1	Conf
LEV2.P	LEVEL 2 PASSCODE	Level 2 passcode	0-9999 0 = no passcode will be requested		2	Conf
LEV3.P	LEVEL 3 PASSCODE	Level 3 passcode			3	Conf
CONF.P	CONFIG PASSCODE	Configuration level passcode			4	Conf
ID	CUSTOMER ID	To set the identification of the controller	0-9999			Conf
HOME	HOME DISPLAY	To configure the parameter to be displayed in the lower line of the HOME display	SP OP Tr ELAP AL1 CT CLR Tmr	Setpoint Output demand Time remaining Time elapsed Alarm 1 setpoint Current transformer No parameter Time remaining	SP	Conf
K.LOCK	KEYBOARD LOCK	To limit operation of the front panel buttons when in operator levels	nonE	Unlocked	nonE	Conf
			ALL	All buttons locked		
			Edi E	Edit keys locked ⁽¹⁾		
			mod	Mode key locked ⁽²⁾		
			mAn	Manual mode locked		
			Stby	Press  and  to toggle between normal operation and standby mode		
CLR	COLD START ENABLE/DISABLE	This parameter should be used with care. When set to yes the controller will return to factory settings on the next power up	No YES	Disable Enable		Conf
STBY.T	STANDBY TYPE	Turn ALL outputs off when the controller is in standby mode. Typical use when event alarms are being used to interlock a process.	ABSA	Absolute alarms to remain active	ABSA	Conf
			OFF	All alarms off in standby		

Note 1

Edit keys locked. Parameters cannot be changed but viewed only. However, it is possible to run, hold and reset timer and acknowledge alarms.

Note 2

Mode key locked. Timer run, hold, reset and Auto/Manual cannot be operated from the Mode key.

The following sections in this handbook describe the parameters associated with each subject. The general format of these sections is a description of the subject, followed by the table of all parameters to be found in the list, followed by an example of how to configure or set up parameters.

3. Controller Block Diagram

The block diagram shows the simple building blocks which make up the controller. Each block has a list of parameters headed by a list name. For example the 'Input List' contains parameters which define the input type. The quick start code automatically sets the parameters to match the hardware.

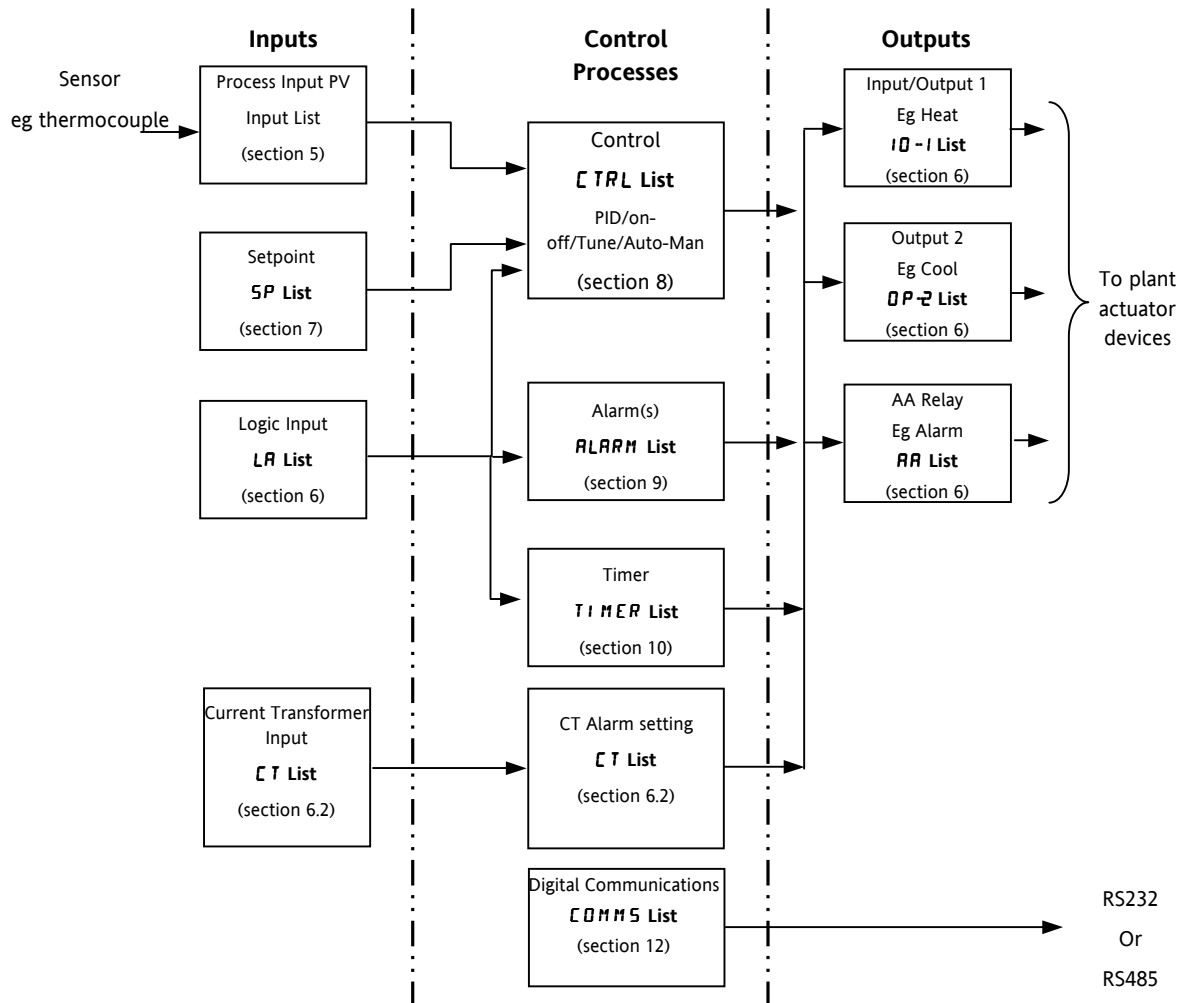

The Process Variable (PV) is measured by the sensor and compared with a Setpoint (SP) set by the user.

The purpose of the control block is to reduce the difference between SP and PV (the error signal) to zero by providing a compensating output to the plant via the output driver blocks.

The timer and alarms blocks may be made to operate on a number of parameters within the controller, and digital communications provides an interface to data collection and control.

The way in which each block performs is defined by its internal parameters. Some of these parameters are available to the user so that they can be adjusted to suit the characteristics of the process which is to be controlled.

These parameters are found in lists and the name of each list corresponds with the name of the function block shown in the above diagram.

The above block diagram applies to 3216 controllers. For 3116 Logic Input List, CT Input List, Timer List, Digital Communications List, AA Relay List and Output 3 List are not present.

4. Process Input

Parameters in the process input list configure the input to match your sensor. The Process Input parameters provide the following features:-

Input Type and linearisation	Thermocouple (TC) and 3-wire resistance thermometer (RTD) temperature detectors Linear input (-10 to +80mV) through external shunt or voltage divider, mA assumes a 2.49 Ω external shunt. See the table in section 4.1.1. for the list of input types available
Display units and resolution	The change of display units and resolution will all the parameters related to the process variable
Input filter	First order filter to provide damping of the input signal. This may be necessary to prevent the effects of excessive process noise on the PV input from causing poor control and indication. More typically used with linear process inputs.
Fault detection	Sensor break is indicated by an alarm message 'Sbr'. For thermocouple it detects when the impedance is greater than pre-defined levels; for RTD when the resistance is less than 12 Ω .
User calibration	Either by simple offset or by slope and gain. See section 4.2. for further details.
Over/Under range	When the input signal exceeds the input span by more than 5% the PV will flash indicating under or over range. If the value is too high to fit the the number of characters on the display 'HHHH' or 'LLLL' will flash. The same indications apply when the display is not able to show the PV, for example, when the input is greater than 999.9 $^{\circ}$ C with one decimal point.

4.1 Process Input Parameters

INPUT LIST INPUT						
Name	Scrolling Display	Parameter Description	Value		Default	Access Level
<i>IN.TYP</i>	INPUT TYPE	Selects input linearisation and range	See section 4.1.1. for input types available			Conf L3 R/O
<i>UNITS</i>	DISPLAY UNITS	Display units shown on the instrument	<i>none</i> <i>°C</i> <i>°F</i> <i>°K</i> <i>PERC</i>	No units - only for custom linearisation Celsius Fahrenheit Kelvin %	<i>°C</i>	L3
<i>DECP</i>	DISPLAY POINTS	Decimal point position	<i>none</i> <i>none</i> <i>none</i>	No DP One DP Two DP	<i>none</i>	Conf L3 R/O
<i>MV.HI</i>	LINEAR INPUT HIGH	High limit for mV (mA) inputs	-10.00 to +80.00mV		<i>80.00</i>	Conf
<i>MV.LO</i>	LINEAR INPUT LOW	Low limit for mV (mA) inputs	-10.00 to +80.00mV		<i>- 10.00</i>	Conf
<i>RNG.HI</i>	RANGE HIGH LIMIT	Range high limit for thermocouple RTD and mV inputs	From the 'Low Range Limit' parameter plus one display unit to the high limit of the selected input type. See Section 4.3 for further details			Conf L3 R/O
<i>RNG.LO</i>	RANGE LOW LIMIT	Range low limit for thermocouple RTD and mV inputs	From the low limit of the selected input type to the 'High Range Limit' parameter minus one display unit. See Section 4.3 for further details			Conf L3 R/O
<i>PV.OFS</i>	PV OFFSET	A simple offset applied to all input values. See section 4.2.1.	Generally one decimal point more than PV			L3
<i>FILT.T</i>	FILTER TIME	Input filter time	OFF to 59.9 seconds		<i>16</i>	L3
<i>CJC.TYP</i>	CJC TYPE	Configuration of the CJC type	<i>Auto</i> <i>0°C</i>	Automatic Fixed at 0°C	<i>Auto</i>	Conf and if T/C L3 R/O
<i>SB.TYP</i>	SENSOR BREAK TYPE	Defines the action which is applied to the output if the sensor breaks (open circuit)	<i>OFF</i> <i>ON</i> <i>LATCH</i>	No sensor break will be detected Open circuit sensor will be detected Latching	<i>ON</i>	Conf L3 R/O
<i>CJC.IN</i>	CJC TEMPERATURE	Temperature measured at the rear terminal block used in the CJC calculation	Read only			Conf L3 R/O and if T/C
<i>PV.IN</i>	PV INPUT VALUE	Current measured value of the process variable	Minimum display to maximum display range			Conf L3 R/O
<i>MV.IN</i>	MILLIVOLT INPUT VALUE	Millivolts measured at the rear PV Input terminals	xx.xx mV - read only			Conf L3 R/O

4.1.1 Input Types and Ranges

Input Type		Min Range	Max Range	Units	Min Range	Max Range	Units
Jtc	Thermocouple type J	-210	1200	°C	-238	2192	°F
Ktc	Thermocouple type K	-200	1372	°C	-238	2498	°F
Ltc	Thermocouple type L	-200	900	°C	-238	1652	°F
Rtc	Thermocouple type R	-50	1700	°C	-58	3124	°F
Btc	Thermocouple type B	0	1820	°C	-32	3308	°F
Ntc	Thermocouple type N	-200	1300	°C	-238	2372	°F
Ttc	Thermocouple type T	-200	400	°C	-238	752	°F
Stc	Thermocouple type S	-50	1768	°C	-58	3214	°F
Pt100	Pt100 resistance thermometer	-200	850	°C	-238	1562	°F
mV	mV or mA linear input	-10.00	80.00				
CM5	Value received over digital communications (modbus address 203). This value must be updated every 5 seconds or the controller will revert to SP1 or SP2						

4.2 PV Offset

All ranges of the controller have been calibrated against traceable reference standards. This means that if the input type is changed it is not necessary to calibrate the controller. There may be occasions, however, when you wish to apply an offset to the standard calibration to take account of known errors within the process, for example, a known sensor error or a known error due to the positioning of the sensor. In these instances it is not advisable to change the reference (factory) calibration, but to apply a user defined offset.

PV Offset applies a single offset over the full display range of the controller and can be adjusted in Level 3. It has the effect of moving the curve up a down about a central point as shown in the example below:-

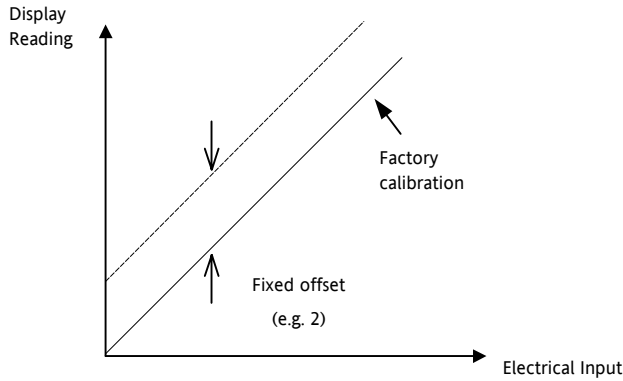







4.2.1 Example: To Apply an Offset:-

Connect the input of the controller to the source device which you wish to calibrate to

Set the source to the desired calibration value

The controller will display the current measurement of the value

If the display is correct, the controller is correctly calibrated and no further action is necessary. If you wish to offset the reading:-

Do This	The Display You Should See	Additional Notes
1. Select Level 3 or Conf as described in Chapter 2. Then press  to select ' INPUT '		Scrolling display ' <i>PROCESS INPUT LIST</i> '
2. Press  to scroll to ' PV.OFS '		Scrolling display ' <i>PV OFFSET</i> ' In this case an offset of 2.0 units is applied
3. Press  or  to adjust the offset to the reading you require		

It is also possible to apply a two point offset which adjusts both low and high points. This is done in Level 3 using the CAL List, and the procedure is described in the Calibration section 12.

4.3 PV Input Scaling

PV input scaling applies to the linear mV input range only. This is set by configuring the INPUT TYPE parameter to mV and has an input range of -10 to 80mV. Using an external burden resistor of 2.49Ω, the controller can be made to accept 4-20mA from a current source. Scaling of the PV input will match the displayed reading to the electrical input levels from the transducer. PV input scaling can only be adjusted in Configuration level and is not provided for direct thermocouple or RTD inputs.

The graph below shows an example of input scaling, where it is required to display 2.0 when the input is 4mV and 500.0 when the input is 20mV .

If the input exceeds ±5% of the mV.Lo or mV.Hi settings, sensor break will be displayed.

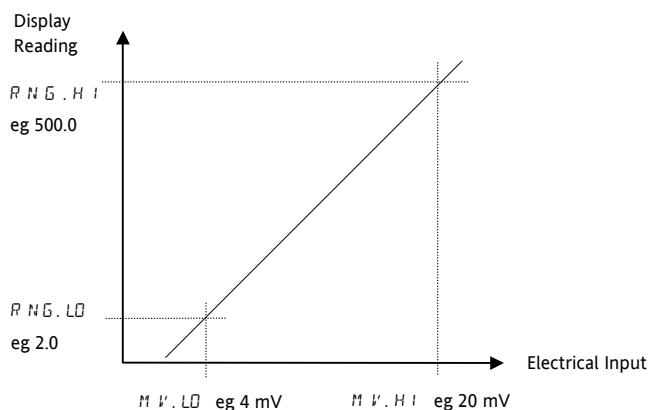

For mA inputs
 4-20mA = 9.96-49.8mV with 2.49Ω load resistor
 0-20mA = 0-49.8mV with 2.49Ω load resistor
 mA input will detect sensor break if mA < 3mA
 Use a current source to remove shunt resistor errors

4.3.1 Example: To Scale a Linear Input:-

Do This	The Display You Should See	Additional Notes
1. Select Conf as described in Chapter 2. Then press to select 'INPUT'		Scrolling display 'PROCESS INPUT LIST'
2. Press to scroll to 'IN. TYP'		Scrolling display 'INPUT TYPE'
3. Press or to 'mV'		
4. Press to scroll to 'M V . HI'		Scrolling display 'LINEAR INPUT HIGH'
5. Press or to '20.00'		
6. Press to scroll to 'M V . LO'		Scrolling display 'LINEAR INPUT LOW'
7. Press or to '4.00'		
8. Press to scroll to 'RNG . HI'		In operator level the controller will read 500.0 for a mV input of 20.00
9. Press or to '500.0'		Scrolling display 'RANGE HIGH LIMIT'
10. Press to scroll to 'RNG . LO'		In operator level the controller will read 2.0 for a mV input of 4.00
11. Press or to '2.0'		Scrolling display 'RANGE LOW LIMIT'

5. Input/Output

This section refers to Digital Inputs, Current Transformer Input and Relay/Logic Outputs.

The availability of these is shown in the following table:-

Name	Availability		Output	Input	Output Function	I/O Sense	Beacon (lit when active)	Terminal
	3116	3216						
I/O-1	✓	✓	✓	✓	Heat Cool Alarm	Normal Inverted	OP1	1A, 1B
OP-2	✓	✓	✓		Heat Cool Alarm	Normal Inverted	OP2	2A, 2B
AA Relay (OP4)		✓	✓		Heat Cool Alarm	Normal Inverted	OP4	AA, AB, AC
LA		✓		✓		Normal Inverted		C, LA
CT		✓		✓				C, CT
Digital Comms		✓						HD, HE, HF

5.1 Input/Output Parameters

5.1.1 Input/Output 1 List (IO-1)

Input/Output 1. May be configured to accept a digital input from external switch contacts or relay or logic output to plant devices. Connections are made to terminals 1A and 1B. OP1 beacon is operated from the IO-1 channel when it is configured as an output.

INPUT/OUTPUT LIST 1 'IO -1'							
Name	Scrolling Display	Parameter Description	Value			Default	Access Level
<i>I.I.D</i>	I/O 1 TYPE	I/O channel 1 hardware type defined by the hardware fitted	<i>nonE</i> <i>REL</i> <i>Lo</i> <i>DCOP</i>	No IO Relay OP Logic Input/Output DC Output (3216 only)		As ordered	Read only
<i>I.FUNC</i>	I/O 1 FUNCTION	I/O channel function	<i>nonE</i> <i>dout</i> <i>HEAT</i> <i>Cool</i> <i>dIn</i>	Disabled. If disabled no further parameters are shown Digital OP Heat OP Cool OP Digital IP if ' <i>I.I.D</i> ' = ' <i>LoP</i> '		<i>HEAT</i>	Conf
<i>I.SRC.A</i>	I/O 1 SOURCE A	These parameters only appear when the channel function is a Digital OP, i.e. <i>I.FUNC</i> = <i>dout</i> Selects an event status to be connected to the output channel. The output status is the result of an OR of Src A, Src B, Src C, and Src D Up to four events can, therefore, operate the output See section 5.1.4	<i>nonE</i>	No event connected to the output		<i>nonE</i>	Conf
<i>I.SRC.B</i>	I/O 1 SOURCE B		<i>AL1*</i>	Alarm 1	* Shows <i>Hi</i> , <i>Lo</i> , <i>dHi</i> , <i>dLo</i> , <i>brd</i> if the alarm type is configured		
<i>I.SRC.C</i>	I/O 1 SOURCE C		<i>AL2*</i>	Alarm 2			
<i>I.SRC.D</i>	I/O 1 SOURCE D		<i>AL3*</i>	Alarm 3			
			<i>AL4*</i>	Alarm 4			
			<i>ALLA</i>	All alarms			
			<i>nwAL</i>	Any new alarm			
			<i>CTAL</i>	CT alarm, load, leak & overcurrent			
			<i>Lbr</i>	Loop break alarm			
			<i>Sbr</i>	Sensor break alarm			
			<i>tEnd</i>	Timer end status			
			<i>tRun</i>	Timer run status			
			<i>mAn</i>	Manual status			
		<i>rmfF</i>	Remote fail - see section 5.1.2.				
		<i>PwrF</i>	Power fail. See section 5.1.5				
		<i>rEc</i>	Selects recipe 1 or 2				
<i>I.D.#</i>	DIGITAL INPUT FUNCTION	This parameter is only applicable to I/O 1 and only appears if the channel function is a Digital IP i.e. <i>I.FUNC</i> = <i>dIn</i> Only one function may be activated by a physical input	<i>nonE</i> <i>AcAL</i> <i>SP2</i> <i>Loc.b</i> <i>tRES</i> <i>tRun</i> <i>tRRS</i> <i>tHld</i> <i>mAn</i>	Input not used Alarm acknowledge Setpoint 2 select Front keypad disable (keylock) Timer reset Timer run Timer run/reset. Make to run, break to reset Timer hold Manual status		<i>AcAL</i>	Conf

			<i>Sby</i>	Standby mode. In this mode control outputs go to zero demand		
			<i>rmt</i>	To allow a remote setpoint to be selected through the IO1 digital input		
<i>I.PLS</i>	OUTPUT 1 MINIMUM PULSE TIME	Minimum output on/off time. Only applies to time proportioning outputs and prevents relays from switching too rapidly	0.0 to 150.0	Auto or 1.0 to 150.0 seconds Auto = 110mS	5.0 sec for relay Auto for logic	Conf
<i>I.SENS</i>	I/O 1 SENSE	To configure the polarity of the input or output channel	<i>nor</i> <i>inu</i>	Normal Inverted	See also section 5.1.3. See also section 5.1.3.	<i>nor</i> Conf if module enabled

5.1.2 Remote Setpoint Select and Remote Fail

These parameters were added in version 1.11 and are associated with the retransmission of remote setpoint through master comms (see section 11.2.1). 'rmt' allows the remote setpoint to be selected via a digital input and 'rmt.F' is a flag which is set if no comms activity is detected for 5 seconds or more when writing to the remote setpoint. The flag is reset when writing to the remote setpoint resumes.

5.1.3 Sense

If the module is an output, 'normal' means a relay output is energised for 100% PID demand. For a heating or cooling output, set this parameter to '*nor*'.

'Inverted' means a relay output is energised for 0% PID demand

For an alarm output set this parameter to '*inu*' so that it de-energises to the alarm state.

If the module is an input, 'normal' means the function is activated when the input contact is closed, and 'inverted' means the function is activated when the input contact is open.

5.1.4 Source



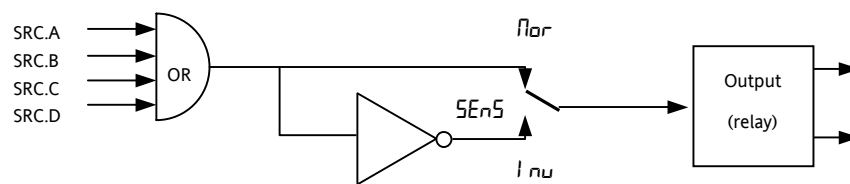

















The four parameters SOURCE A, SOURCE B, SOURCE C, and SOURCE D appear when the output is configured as a digital output i.e. '*-FUNC*' = '*digit*' and provide the facility to connect up to four alarms or events to operate a single output (normally configured as a relay). If any one of the events becomes true then the output relay will operate.



5.1.5 Power Fail

An output, configured as a digital output, can be made to operate following a power fail. It can be acknowledged in the same manner as an alarm but no alarm message is given.

5.1.6 Example: To Configure IO-1 Relay to Operate on Alarms 1 and 2:-

Do This	The Display You Should See	Additional Notes
1. From any display, press  as many times as necessary to select 'I O - 1'		Scrolling display 'I O - 1 LIST'
2. Press  to scroll to 'I I B'		This is the identification of the hardware fitted and cannot be adjusted
3. Press  to scroll to 'I F U N C'		The output must be configured for a relay or digital I/O Scrolling display 'I O I FUNCTION'
4. Press  or  to select 'dout'		In normal operation the output will activate if either alarm 1 or alarm 2 occur Scrolling display 'I O I SOURCE A'
5. Press  to scroll to 'I S R C . A'		Scrolling display 'I O I SOURCE B' Continue to select up to four events if required using I.SR.C.A and I.SR.C.B
6. Press  or  to select the event which you want to operate the output, eg 'AL. 1'		'Inverted' means a relay output is energised for 0% PID demand 'Normal' means a relay output is energised for 100% PID demand Scrolling display 'I O I SENSE'
7. If a second event is required to operate the same output, press  to select 'I S R C . B'		
8. Press  or  to select the second event which you want to operate the output, eg 'AL. 2'		
9. Press  to scroll to 'I S E N S'		
10. Press  or  to select 'I nu'		

5.1.7 Output List 2 (OP-2)

This is an optional normally open relay or logic output and is available on terminals 2A and 2B. The way in which this output operates is determined by parameters in the OP- 2 List. OP2 beacon is operated from the IO- 2 output channel.

OUTPUT LIST 2 'OP-2'						
Name	Scrolling Display	Parameter Description	Value		Default	Access Level
2.1	OUTPUT 2 TYPE	Output channel 2 hardware type	none rELY LOG dCOP	Output not fitted Relay OP Logic output (3216 only) DC Output (3216 only)	As ordered	Read only
2.FUNC	FUNCTION	Output channel 2 function	none dout HEAT COOL	Disabled. If disabled no further parameters are shown Digital OP Heat OP Cool OP	dout	Conf
2.SRC.A	I/O 2 SOURCE A	These parameters only appear when the channel function is a Digital OP, i.e. 2.FUNC = dout	none	No event connected to the output	none	Conf
2.SRC.B	I/O 2 SOURCE B		AL1*	Alarm 1		
2.SRC.C	I/O 2 SOURCE C	AL2*	Alarm 2			
		AL3*	Alarm 3			
		AL4*	Alarm4			
2.SRC.D	I/O 2 SOURCE D	The output status is the result of an OR of Src A, Src B, Src C, and Src D Up to four events can, therefore, operate the output See section 5.1.3.	ALLA	All alarms		
			nwAL	Any new alarm		
			CTAL	CT alarm, load, leak & overcurrent		
			Lbr	Loop break alarm		
			Sbr	Sensor break alarm		
			tEnd	Timer end status		
			tRun	Timer run status		
			mAn	Manual status		
		rmtF	Remote fail - see section 5.1.2.			
		PwrF	Power fail. See section 5.1.5			
2.PLS	OUTPUT MINIMUM PULSE TIME	Minimum output on/off time. Only applies to time proportioning outputs and prevents relays from switching too rapidly	0.0 to 150.0	Auto or 1.0 to 150.0 seconds Auto = 110mS	5.0 sec for relay Auto for logic	Conf
2.SENS	SENSE	To configure the polarity of output channel 2	nor inu	Normal See also section 5.1.3. Inverted See also section 5.1.3..	nor	Conf if module enabled

* The mnemonic for the alarm will change depending upon the alarm configuration.

5.1.8 AA Relay (AA)

This is a changeover relay and is optionally available in 3216 controllers. It is not available in 3116 controllers. Connections are made to terminals AA, AB, and AC. The way in which this relay operates is determined by parameters in the AA List. OP4 beacon is operated from the AA relay output channel.

AA RELAY 'RR'							
Name	Scrolling Display	Parameter Description	Value		Default	Access Level	
4.TYPE	OUTPUT 4 TYPE	Output channel 4 hardware type	<i>rELY</i>	Relay OP		Read only	
4.FUNC	FUNCTION	Output channel 4 function	<i>nonE</i> <i>dOUT</i> <i>HEAT</i> <i>COOL</i>	Disabled Digital OP Heat OP Cool OP	<i>dOUT</i>	Conf	
4.SRC.A	I/O 4 SOURCE A	These parameters only appear when the channel function is a Digital OP, i.e. 4.FUNC = <i>dOUT</i> Selects an event status to be connected to the output channel. The output status is the result of an OR of Src A, Src B, Src C, and Src D Up to four events can, therefore, operate the output See section 5.1.3.	<i>nonE</i>	No event connected to the output		<i>nonE</i>	Conf
4.SRC.B	I/O 4 SOURCE B		<i>AL1*</i>	Alarm 1	* Shows <i>Hi</i> , <i>Lo</i> , <i>dHi</i> , <i>dLo</i> , <i>bnd</i> if the alarm type is configured		
4.SRC.C	I/O 4 SOURCE C		<i>AL2*</i>	Alarm 2			
			<i>AL3*</i>	Alarm 3			
			<i>AL4*</i>	Alarm4			
4.SRC.D	I/O 4 SOURCE D		<i>ALLA</i>	All alarms			
			<i>nwAL</i>	Any new alarm			
			<i>CTAL</i>	CT alarm, load, leak & overcurrent			
			<i>Lbr</i>	Loop break alarm			
			<i>Sbr</i>	Sensor break alarm			
		<i>tEnd</i>	Timer end status				
		<i>tRun</i>	Timer run status				
		<i>mAn</i>	Manual status				
		<i>rmtF</i>	Remote fail - see section 5.1.2.				
		<i>PwrF</i>	Power fail. See section 5.1.5				
4.PLS	OUTPUT MINIMUM PULSE TIME	Minimum output on/off time. Only applies to time proportioning outputs and prevents relays from switching too rapidly	0.0 to 150.0	0 to 150 seconds	5.0 sec	Conf	
4.SENS	SENSE	To configure the polarity of output channel 4	<i>nor</i> <i>Inv</i>	Normal See also section 5.1.3. Inverted See also section 5.1.3.	<i>nor</i>	Conf if module enabled	

* The mnemonic for the alarm will change depending upon the alarm configuration.

5.1.9 Logic Input Parameters

Input A. This is a digital input wired to terminals C and LA and available in 3216 only. The input is typically from a voltage free contact, which can be configured to operate a number of functions as determined by parameters in the LA List.

Note: Terminal C is common to the CT input and is, therefore, not isolated from the CT.

LOGIC INPUT LIST 'LR'						
Name	Scrolling Display	Parameter Description	Value		Default	Access Level
<i>L.TYPE</i>	LOGIC INPUT TYPE	Input channel type	<i>LJP</i>	Logic input	As order code	Conf Read only
<i>L.D.#</i>	LOGIC INPUT FUNCTION	To configure the function of the digital input	<i>nonE</i>	Input not used	<i>AcAL</i>	Conf
			<i>AcAL</i>	Alarm acknowledge		
			<i>SP2</i>	Setpoint 2 select		
			<i>Loc.b</i>	Front keypad disable		
			<i>tRES</i>	Timer reset		
			<i>tRun</i>	Timer run		
			<i>tRRS</i>	Timer run/reset. Make to run, break to reset		
			<i>tHld</i>	Timer hold		
			<i>mAn</i>	Manual status		
			<i>Sby</i>	Standby mode. In this mode control outputs go to zero demand		
			<i>rmt</i>	To allow a remote setpoint to be selected through the LA digital input		
<i>rEc</i>	Selects recipe 1 or 2					
<i>L.SENS</i>	LOGIC INPUT SENSE	To configure the polarity of the input channel	<i>nor</i> <i>Inv</i>	Normal Inverted	<i>nor</i>	Conf

5.2 Current Transformer Input Parameters

The 3216 controller can measure, via an external current transformer, the current flowing through the electrical load when the heat output is 'on' (load current) and also when it is 'off' (leakage current). This input is not applicable to 3116 controllers.

Alarm If the load current is lower than a threshold limit or the leakage current is higher than a threshold limit, then an alarm triggers. The hysteresis to exit from either of these alarm conditions is fixed at 2% of the current transformer span.

Full scale value Selectable from 10 to 1000A

CURRENT TRANSFORMER LIST 'CT-IMP'						
Name	Scrolling Display	Parameter Description	Value		Default	Access Level
CTID	MODULE TYPE	CT module identity	CTn	CT input circuit fitted	As order code	Conf read only
CTSRC	CT SOURCE	Selects the output controlling the current measured by the CT input. The source can only be selected if the output has been configured for Heat or Cool	none IO-1 OP-2 AA	None Input/output 1 Output 2 AA Relay		
CTRNG	CT RANGE	Sets the CT inputs range	0 to CT full scale value (1000)		As order code	Conf
CTLAT	CT ALARM LATCH TYPE	To configure the latch mode of the CT input alarm. A description of alarm latching is given in the alarm section	none Auto man	No latching Latched with automatic reset Latched with manual reset	no	Conf if CT alarm enabled
LDALM	LOAD CURRENT THRESHOLD	Load open circuit alarm threshold – low alarm	OFF to CT full scale value (settable to 3000)			Read only
LKALM	LEAK CURRENT THRESHOLD	Leakage current in the off state alarm threshold – high alarm	OFF to CT full scale value (settable to 3000)			Read only
HCALM	OVER CURRENT THRESHOLD	Overcurrent threshold – high alarm	OFF to CT full scale value (settable to 3000)			
LDAMP	LOAD CURRENT	Measured load current				L3 if CT input enabled
LKAMP	LEAK CURRENT	CT input leakage current				L3 if CT input enabled

5.2.1 Analogue Representation of Current Alarms

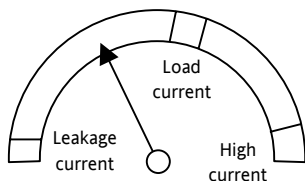

5.2.2 Current Transformer Wiring Diagram

This diagram shows an example of wiring for a CT input.

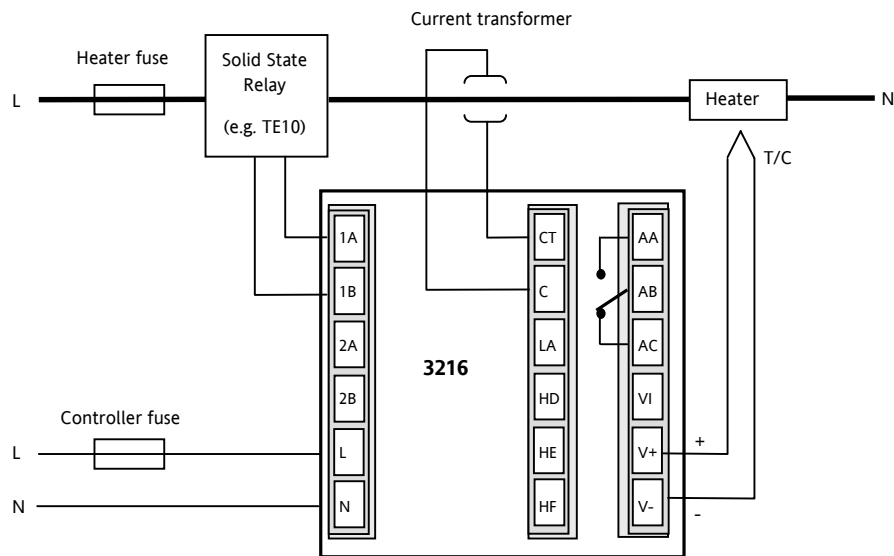

Note: the burden resistor value 10Ω is mounted inside the controller. It is recommended that the current transformer is fitted with a voltage limiting device such as two back to back zener diodes between 3 and 10V and rated for 50mA.

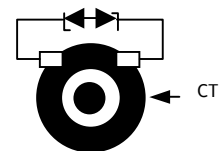

6. Setpoint Generator

The setpoint generator provides the target value at which it is required to control the process. It is shown in the controller block diagram, Section 3. The following functions are available:-











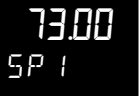

Number of setpoints	Two, SP1 and SP2. Each may be selected by a dedicated parameter or externally switched via a digital input suitably configured as described in section 6.1. An application example might be to use SP1 for normal operation and SP2 to maintain a low overnight temperature.
Setpoint limits	High and low limits can be pre-set to prevent inadvertent adjustment of the setpoint beyond that allowable for the process
Set point rate limit	Allows the setpoint to change from its current level to a new level at a fixed rate.
Direct setpoint access	The selected setpoint is accessible directly from the HOME display by pressing the raise or lower buttons

6.1 Setpoint Parameters

SETPOINT LIST 'SP'						
Name	Scrolling Display	Parameter Description	Value		Default	Access Level
<i>SP.SEL</i>	SETPOINT SELECT	This enables the main or secondary setpoint to be selected from the front panel buttons	<i>SP1</i> <i>SP2</i>	Setpoint 1 selected Setpoint 2 selected	<i>SP1</i>	L3
<i>SP1</i>	SETPOINT 1	Main or normally selected setpoint	Low to high setpoint limits		<i>0</i>	L3
<i>SP2</i>	SETPOINT 2	Secondary or standby setpoint	Low to high setpoint limits		<i>0</i>	L3
<i>SP.HI</i>	SETPOINT HIGH LIMIT	Maximum allowable setpoint setting	Setpoint low limit (SP.LO) to high range limit. Also limited by the <i>RNG.HI</i> and <i>RNG.LO</i> parameters		Range High Limit	L3
<i>SP.LO</i>	SETPOINT LOW LIMIT	Minimum allowable setpoint setting	Low range limit to Setpoint high limit (SP.HI). Also limited by the <i>RNG.HI</i> and <i>RNG.LO</i> parameters		Range Low Limit	L3
<i>RM.SP</i>	REMOTE SETPOINT	Value of the remote setpoint over comms. If no value received within 5 seconds fallback is to local setpoint				Read only
<i>LR</i>	REMOTE SETPOINT SELECT	To select the remote setpoint	<i>no</i> <i>YES</i>	Not selected Selected	<i>no</i>	Conf
<i>SP.RAT</i>	SETPOINT RATE LIMIT	Limits the rate of change of the setpoint. Operates on both SP1 and SP2	Step change (<i>OFF</i>) to <i>3000</i> display units per minute. Resolution one decimal place more than PV		<i>OFF</i>	L3
<i>RAMP.U</i>	SETPOINT RAMP UNITS	To set the units for the setpoint rate limit	<i>min</i> <i>Hour</i> <i>SEC</i>	Minutes Hours Seconds	<i>min</i>	L3
<i>LOC.T</i>	LOCAL SETPOINT TRIM	To apply a fixed offset to the remote setpoint in use	-199.9 to 300.0		<i>0.0</i>	L3

6.2 Example: To Set Ramp Rate

This is available in Level 3.

Do This	The Display You Should See	Additional Notes
1. Press  as many times as necessary to select 'SETPOINT LIST'		
2. Press  as many times as necessary to scroll to 'SP 1'		This step can be repeated for the lower setpoint limit 'SP.L0'
3. Press  or  to adjust setpoint 1		
4. Press  to scroll to 'SP 2'		
5. Press  or  to adjust setpoint 2		
6. Press  as many times as necessary to scroll to 'SP.RAT'		Whenever the setpoint is changed, the controller will ramp from its current setpoint to the new value at the rate set in units per second, minute or hours as set by the 'RAMPU' parameter.
7. Press  or  to set the rate at which you require the setpoint to change		It will also change at the same rate when switching between SP2 and SP1 (but not between SP1 and SP2) The setpoint rate resolution is generally one decimal point more than setpoint/PV resolution

7. Control

Parameters in this section allow the control loop to be set up for optimum control conditions. An example of a temperature control loop is shown below:-

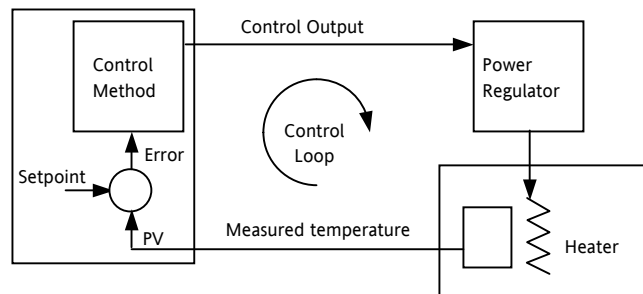

The actual temperature measured at the process (PV) is connected to the input of the controller. This is compared with a setpoint (or required) temperature (SP). If there is an error between the set and measured temperature the controller calculates an output value to call for heating or cooling. The calculation depends on the process being controlled but normally uses a PID algorithm. The output(s) from the controller are connected to devices on the plant which cause the heating (or cooling) demand to be adjusted which in turn is detected by the temperature sensor. This is referred to as the control loop or closed loop control.

7.1 PID Control

The PID controller consists of the following parameters:-

Parameter	Meaning or Function
Proportional Band	The proportional term, in display units or %, delivers an output which is proportional to the size of the error signal.
Integral Time	Removes steady state control offsets by ramping the output up or down in proportion to the amplitude and duration of the error signal.
Derivative Time	Determines how strongly the controller will react to the rate of change in the measured value. It is used to prevent overshoot and undershoot and to restore the PV rapidly if there is a sudden change in demand.
High Cutback	The number of display units, above setpoint, at which the controller will increase the output power, in order to prevent undershoot on cool down.
Low Cutback	The number of display units, below setpoint, at which the controller will cutback the output power, in order to prevent overshoot on heat up.
Relative Cool Gain	Only present if cooling has been configured. Sets the cooling proportional band, which equals the heat proportional band value divided by the cool gain value.

7.2 Tuning

In tuning, you match the characteristics (PID parameters) of the controller to those of the process being controlled in order to obtain good control. Good control means:

Stable, 'straight-line' control of the PV at setpoint without fluctuation

No overshoot, or undershoot, of the PV setpoint

Quick response to deviations from the setpoint caused by external disturbances, thereby rapidly restoring the PV to the setpoint value.

Tuning involves calculating and setting the value of the parameters listed in the above table.

7.2.1 Automatic Tuning

This controller uses a one-shot tuner which automatically sets up the initial values of the parameters listed in the table on the previous page.

7.2.2 One-shot Tuning

The 'one-shot' tuner works by switching the output on and off to induce an oscillation in the measured value. From the amplitude and period of the oscillation, it calculates the tuning parameter values.

If the process cannot tolerate full heating or cooling being applied, then the levels can be restricted by setting the high power limit ('*Q P . H I*') and low power limit ('*Q P . L O*'). However, the measured value *must* oscillate to some degree for the tuner to be able to calculate values.

A One-shot Tune can be performed at any time, but normally it is performed only once during the initial commissioning of the process. However, if the process under control subsequently becomes unstable (because its characteristics have changed), you can re-tune again for the new conditions.

It is best to start tuning with the process at ambient conditions and with the SP close to the normal operating level. This allows the tuner to calculate more accurately the low cutback and high cutback values which restrict the amount of overshoot, or undershoot.

Typical automatic tuning cycle

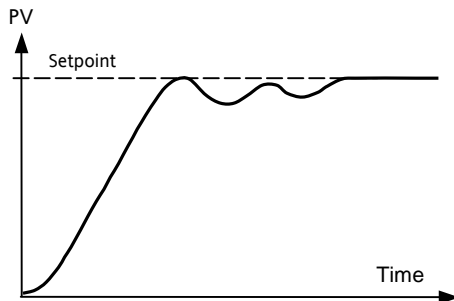

Autotune starts 1 minute after being turned on to determine steady state conditions.

Tuning normally takes place at a PV which has a value of setpoint x 0.7.

The power is automatically turned on and off to cause oscillations.

From the results the values shown in the table are calculated

7.2.3 Calculation of the cutback values

Low cutback and *High cutback* are values that restrict the amount of overshoot, or undershoot, that occurs during large step changes in PV (for example, under start-up conditions).

If either low cutback, or high cutback, is set to 'Auto' the values are fixed at three times the proportional band, and are not changed during automatic tuning.

To tune the cutback values, first set them to values other than Auto, then perform a tune as usual.

7.2.4 Manual Tuning

If for any reason automatic tuning gives unsatisfactory results, you can tune the controller manually. There are a number of standard methods for manual tuning. The one described here is the Ziegler-Nichols method.

With the process at its normal running conditions:

Set the Integral Time and the Derivative Time to OFF.

Set High Cutback and Low Cutback to 'Auto'.

Ignore the fact that the PV may not settle precisely at the setpoint.

If the PV is stable, reduce the proportional band so that the PV just starts to oscillate. If PV is already oscillating, increase the proportional band until it just stops oscillating. Allow enough time between each adjustment for the loop to stabilise. Make a note of the proportional band value 'P' and the period of oscillation 'T'.

Set the proportional band, integral time and derivative time parameter values according to the calculations given in the table below:-

Type of control	Proportional band (P)	Integral time (I) seconds	Derivative time (D) seconds
Proportional only	2xB	OFF	OFF
P + I control	2.2xB	0.8xT	OFF
P + I + D control	1.7xB	0.5xT	0.12xT

7.2.5 Setting the Cutback Values

The above procedure sets up the parameters for optimum steady state control. If unacceptable levels of overshoot or undershoot occur during start-up, or for large step changes in PV, then manually set the cutback parameters.

Proceed as follows:

Set the low and high cutback values to three proportional bandwidths (that is to say, $C.B.H.I = C.B.L.O = 3 \times P.B$).

Note the level of overshoot, or undershoot, that occurs for large PV changes (see the diagrams below).

In example (a) increase Low Cutback by the undershoot value. In example (b) reduce Low Cutback by the overshoot value.

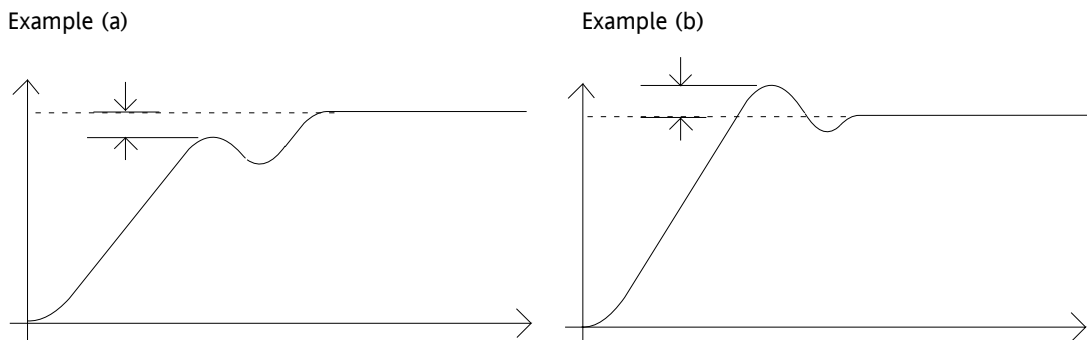

Where the PV approaches setpoint from above, you can set High Cutback in a similar manner.

7.3 Integral Action and Manual Reset

In a full three-term controller (that is, a PID controller), the integral term automatically removes steady state errors from the setpoint. If the controller is set as a P or PD controller, the integral term will be set to 'OFF'. Under these conditions the measured value may not settle precisely at setpoint. The Manual Reset parameter ($M R$) represents the value of the power output that will be delivered when the error is zero. You must set this value manually in order to remove the steady state error.

7.4 Relative Cool Gain

The proportional band parameter ' $P B$ ' adjusts the proportional band for the heating output. Relative cool gain adjusts the cooling proportional band relative to the heating proportional band. If the rate of heating and rate of cooling are widely different it may be necessary to manually adjust Relative Cool Gain to achieve the optimum settings for the cooling proportional band.

(This parameter is set automatically when Autotune is used). A nominal setting of around 4 is often used.

7.5 Control Action

When set to reverse ($R E V$) the output increases when the PV is below setpoint. This is the best setting for heating control.

For cooling control only set to direct ($D I R$).

7.6 On/Off Control

On/Off control simply turns heating power on when the temperature is below setpoint and off when it is above setpoint. If cooling is used, cooling power is turned on when the temperature is above setpoint and off when it is below. The outputs of such a controller will normally be connected to relays – hysteresis may be set in the same way as described in the Alarms section to prevent relay chatter or to provide a delay in the control output action.

7.7 Loop Break Time

The loop is considered to be broken if the PV does not respond to a change in the output. Since the time of response will vary from process to process the Loop Break Time parameter allows a time to be set before a loop break alarm is initiated. In these circumstances the output power will drive to high or low limit. For a PID controller, if the PV has not moved by $0.5 \times P_b$ in the loop break time the loop is considered to be in break. The loop break time is set by the AutoTune, a typical value is $12 \times T_d$. For an On/Off controller LBT is not shown and loop break alarm is inhibited.

7.8 Cooling Algorithm

The method of cooling may vary from application to application.

For example, an extruder barrel may be cooled by forced air (from a fan), or by circulating water or oil around a jacket. The cooling effect will be different depending on the method. The cooling algorithm may be set to linear where the controller output changes linearly with the PID demand signal, or it may be set to water, oil or fan where the output changes non-linearly against the PID demand. The algorithm provides optimum performance for these methods of cooling.

7.9 Control Parameters

The following table shows the parameters available.

CONTROL LIST		'CTRL'			
Parameter Name	Parameter Description (Scrolling Display)	Value		Default	Access Level
CTRL.H	HEATING TYPE	PID OFF ONOFF	PID Heating off On/Off	As order code	Conf
CTRL.C	COOLING TYPE	OFF PID ONOFF	Cooling disable PID On/Off	OFF	Conf
CTRL.A	CONTROL ACTION	REV DIR	Reverse acting. Output decreases as PV increases Direct acting. Output increases as PV decreases	REV	Conf
PB.UNT	PROPORTIONAL BAND UNITS	ENG PERC	In engineering units In percent		
RTUNE	AUTO-TUNE ENABLE	OFF ON	Autotune off Set to 'on' to start auto-tuning	OFF	L3
PB	PROPORTIONAL BAND	0.1 to 9999 display units or 1 to 999.9% if proportional band expressed as %		20	L3
TI	INTEGRAL TIME	Off to 9999 seconds		360 sec	L3
TD	DERIVATIVE TIME	Off to 9999 seconds		60 sec	L3
R2G	RELATIVE COOL GAIN See also section 7.4	0.1 to 10.0		1.0	L3
CBHI	CUTBACK HIGH See also section 7.2.5.	Auto or 1 to 3000 display units		Auto = 3xPb	L3
CBLO	CUTBACK LOW See also section 7.2.5.	Auto or 1 to 3000 display units		Auto = 3xPb	L3
MR	MANUAL RESET	0 to 100% (heat only) -100.0 to 100.0% (heat/cool)		0.0%	L3
LBT	LOOP BREAK TIME	OFF or 1 to 9999 minutes			
OP.HI	OUTPUT HIGH	±100% Adjust to limit the maximum heating power applied to the process		100.0%	L3
OP.LO	OUTPUT LOW	±100% Adjust to limit the maximum cooling power applied to the process or to apply a minimum heating power		0.0%	L3
DBAND	CHANNEL 2 DEAD BAND Period when no output is demanded from either channel 1 or channel 2 Adjust, for example, to increase the period when no heating or cooling power is applied	OFF or 0.1 to 100.0% of the cooling proportional band		OFF	L3
HYS.T.H	HEATING HYSTERESIS	-199.9 to 200.0 display units		1	L3

<i>H Y S T . C</i>	COOLING HYSTERESIS	-199.9 to 200.0 display units		1	On/off only
<i>S A F E</i>	SAFE OUTPUT POWER	To set the output level in a sensor break (open circuit) condition		0 to 100%	0%
<i>C O O L T</i>	NON-LINEAR COOLING TYPE This selects an algorithm most suited to the type of cooling. Typically used in extruders.	<i>L i n</i> <i>O i l</i> <i>H 2 O</i> <i>F A n</i>	Linear Oil cooling Water cooling Forced air cooling		
<i>R -M</i>	LOOP MODE – AUTO MANUAL OFF see also section 1.10.4.	<i>A u t o</i> <i>m A n</i> <i>O F F</i>	To select automatic operation To select manual operation Control outputs inhibited		
<i>L B R</i>	LOOP BREAK STATUS	<i>N o</i> <i>Y E S</i>	Shows the current status of loop break.		Read only

7.9.1 Effect of Control Action, Hysteresis and Deadband

For temperature control 'CONTROL ACTION' will be set to 'rEΛ'. For a PID controller this means that the heater power decreases as the PV increases. For an on/off controller output 1 (usually heat) will be on (100%) when PV is below the setpoint and output 2 (usually cool) will be on when PV is above the setpoint

Hysteresis applies to on/off control only. It defines the difference in temperature between the output switching off and switching back on again. The examples below shows the effect in a heat/cool controller.





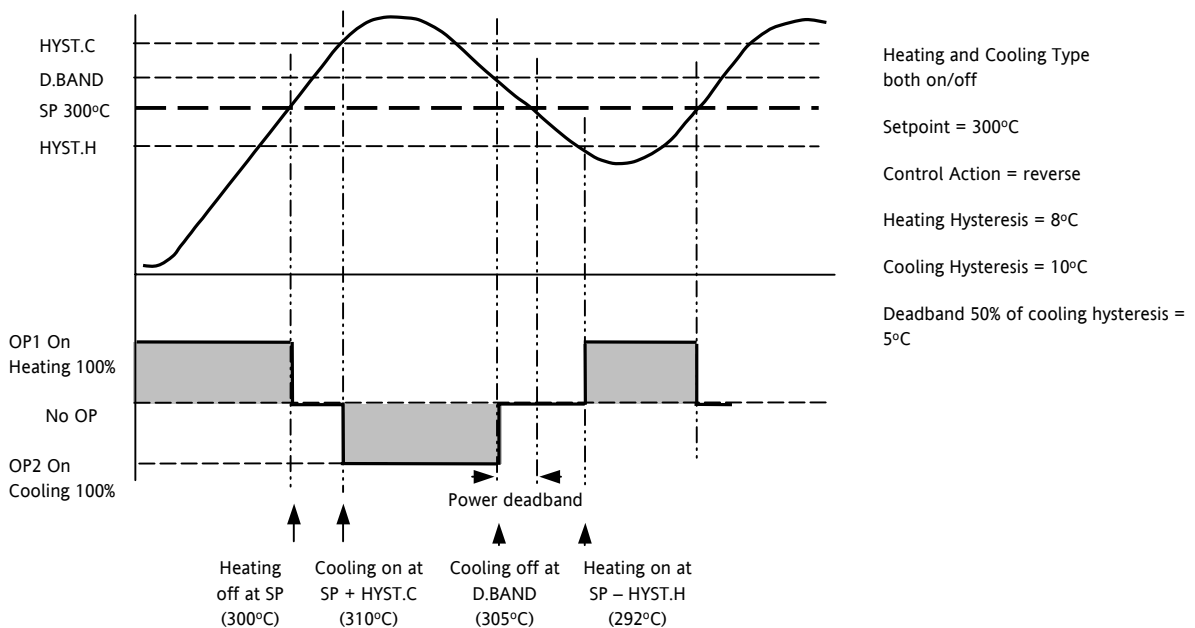
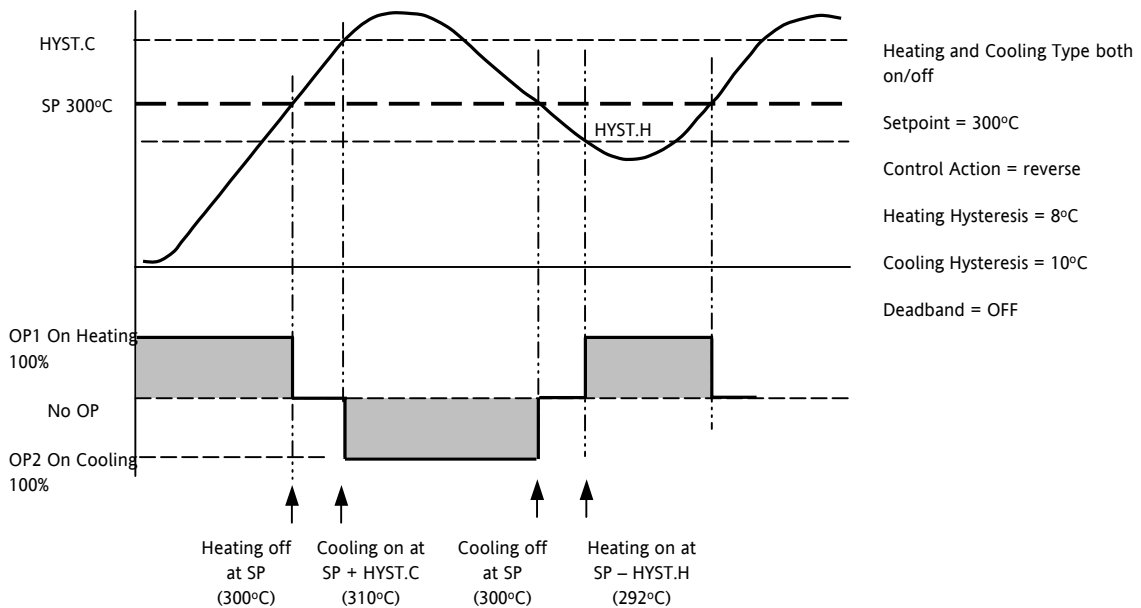

















Deadband can operate on both on/off control or PID control where it has the effect of widening the period when no heating or cooling is applied. However, in PID control its effect is modified by both the integral and derivative terms. Deadband might be used in PID control, for example, where actuators take time to complete their cycle thus ensuring that heating and cooling are not being applied at the same time. Deadband is likely to be used, therefore, in on/off control only. The second example below adds a deadband of 20 to the above example.

In an on/off controller, if CONTROL ACTION = rev then OP2 will be on when PV is below SP. OP1 will be on when the PV is above SP. The outputs are, therefore, reversed in the above example.



7.10 Example: To Configure Heating and Cooling

Enter configuration level as described. Then:-

Do This	The Display You Should See	Additional Notes
1. Press  as many times as necessary to select 'CTRL'		
2. Press  to scroll to 'CTRLH' 3. Press  or  to select the Heating Type		Heating Type choices are:- <i>Pi d</i> PID (3 term) control <i>on.oF</i> On/Off control <i>oFF</i> No heating output configured
4. Press  to select 'CTRL.C' 5. Press  or  to select the Cooling Type		Cooling Type choices are:- <i>oFF</i> No cooling output configured <i>Pi d</i> PID (3 term) control <i>on.oF</i> On/Off control
6. Press  to select 'CTRL.A' 7. Press  or  to 'rEu'		Control Action choices are:- <i>rEu</i> Reverse - heating control <i>di r</i> Direct - cooling only control
8. Press  to scroll to 'P.B.UNIT' 9. Press  or  to choose units		Proportional Band Units choices are:- <i>EnG</i> Engineering units <i>PERc</i> Percentage
10. Continue to select parameters using  for example 'O.P.HI' 11. Press  or  to change their values		When PID control is selected, this places a limit on the output demand from the PID which can be applied to the heating circuit. 'O.P.LB' can be set up in the same way if required. If on/off control is selected these parameters do not apply. They are replaced by 'HYST.H' and 'HYST.L' to set the difference between the output switching off to switching on.

8. Alarms

Alarms are used to alert an operator when a pre-set level has been exceeded. They are indicated by a scrolling message on the display and the red ALM beacon. They may also switch an output– usually a relay (see section 8.1.1) – to allow external devices to be operated when an alarm occurs. Alarms only operate if they have been ordered and configured.

Up to eight different alarms are available:-

- Alarm 1: configurable as full scale high or low, band or deviation high or low
- Alarm 2: configurable as full scale high or low, band or deviation high or low
- Alarm 3: configurable as full scale high or low, band or deviation high or low
- Alarm 4: configurable as full scale high or low, band or deviation high or low
- Sensor Fault alarm
- Loop Break alarm
- Current Transformer alarms – Leak, Load Fail, Overcurrent
- Remote Fail Alarm
- Power Fail Indication

Events are indication only but can operate an output. They can also be configured, using the editing tool (iTools), to provide scrolling text messages on the display.

8.1 Types of Alarm Used in the 3200 Controller

This section shows graphically the operation of different types of alarm used in the controller. The graphs show changes in PV plotted against time. (Hysteresis set to zero)

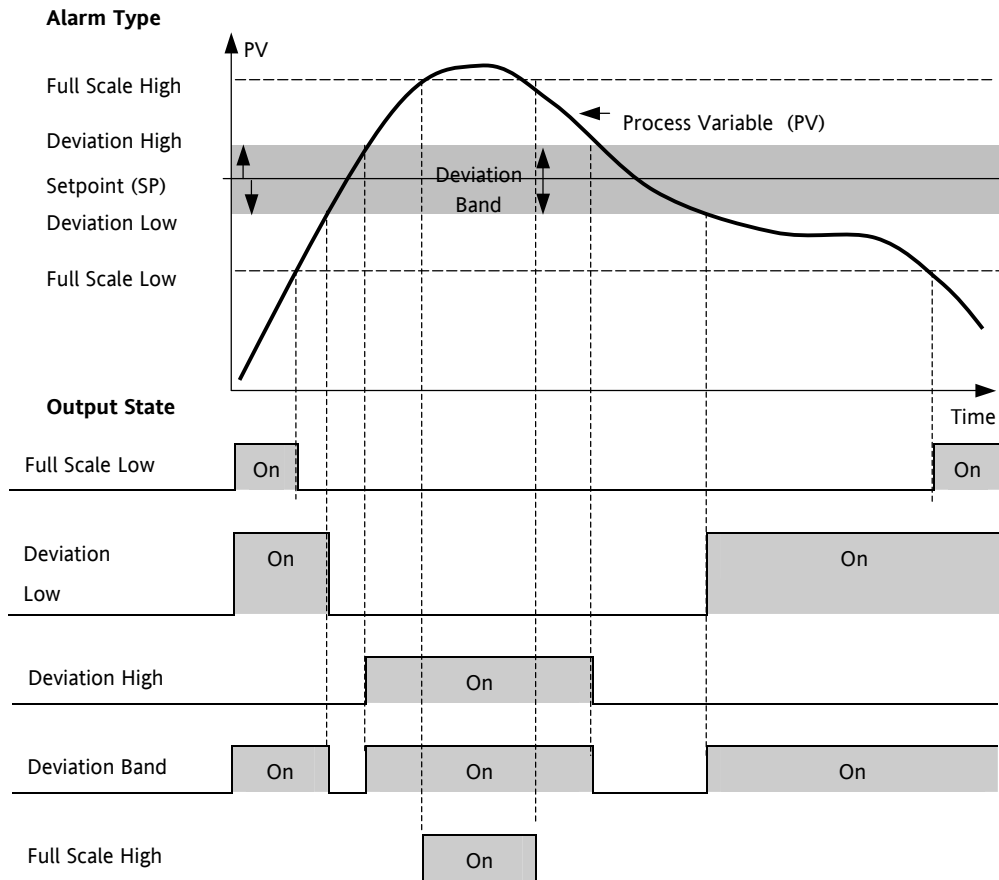

Hysteresis is the difference between the point at which the alarm switches 'ON' and the point at which it switches 'OFF'. It is used to provide a definite indication of the alarm condition and to prevent alarm relay chatter.

Latching Alarm is used to hold the alarm condition once an alarm has been detected. It may be configured as:-

- nonE* Non latching A non latching alarm will reset itself when the alarm condition is removed
- Auto* Automatic An auto latching alarm requires acknowledgement before it is reset. The acknowledgement can occur **BEFORE** the condition causing the alarm is removed.
- mAn* Manual The alarm continues to be active until both the alarm condition is removed AND the alarm is acknowledged. The acknowledgement can only occur **AFTER** the condition causing the alarm is removed.
- Evt* Event ALM beacon does not light but an output associated with this parameter will activate and a scrolling message will appear if this has been configured.

Blocking Alarms The alarm may be masked during start up. Blocking prevents the alarm from being activated until the process has first achieved a safe state. It is used to ignore start up conditions which are not representative of running conditions.

A blocking alarm is re-initiated after a setpoint change.

See section 8.2 for an explanation of the behaviour of blocking alarms under different conditions.

8.1.1 Alarm Relay Output

Alarms can operate a specific output (usually a relay). Any individual alarm can operate an individual output or any combination of alarms, up to four, can operate an individual output. They are either supplied pre-configured in accordance with the ordering code or set up in configuration level.

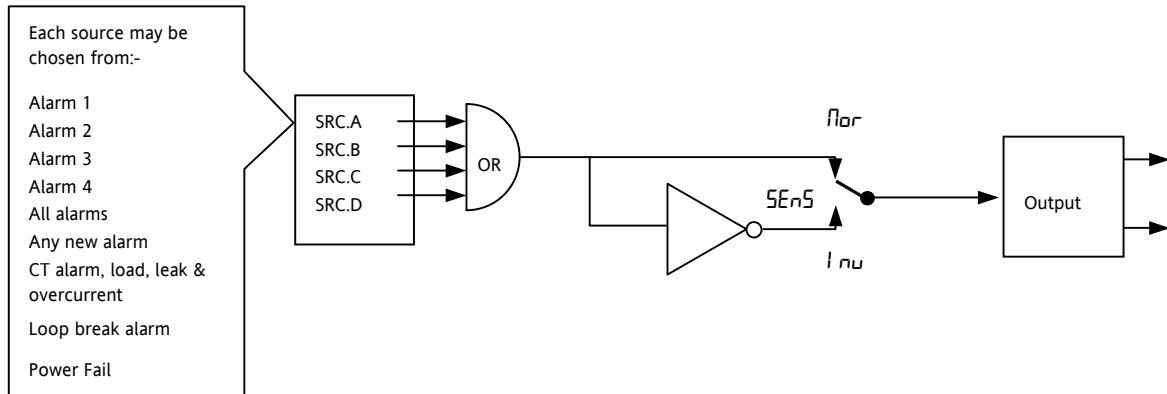

8.1.2 Alarm Indication

- ALM beacon flashing red = a new alarm (unacknowledged)
- This is accompanied by a scrolling alarm message. A typical default message will show the source of the alarm followed by the type of alarm. For example, 'ALARM 1 FULL SCALE HIGH'
- Using Eurotherm iTools configuration package, it is also possible to download customised alarm messages. An example might be, 'PROCESS TOO HOT', see section 13.4.
- If more than one alarm is present further messages are flashed in turn in the main display. The alarm indication will continue while the alarm condition is present and is not acknowledged.
- ALM beacon on continuously = alarm has been acknowledged

8.1.3 To Acknowledge An Alarm

Press  and  together.

The action, which now takes place, will depend on the type of latching, which has been configured

Non Latched Alarms

Alarm condition present when the alarm is acknowledged.

- ALM beacon on continuously.
- The alarm message(s) will continue to scroll

This state will continue for as long as the alarm condition remains. When the alarm condition disappears all indication also disappears.

If a relay has been attached to the alarm output, it will de-energise when the alarm condition occurs and remain in this condition until acknowledged or the alarm is no longer present.

If the alarm condition disappears before it is acknowledged the alarm resets immediately.

Latched Alarms

See description in section 8.1.

8.2 Behaviour of Alarms After a Power Cycle

The response of an alarm after a power cycle depends upon the latching methodology, whether it has been configured to be a blocking alarm, its state and the acknowledge status of the alarm.

The response of active alarms after a power cycle is as follows:

For a non-latching alarm or an event alarm blocking will be re-instated, if configured. If blocking is not configured the active alarm will remain active. If the alarm condition has gone safe during the down time the alarm will return inactive.

For an auto-latching alarm blocking will be re-instated, if configured, only if the alarm had been acknowledged prior to the power cycle. If blocking is not configured or the alarm had not been acknowledged the active alarm will remain active. If the alarm condition has gone safe during the downtime the alarm will return inactive if it had been acknowledged prior to the power cycle else it will return safe but not acknowledged. If the alarm was safe but not acknowledged prior to the power cycle the alarm will return safe but not acknowledged.

For a manual-latching alarm blocking will not be re-instated and the active alarm will remain active. If the alarm condition has gone safe during the downtime the alarm will return safe but not acknowledged. If the alarm was safe but not acknowledged prior to the power cycle the alarm will return safe but not acknowledged.

The following examples show graphically the behaviour under different conditions:-

8.2.1 Example 1

Alarm configured as Absolute Low; Blocking: No Latching

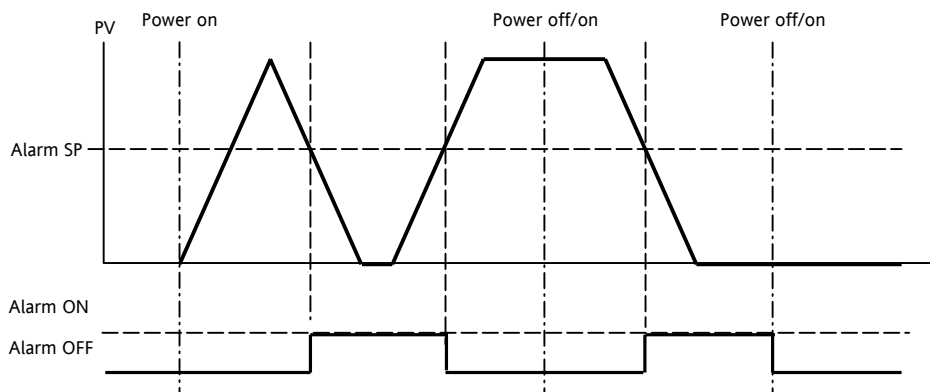

8.2.2 Example 2

Alarm configured as Absolute Low; Blocking: Manual Latching

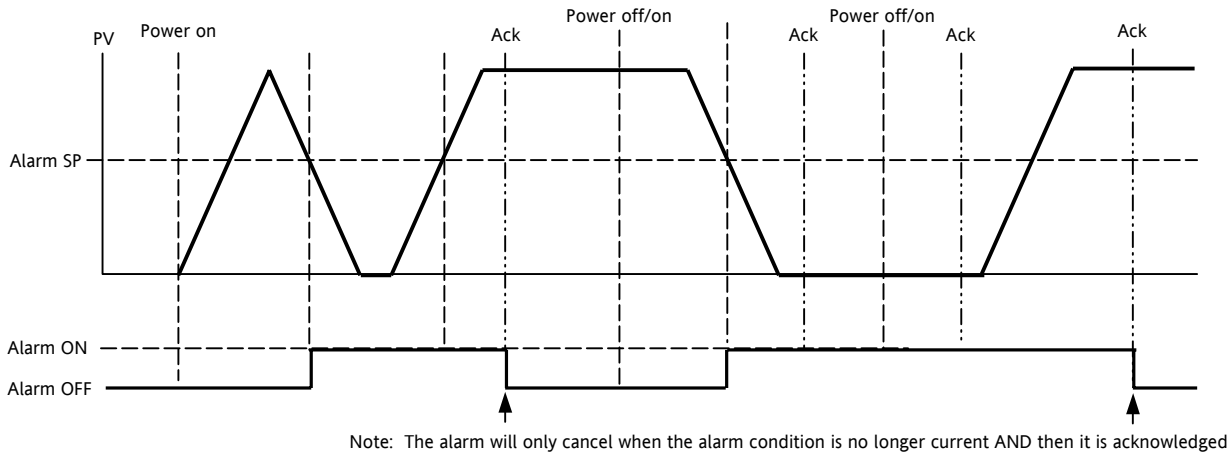

8.2.3 Example 3

Alarm configured as Absolute Low; Blocking: Auto Latching

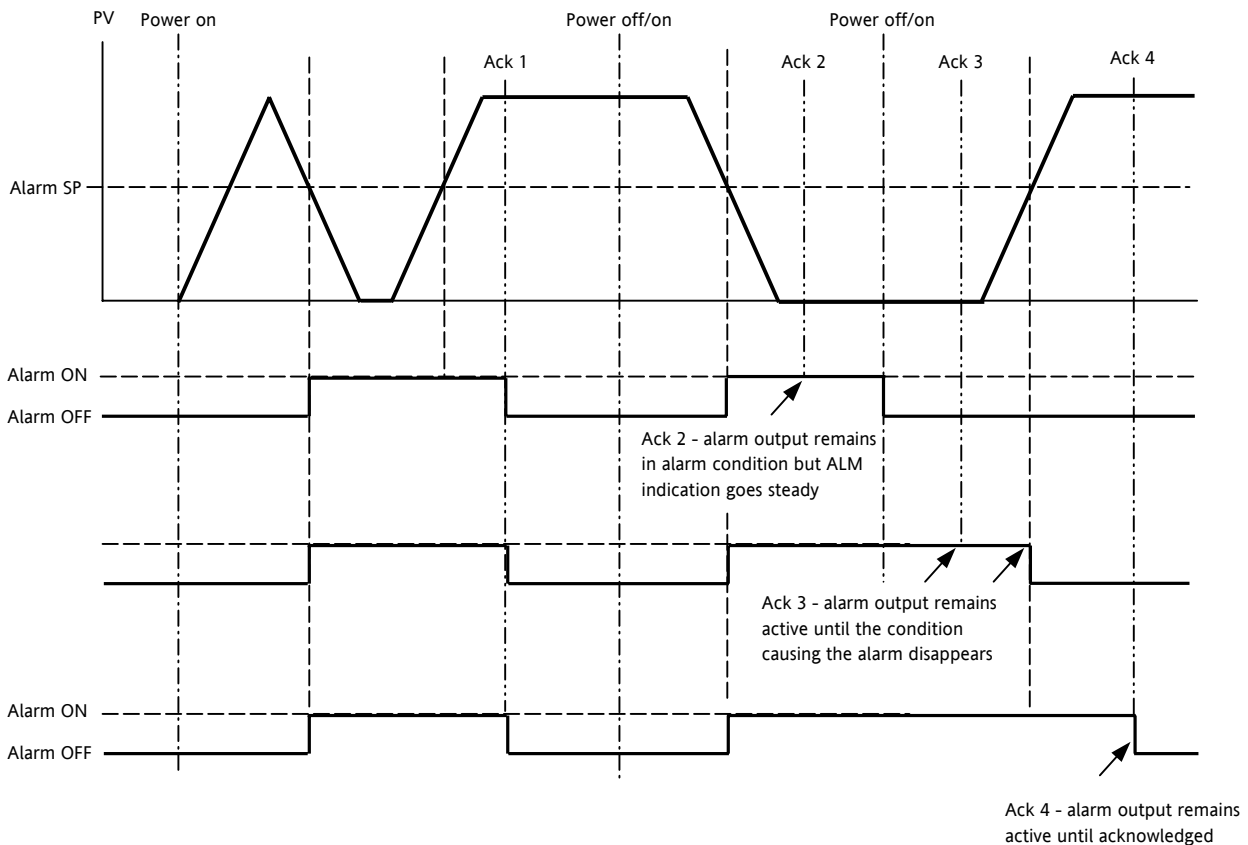

























8.3 Alarm Parameters

Four alarms are available. Parameters do not appear if the Alarm Type = None. The following table shows the parameters to set up and configure alarms.

ALARM LIST 'ALARM'						
Name	Scrolling Display	Parameter Description	Value		Default	Access Level
AL1TYP	ALARM 1 TYPE	Selects the type of alarm	nonE	Alarm not configured	As order code	Conf
			Hi	Full Scale High		
			Lo	Full Scale Low		
			dHi	Deviation High		
			dLo	Deviation Low		
			bnd	Deviation band		
AL1SET	ALARM 1 SETPOINT	Alarm 1 threshold value. The last three characters show the type of alarm configured from the above list	Instrument range		0	L3
AL1STS	ALARM 1 OUTPUT	Indicates the status of the alarm output	OFF	Alarm output deactivated		
			On	Alarm output activated		
AL1HYS	ALARM 1 HYSTERESIS	See description at the beginning of this section	0 to 9999			Conf
AL1LAT	ALARM 1 LATCHING TYPE	See description at the beginning of this section	nonE	Non latching	As order code	Conf
			Auto	Automatic		
			man	Manual		
			Evt	Event (no alarm flashing beacon but messages can be displayed)		
AL1BLK	ALARM 1 BLOCKING	See description at the beginning of this section	No	No blocking	No	Conf
			YES	Blocking		
The above parameters are repeated for Alarm 2, AL2; Alarm 3, AL3; Alarm 4, AL4						

8.3.1 Example: To Configure Alarm 1

Enter configuration level as described. Then:-

Do This	The Display You Should See	Additional Notes
1. Press  as many times as necessary to select 'ALARM'		
2. Press  to select 'AL.TYP' 3. Press  or  to select the required alarm type		Alarm Type choices are:- <i>nonE</i> Alarm not configured <i>Hi</i> Full Scale High <i>Lo</i> Full Scale Low <i>dHi</i> Deviation High <i>dLo</i> Deviation Low <i>bnd</i> Deviation Band
4. Press  to select 'AL.---' 5. Press  or  to set the alarm trip level		This is the alarm threshold setting for. The last three characters (---) will show the type of alarm configured from the above list. The alarm threshold is shown in the upper display. In this example the high alarm will be detected when the measured value exceeds 215
6. Press  to select 'ALISTS'		This is a read only parameter which shows the status of the alarm output
7. Press  to select 'AL.HYS' 8. Press  or  to set the hysteresis		In this example the alarm will cancel when the measured value decreases 2 units below the trip level (at 213 units)
9. Press  to select 'AL.LAT' 10. Press  or  to select the latching type		Latching Type choices are:- <i>nonE</i> No latching <i>Auto</i> Automatic <i>man</i> Manual <i>Evt</i> Event See the introduction to the alarm section for an explanation
11. Press  to select 'AL.BLK' 12. Press  or  to 'YES' or 'No' 13. Repeat the above to configure alarms 2, 3 and 4 if required		

8.4 Diagnostic Alarms

Diagnostic alarms indicate a possible fault within the controller or connected devices.

Display shows	What it means	What to do about it
<i>ECONF</i>	A change made to a parameter takes a finite time to be entered. If the power to the controller is turned off before the change has been entered then this alarm will occur. Do not turn the power off to the controller while <i>ECONF</i> is flashing	Enter configuration mode then return to the required operating mode. It may be necessary to re-enter the parameter change since it will not have been entered in the previous configuration.
<i>EEAL</i>	Calibration error	Re-instate Factory calibration
<i>EEEr</i>	EEPROM error	Return to factory for repair
<i>EEEr</i>	Non-vol memory error	Note the error and contact your supplier
<i>ELIn</i>	Invalid input type. This refers to custom linearisation which may not have been applied correctly or may have been corrupted.	Go to the INPUT list in configuration level and set a valid thermocouple or input type

9. Timer

A timer can be configured to operate in four different modes. These can be selected in Level 3 or configuration level.

1. Dwell timer
2. Delayed switch on timer
3. Soft start timer
4. Programmer if this has been ordered

There are four operating states:

1. **Run.** This starts the timer
2. **Hold.** This stops the timer at the elapsed time. It will start again from the elapsed time when Run is selected again.
3. **Reset.** This sets the timer back to zero. It can be run again from this state.
4. **End** cannot be set - it occurs automatically when the timer has counted down to zero

Run, Hold and Reset may be set through the front panel or by the following methods:-

- Edge trigger a suitably configured digital input
- Power cycle the controller
- Digital communications command
- Selecting 'T.STAT' from the parameter list

Switching from Hold to Run through the front panel buttons is not allowable if the Hold status is forced by a logic input or through Digital Communications.

9.1.1 Timer Beacon

Timer operation is indicated by a beacon labelled RUN:

RUN beacon	Timer Status	Default Message
Off	Reset	
On	Run	TIMER RUNNING
Flashing	Hold	TIMER HOLD
Off	End	TIMER END

9.1.2 Logic outputs

The timer may be configured to operate an output when it is running or during the end state

Note:-

- **Power up** - the 'run' state is selected if a Soft Start or Delay timer is configured or the 'Reset' state is selected if a Dwell timer is configured.
- **Auto/Manual** is only available when the timer is in Reset. Selection of Auto/Manual/Off mode may be inhibited by configuring the Keylock parameter in the Access List to 'tmr'.
- **Ramp Rate** – it is recommended that ramp rate is used only with a Dwell type timer

Quick access to the timer operating parameters is available in Level 2 by pressing . Repeat pressing of this button shows Timer Status, Dwell, Working Output, SP1, SP2, etc

9.1.3 Power Cycling

If the power is turned off when the timer is running it will come back on as follows:-

For a Dwell type timer it will come back on in Reset

For a Delayed Switch on timer or a Soft Start timer, the controller will come back on in the Run condition and start again from the beginning.

9.2 Dwell Timer

A dwell timer is used to control a process at a fixed temperature for a defined period.

The action which occurs at the end of the timed period depends on the configuration of other parameters and will be described in the following pages.

9.2.1 Example: End Type (End.T) = OFF Setpoint 1 (SP1) = 70°C

If the End Type is configured as OFF, the controller outputs go to zero at the end of the period.

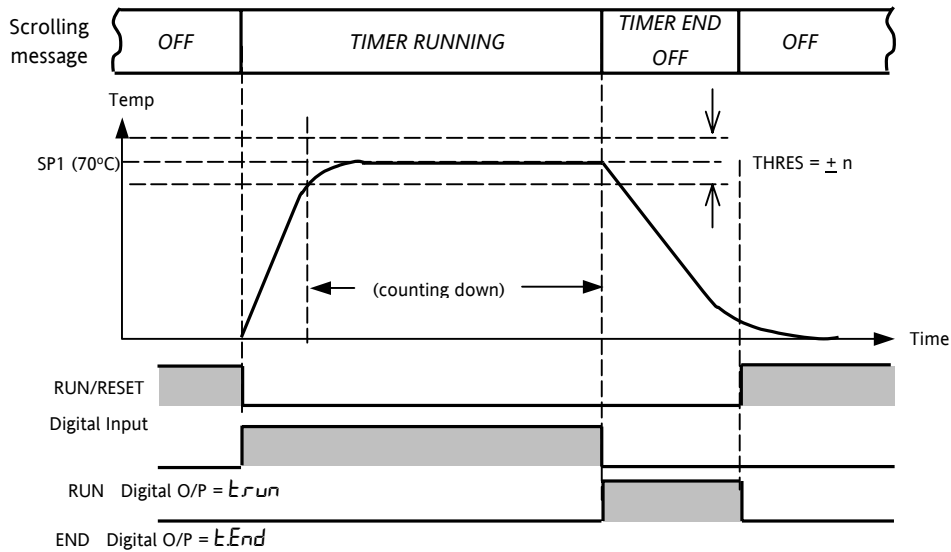
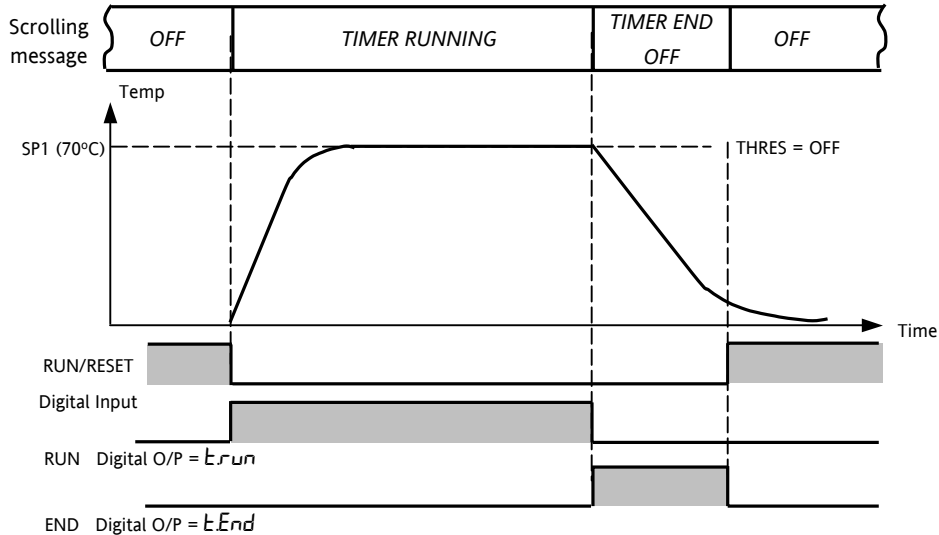

Notes:

1. If THRES = 2° (for example) timer will display the message 'TIMER RUNNING' and RUN beacon will be on but will not start counting down until temp is initially within 2° of SP
2. The DWELL period can be reduced or increased when the timer is running. If it is reduced to meet the Time Elapsed the timer will change to the End state. .
3. A-M can only be selected when in reset
4. If the timer is re-configured to a different type or the End Type is re-configured (a dwell, for example), it is necessary to press \blacktriangle and \blacktriangledown together to enter Auto/Manual mode. Then press \blacktriangle to change from OFF mode to Auto. The timer can then be re-run in its new configuration.

9.2.2 Example: End Type (End.T) = Dwell Setpoint 1 (SP1) = 70°C

If the End Type is configured as Dwell, control will continue at the end of the time period. An external device can be triggered when END is reached.

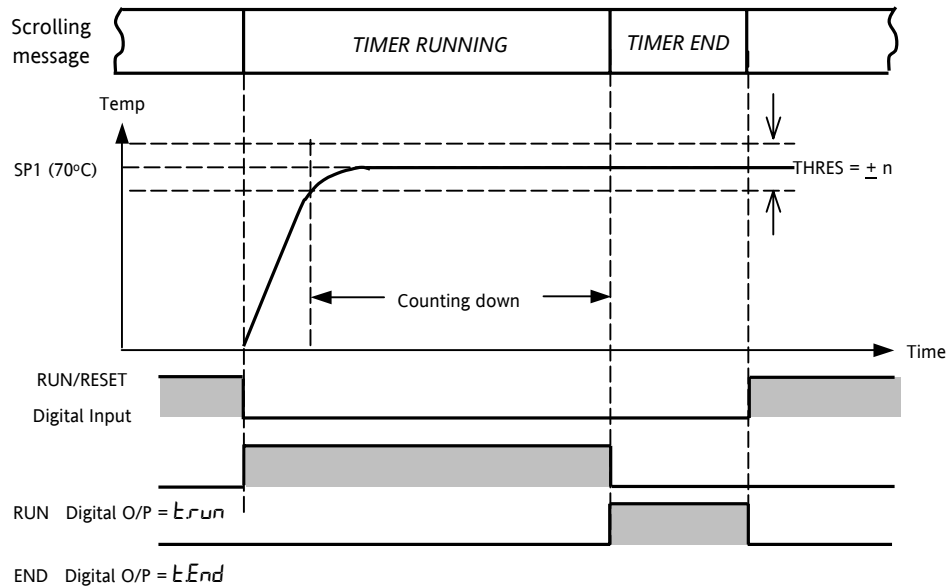
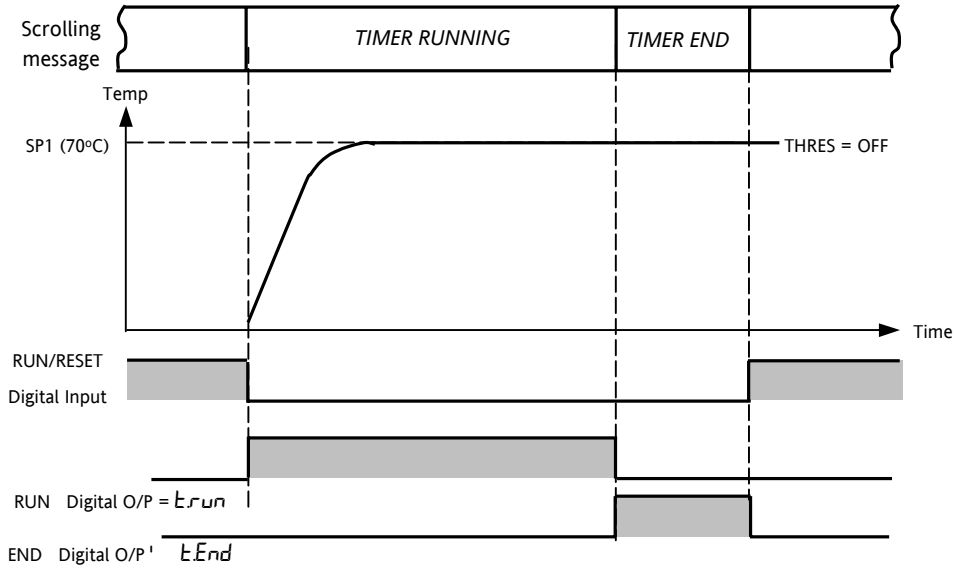

☺ The timer does not start to count down until the PV reaches the deviation set by the threshold value





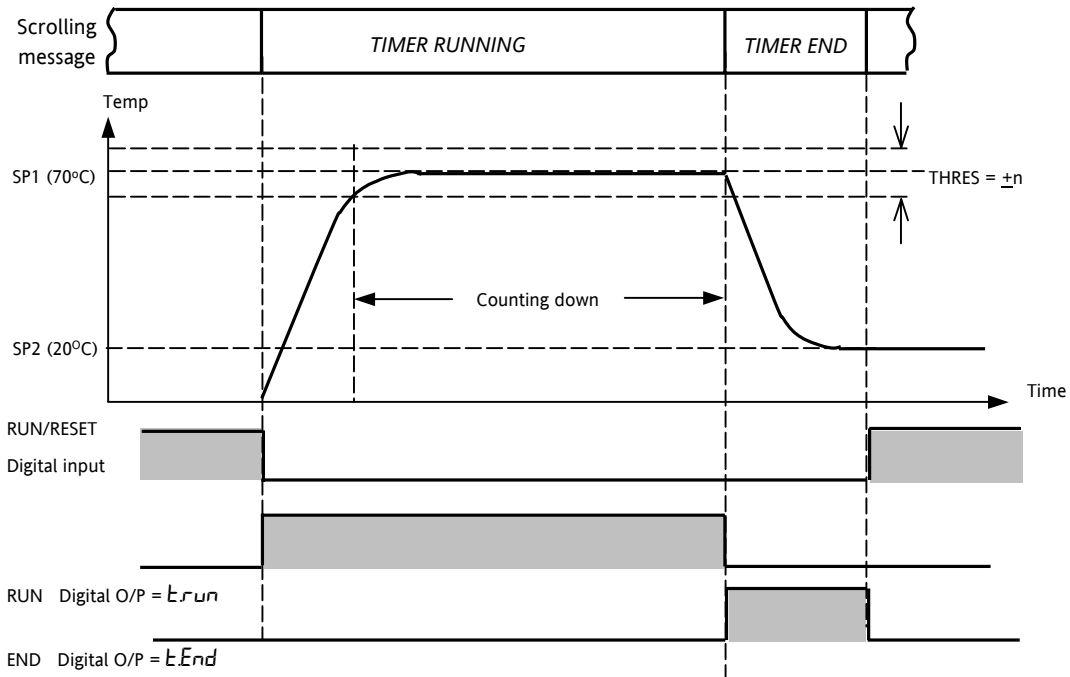
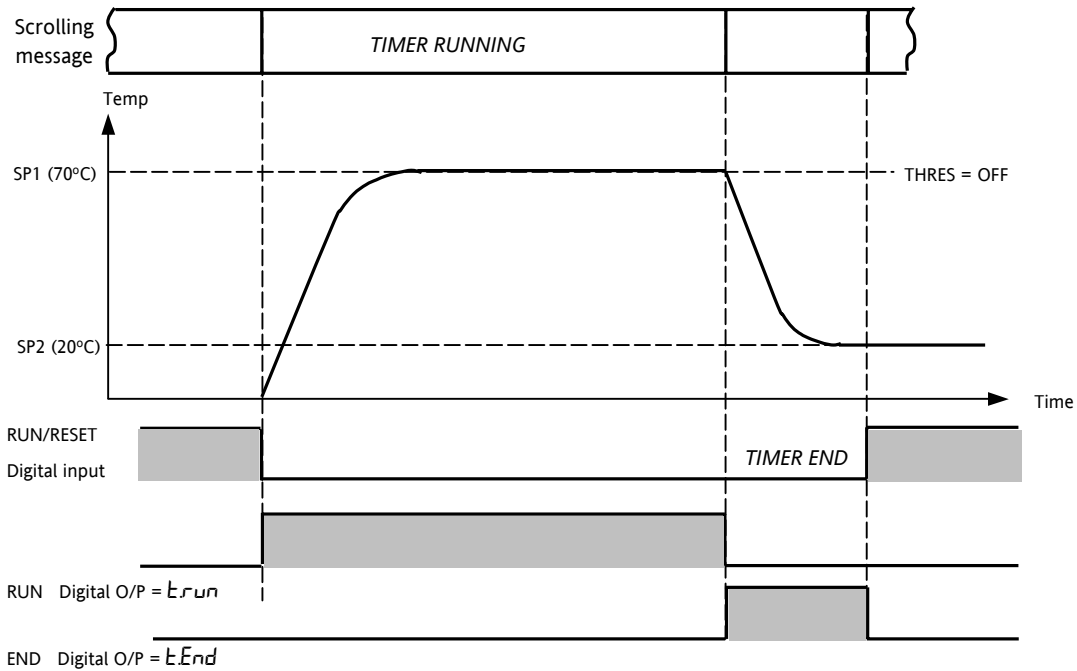



9.2.3 Example: End Type (End.T) = SP2 = 20°C Setpoint 1 (SP1) = 70°C

If the End Type is configured as SP2 the process will control at this setpoint at the end of the period.







☺ The timer does not start to count down until the PV reaches the deviation set by the threshold value

9.2.4 To Run a Dwell Type Timer

Do This	The Display You Should See	Additional Notes												
1. Momentarily press  and  together	  	<p>RUN beacon on</p> <p>Controller heating towards SP1 (70°C)</p> <p>Scrolling display 'TIMER RUNNING'</p> <p>↓</p> <p>When timed out. Scrolling display 'TIMER END'</p> <p>RUN beacon off</p> <p>The control action and display depend on the End Type:</p> <table border="1"> <thead> <tr> <th>End.T</th> <th>Control Action</th> <th>Display</th> </tr> </thead> <tbody> <tr> <td>OFF</td> <td>Control outputs at zero</td> <td>OFF</td> </tr> <tr> <td>Dwell</td> <td>Controlling as set by SP1</td> <td>Value of SP1 (70°C)</td> </tr> <tr> <td>SP2</td> <td>Controlling as set by SP2</td> <td>Value of SP2 (20°C) SPX beacon on</td> </tr> </tbody> </table> <p>The timer can be run again from this point</p>	End.T	Control Action	Display	OFF	Control outputs at zero	OFF	Dwell	Controlling as set by SP1	Value of SP1 (70°C)	SP2	Controlling as set by SP2	Value of SP2 (20°C) SPX beacon on
End.T	Control Action	Display												
OFF	Control outputs at zero	OFF												
Dwell	Controlling as set by SP1	Value of SP1 (70°C)												
SP2	Controlling as set by SP2	Value of SP2 (20°C) SPX beacon on												
2. Press  and  (Ack) together to reset the timer		<p>RUN beacon off</p> <p>TIMER END message cancelled</p> <p>The control action and display depend on the End Type as shown above</p> <p>The timer can be run again from this point</p>												

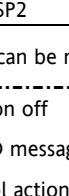

9.2.5 To Hold the Timer

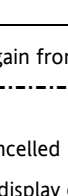
While the timer is running it can be put into Hold (timer stops counting down)



Do This	The Display You Should See	Additional Notes
3. Momentarily press  and  together		<p>RUN beacon flashing</p> <p>Scrolling display 'TIMER HOLD'</p> <p>Controller heating towards SP1 (70 °C)</p> <p>If End.T = OFF or Dwell the 'TIMER HOLD' message scrolls</p>
4. Momentarily press  and  together to run the timer from the hold condition		<p>RUN beacon on</p> <p>Scrolling display 'TIMER RUNNING'</p> <p>Controller continues heating towards SP1 (70 °C)</p>

9.2.6 To Reset the Timer

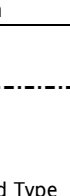
While the timer is running it can be Reset

Do This	The Display You Should See	Additional Notes
5. Press and hold  and  together		<p>The control action and display depend on the End Type as shown above</p> <p>If reset T.REMN and T.ELAP stay at their values prior to reset. These reset to their start values when the timer is run again</p>

9.2.7 Example: SP1 = 70°C End.T = SP2 = 20°C Ramp Rate (SP.RAT) = 20°C/min



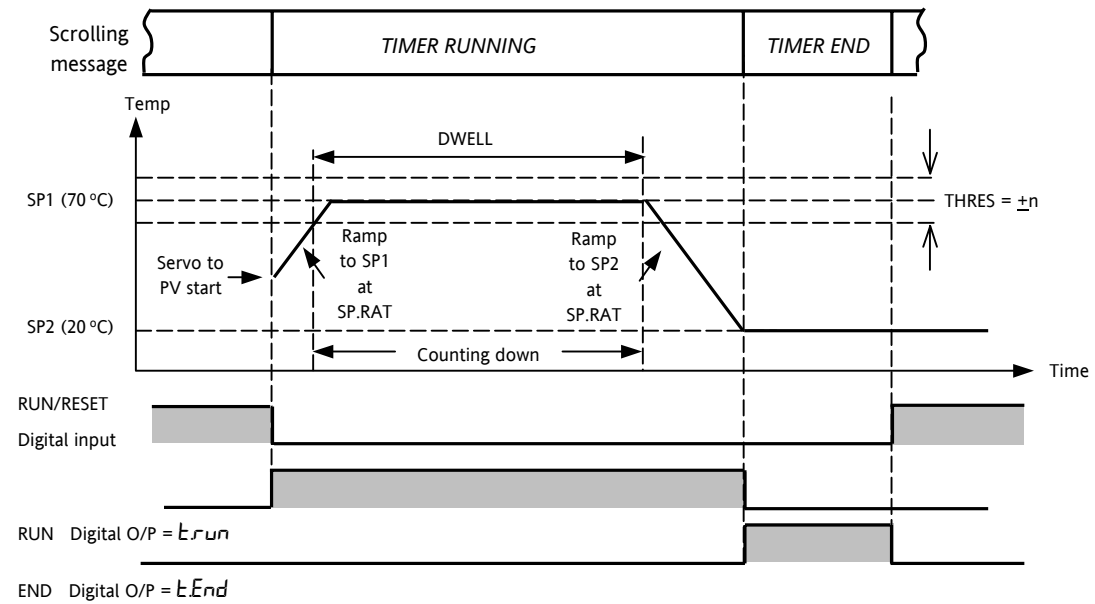
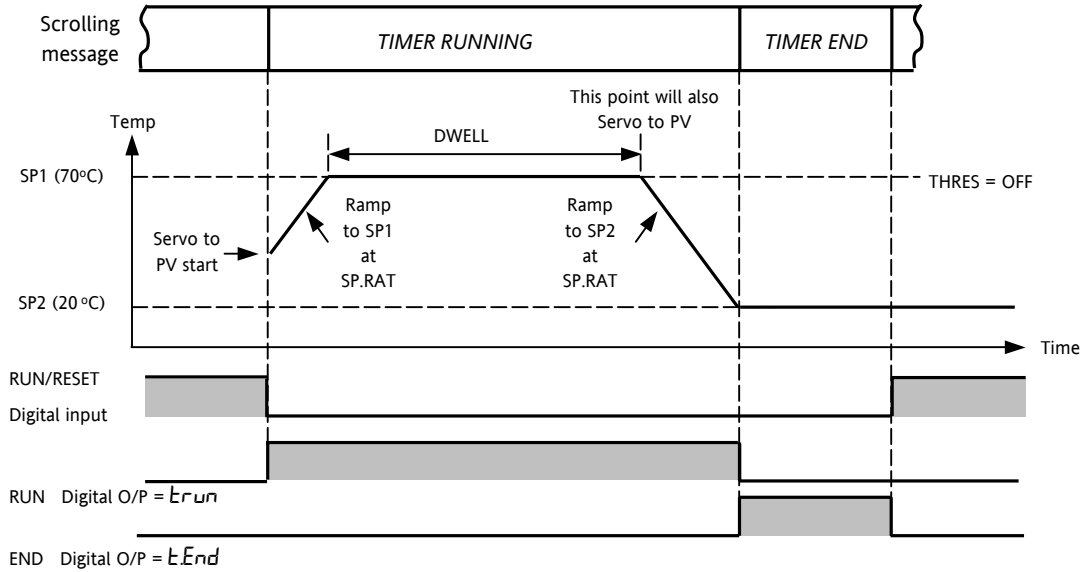





In this mode a ramp/dwell, ramp/dwell programmer is configured. The threshold value behaves like a holdback value and can be turned off. A digital output can be configured to operate an external buzzer, or other form of indication, to alert the operator to the end of the process. It is cancelled by pressing 'Ack'  and .



This now behaves as a simple four segment programmer of two ramps two dwells







9.2.8 To Run a Timer Configured as a Simple Programmer

At start of run controller servos to PV and, therefore, starts at the current temperature

Do This	The Display You Should See	Additional Notes
1. Momentarily press  and  together	  	<p>RUN beacon on</p> <p>Scrolling display 'TIMER RUNNING'</p> <p>Controller ramping up to SP1 (70°C) at the set rate (20/min max - for this example)</p> <p>When SP1 reached the controller will control at this temperature until the end of the DWELL period set. This is from the point at which the timer was set to run.</p> <p>To ensure the dwell starts from SP1 (or close to) set THRES = a small value (eg2)</p> <p>↓</p> <p>When timed out Scrolling display 'TIMER END' will be indicated</p> <p>Controller ramp to SP2 (20 °C) at the set rate (20 °C /min max - for this example)</p> <p>SPX beacon on</p>
2. Press  and  (Ack) together to reset the timer		<p>RUN beacon off</p> <p>Controller controlling at SP2 (20 °C)</p> <p>TIMER END message cancelled</p> <p>SPX beacon on (indicating control at SP2)</p> <p>The timer can be run again from this point</p>



9.2.9 To Hold the Timer

While the timer is running it can be put into Hold (timer stops counting down)

Do This	The Display You Should See	Additional Notes
3. Momentarily press  and  together		<p>RUN beacon flashing</p> <p>Scrolling display 'TIMER HOLD'</p> <p>Controller controlling at SP1 (70 °C)</p>
4. Momentarily press  and  together to run the timer from the hold condition		<p>RUN beacon on</p> <p>Scrolling display 'TIMER RUNNING'</p> <p>Controller continues controlling at SP1 (70 °C)</p>

9.2.10 To Reset the Timer

While the timer is running it can be Reset



Do This	The Display You Should See	Additional Notes
5. Press and hold  and  together		<p>When the timer is running it cannot be reset using the Ack button(s) since pressing these will return the display to the HOME display</p> <p>If reset T.REMN and T.ELAP stay at their values prior to reset. These reset to their start values when the timer is run again</p>

9.3 Delayed Switch On Timer

9.3.1 Example: Timer Cfg = Dely Setpoint 1 (SP1) = 70°C

The timer is used to switch on the controller output power after a fixed length of time. It could be used to turn on a process at a particular time.

It is initiated by any of the following:

- Switching on power
- Momentarily pressing  and  together
- Setting the parameter T.STAT to run
- A command through serial communications
- A logic input suitably configured





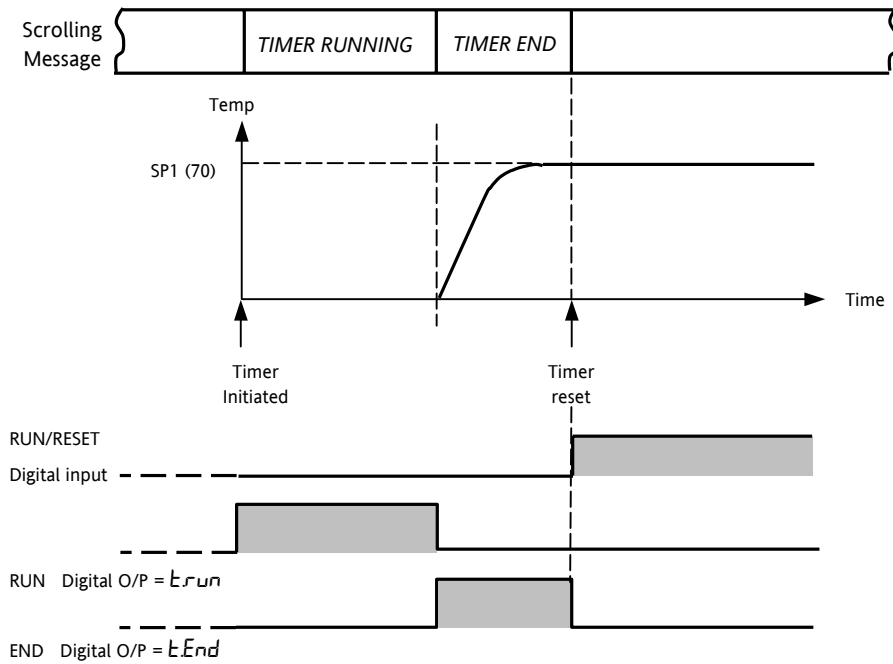

When the timer status = run, the control output is off

When the timer status = reset, the control output is controlling







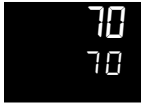

9.3.2 To Run a Delayed Switch-on Timer

At start of run controller switches to OFF mode.

Do This	The Display You Should See	Additional Notes
1. Momentarily press  and  together	 ↓ 	RUN beacon on Scrolling display alternates between 'T I M E R R U N N I N G' and 'E N D' ↓ Controller heating towards the setpoint (70°C) Scrolling display 'T I M E R E N D' When timed out TIMER END will be indicated RUN beacon off Any digital output configured as <i>tEnd</i> will operate Any digital output configured as <i>tRun</i> will cancel
2. Press  and  (Ack) together to reset the timer		Controller continues to control at setpoint (70°C) TIMER END message cancelled Any digital output configured as <i>tEnd</i> will cancel The timer can be run again from this point

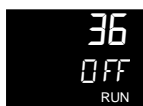

9.3.3 To Hold the Timer

While the timer is running it can be put into Hold (timer stops counting down)

Do This	The Display You Should See	Additional Notes
3. Momentarily press  and  together		RUN beacon flashing Scrolling display 'T I M E R H O L D' Controller not controlling It is possible to reset the timer when in hold by pressing and holding  and  or a digital input etc. It cannot be reset using Ack.
4. Momentarily press  and  together to run the timer from the hold condition		RUN beacon on Scrolling display 'T I M E R R U N N I N G' Controller controlling at setpoint (70°C)









9.3.4 To Reset the Timer

While the timer is running it can be Reset

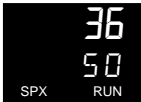
Do This	The Display You Should See	Additional Notes
5. Press and hold  and  together		If reset T.REMN and T.ELAP stay at their values prior to reset. These reset to their start values when the timer is run again

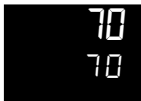







9.4.2 To Run a Soft Start Timer

At start of run controller selects the soft start setpoint and limits the power to the timer soft start power limit.

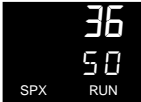
Do This	The Display You Should See	Additional Notes
<p>1. Momentarily press  and  together</p> <p>The timer will not count down if the PV is greater than SP2</p>	  	<p>RUN beacon on</p> <p>Scrolling message 'TIMER RUNNING'</p> <p>SPX beacon on</p> <p>Controller controlling to soft start setpoint</p> <p>Output power limited (40%)</p> <p>Any digital output configured as <i>tRun</i> will operate</p> <p>↓</p> <p>When timed out Scrolling display 'TIMER END' will be indicated</p> <p>Timer end will occur at the end of the Dwell period set even if the soft start temperature has not been reached</p> <p>Controller controlling at the setpoint (70 °C)</p> <p>RUN beacon off</p> <p>Any digital output configured as <i>tEnd</i> will operate</p> <p>Any digital output configured as <i>tRun</i> will cancel</p>
<p>2. Press  and  (Ack) together to reset the timer</p>		<p>Controller continues to control at setpoint (70 °C)</p> <p>TIMER END message cancelled</p> <p>Any digital output configured as <i>tEnd</i> will cancel</p> <p>The timer can be run again from this point</p>



9.4.3 To Hold the Timer

While the timer is running it can be put into Hold (timer stops counting down)

Do This	The Display You Should See	Additional Notes
<p>3. Momentarily press  and  together</p>		<p>RUN beacon flashing</p> <p>Scrolling display 'TIMER HOLD'</p> <p>Controller controlling to soft start setpoint (50 °C)</p> <p>It is possible to reset the timer when in hold by pressing and holding  and  or a digital input etc. It cannot be reset from Ack.</p>
<p>4. Momentarily press  and  together to run the timer from the hold condition</p>		<p>RUN beacon on</p> <p>Scrolling display 'TIMER RUNNING'</p> <p>Controller controlling at soft start setpoint (50 °C)</p>

9.4.4 To Reset the Timer

While the timer is running it can be Reset

Do This	The Display You Should See	Additional Notes
<p>5. Press and hold  and  together</p>		<p>If reset T.REMN and T.ELAP stay at their values prior to reset. These reset to their start values when the timer is run again</p>

9.5 Programmer

Model type CP is a controller which also contains a four segment setpoint programmer where each segment consists of a controlled rate ramp to a target setpoint followed by a dwell at that setpoint. These values can be set by the user. The program profile is shown in the diagram below.

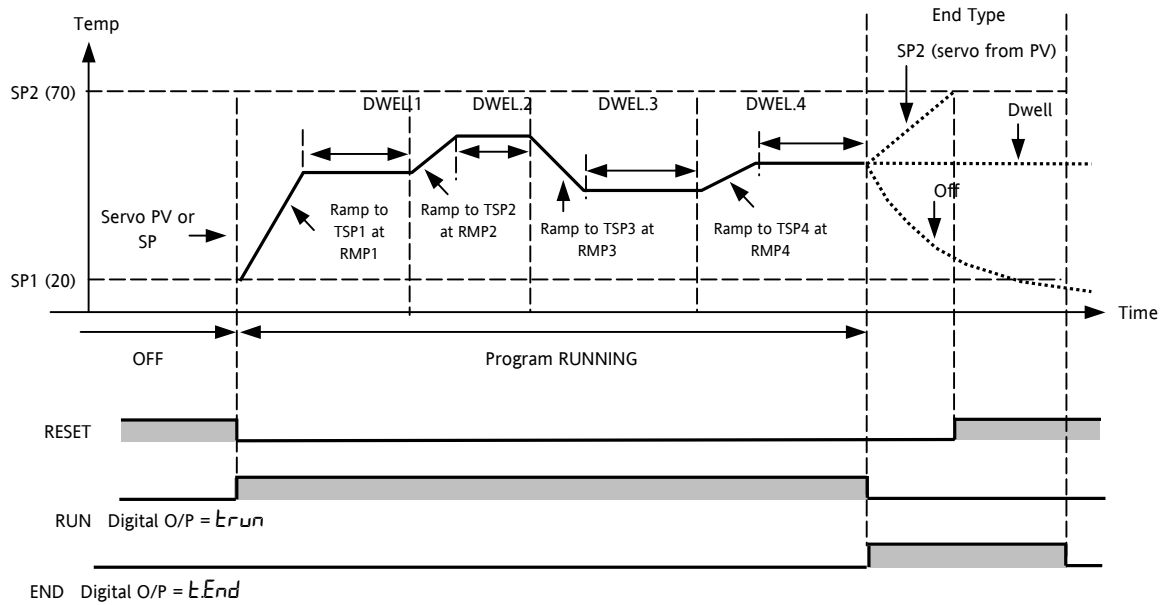

Notes:-

Where steps are required, the ramp rate in the ramp/dwell pair should be set to 'OFF'.

1. Where ramp/dwell pairs are not required, the ramp rate should be set to 'OFF' and the TSP the same as the preceding segment
2. TIMER END – when end type is SP2, Timer END does not occur until the ramp is complete or SP2 is achieved. It is more usual to use a DWELL End Type (the default setting)

9.5.1 Power Cycling (Programmer)

If the power is turned off while the programmer is running the programmer will reset when the power to the programmer is restored.





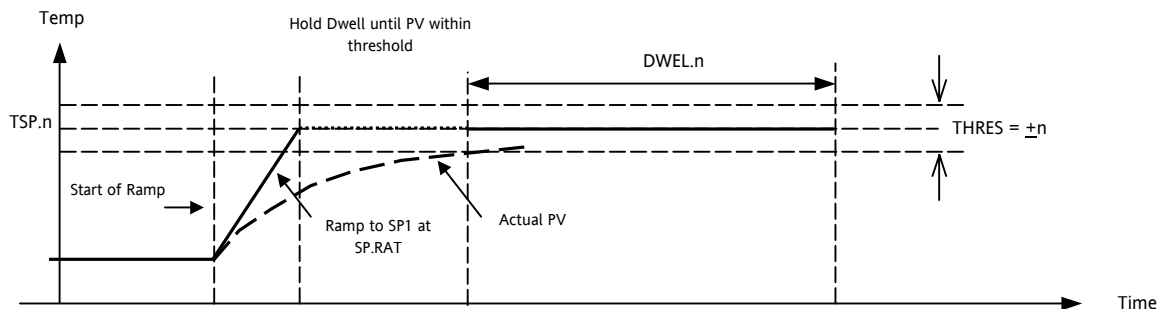





9.5.2 Threshold

A single threshold value is available to provide a holdback on the entry to the dwell part of the ramp/dwell pair. It holds back the dwell until the PV has reached the band defined by +/- threshold around the PV as shown below:-



9.5.3 To Operate the Programmer



































Operation of the programmer is the same as the timer.

Operation	Action	Indication
To Run a program	Press and quickly release  + 	Beacon -- RUN = On Scrolling display - TIMER RUNNING
To Hold a program	Press and quickly release  + 	Beacon -- RUN = Flashing Scrolling display - TIMER HOLD
To Reset a program	Press and hold  +  for more than 1 second	Beacon -- RUN = Off If End Type = Off then OFF will be displayed at the end of the program
	Program ended	Beacon -- RUN = Off SPX = On if End Type = SP2 Scrolling display - TIMER END
To Reset a program after it has timed out	Press and hold  +  for more than 1 second	Beacon -- RUN = Off SPX = On if End Type = SP2 If the programmer is configured to turn power off at the end of the timing period OFF will be displayed.
To Cancel the ' end ' (relay) output (if configured)	Press  + 	If a logic (relay) output is configured to operate when the programmer has timed out, it can be cancelled by pressing these two buttons (Ack)
Repeat the above to Run the programmer again (Note: it is not essential to reset it after the End state is reached)		

Programs can also be operated from the '**T.STAT**' parameter found in the level 2 parameter list.

9.5.4 To Configure the Programmer

Select Access Level 2 – see section 1.11.

Operation	Action	Indication	Notes
Select the TIMER page	1. Press  as many times as necessary to 'TIMER'		
Configure the Timer as a Programmer	2. Press  to select 'TM.CFG' 3. Press  or  to 'Prog'		
Set the Resolution	4. Press  to select 'TM.RES' Press  or  to 'Hour' or 'min'		In this example the ramp rate and dwell period are set in hours
Set the Threshold	5. Press  to select 'THRES' 6. Press  or  to adjust		In this example the dwell periods will not start until the PV is within 5 units of the setpoint
Set the action when the programmer times out	7. Press  to select 'END.T' 8. Press  or  to 'OFF', 'SP2' or 'dwell'		In this example the controller will continue to control indefinitely at the last setpoint. OFF will turn the output power off and SP2 will control at setpoint 2
Set the Servo Mode	9. Press  (twice) to select 'SERVO' 10. Press  or  to 'PU' or 'SP'		In this example the program will start from the current value of the process variable
Set the first Target Setpoint	11. Press  to select 'TSP.1' 12. Press  or  to adjust		In this example the setpoint will ramp from the current value of the PV to the first target - 100
Set the first Ramp Rate	13. Press  to select 'RMP.1' 14. Press  or  to adjust		In this example the setpoint will ramp to 100 at 8.0 units per hour
Set the first Dwell	15. Press  to select 'DWEL.1' 16. Press  or  to adjust		In this example the setpoint will dwell at 100 for 2 hours 11 minutes
Repeat the above three steps for all segments			

9.6 Timer Parameters

The following parameters are available to set up the different timers:-

TIMER LIST 'TIMER'							
Name	Scrolling Display	Parameter Description	Value			Default	Access Level
<i>T M . C F G</i>	TIMER CONFIGURATION	Timer type configuration	<i>nonE</i> <i>dwE11</i> <i>dELY</i> <i>SFSL</i>	Timer disabled Dwell Delayed switch on Soft start		As order code	L3
<i>T M . RES</i>	TIMER RESOLUTION	To set the time units	<i>Hour</i> <i>min</i>	Hours Minutes	HH:MM MM:SS		Conf R/O L3
<i>T H R E S</i>	TIMER START THRESHOLD	To set the maximum deviation between SP and PV before the timer starts. Dwell timer only	<i>OFF</i> or 1 to 3000 Units above and below setpoint			<i>OFF</i>	L3
<i>E N T . T</i>	TIMER END TYPE	To determine the action which takes place when the timer has timed out. Dwell timer only	<i>OFF</i> <i>dwE11</i> <i>SP2</i>	Control outputs go to zero % Control continues at SP1 Go to setpoint 2			Conf
<i>S S . S P</i>	SOFT START SETPOINT	Set the threshold which determines if the power must be limited SFSL timer only	Controller input range			0	Conf
<i>S S . P W R</i>	SOFT START POWER LIMIT	Sets the limit to the power output during start up SFSL timer only	0 to 100%			0	Conf
<i>T . S T A T</i>	TIMER STATUS	Timer status	<i>rES</i> <i>run</i> <i>hold</i> <i>End</i>	Reset Running (counting) Running (hold) Timed out			L3
<i>S E R V O</i>	SERVO MODE	Program starts from current setpoint or current process value	<i>SP</i> <i>PU</i>	Setpoint Process value		<i>SP</i>	
<i>T S P . 1</i>	TARGET SETPOINT 1	To set the target value for the first setpoint	Controller input range			0	L2
<i>R M P . 1</i>	RAMP RATE 1	To set the first ramp rate	<i>OFF</i> , 0:1 to 3000 units per min or hour			<i>OFF</i>	L2
<i>D W E L . 1</i>	DWELL 1		<i>OFF</i> , 0:01 to 99:59 hh:mm or mm:ss				
The above three parameters are repeated for the next 3 program segments, i.e. TSP.2, (3 & 4), RMP.2 (3 & 4), DWEL.2 (3 & 4)							
<i>D W E L L</i>	SET TIMER DURATION	To set the time duration	0:00 to 99:59 hh:mm or mm:ss			0	L3
<i>T . E L A P</i>	ELAPSED TIME	Time elapsed from when the timer starts to run	0:00 to 99.59 hh:mm or mm:ss				L3 read only
<i>T . R E M N</i>	TIME REMAINING	Time remaining to reach the set time.	0:00 to 99.59 hh:mm or mm:ss				L3
The timer can be restarted from the Reset condition by changing the time remaining parameter.							

9.7 Example: To Configure a Timer as a Simple Two Step Programmer

The example shown in 9.2.7 will be used with the controller configuration as follows:-

- Output 2 Heat output relay
- I/O 1 Timer End digital output
- AA Relay Timer running digital output
- Dig Input Run/Reset input



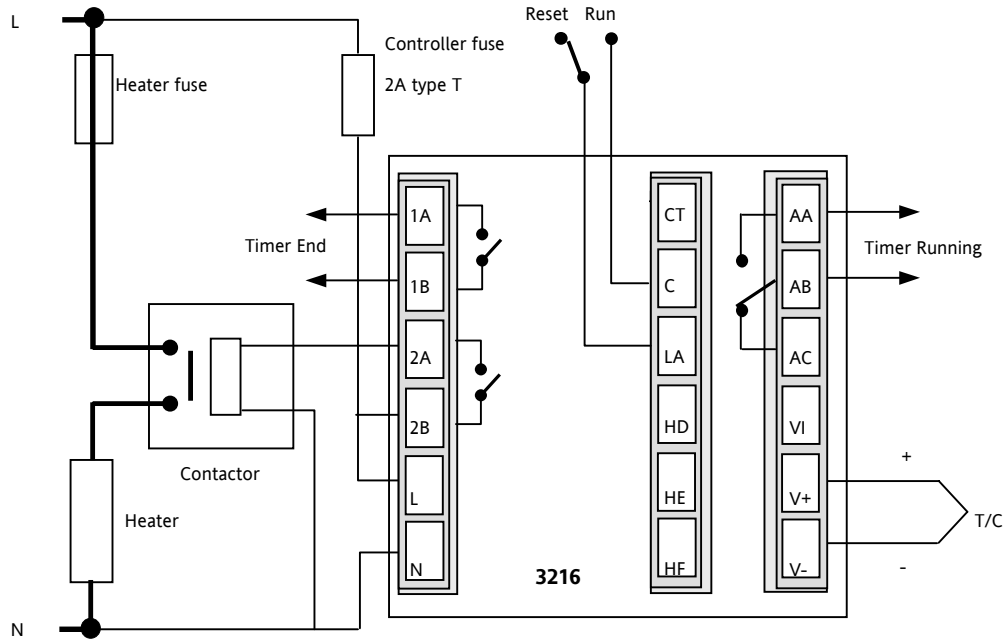



A typical wiring diagram for this example is shown below:-





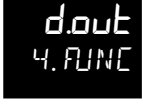

Configure the I/O

Enter configuration level described in section 2.1.3. Then:-

Do This	The Display You Should See	Additional Notes
1. Press as many times as necessary to select 'IO - 1'		To configure the timer end digital output signal Scrolling display 'IO - 1 LIST'
2. Press (twice) to select 'I. FUNC'		Scrolling display 'IO - 1 FUNCTION'
3. Press or to choose d.out		
4. Press to scroll to 'I. SRC. A'		Also I SRC. B I SRC. C I SRC. D =nonE and I SENS =nor to energise the relay when the timer is in the end state
5. Press or to choose t.End		Scrolling display 'IO - 1 SOURCE'
6. Press as many times as necessary to select 'OP - 2'		To configure the control output Scrolling display 'OUTPUT 2 LIST'

<p>7. Press to select '2. FUNC'</p> <p>8. Press or to choose HEAT</p>		<p>Also 2.PLS = 50 and 2.SENS = nor Scrolling display 'OUTPUT 2 FUNCTION'</p>
<p>9. Press as many times as necessary to select 'AA'</p>		<p>To configure the AA relay timer run digital output signal Scrolling display 'AA RELAY'</p>
<p>10. Press to select '4. FUNC'</p> <p>11. Press or to choose dout</p>		<p>Scrolling display 'OUTPUT 4 FUNCTION'</p>
<p>12. Press to select '4. SRC. A'</p> <p>13. Press or to choose trun</p>		<p>Also 4.SRC.D 4.SRC.C 4.SRC.D = nonE and 4.SENS = nor to energise the relay when the timer is in the running state Scrolling display 'OUTPUT 4 SOURCE'</p>
<p>14. Press as many times as necessary to select 'LA'</p>		<p>To configure the LA digital input to Run/Reset the timer from an external contact</p>
<p>15. Press to select 'L.IIN'</p> <p>16. Press or to choose trrs</p>		<p>Make to Run, break to Reset</p>

Configure the Timer

Do This	The Display You Should See	Additional Notes
<p>17. Press as many times as necessary to select 'TIMER'</p>		<p>To configure the timer. This can also be done in Level 3. Scrolling display 'TIMER LIST'</p>
<p>18. Press to select 'TM.CFG'</p> <p>19. Press or to choose dwELL</p>		<p>Also TM.RES = min or Hour as required Scrolling display 'TIMER CONFIGURATION'</p>
<p>20. Press to select 'THRES'</p> <p>21. Press or to choose 2</p>		<p>To ensure the dwell starts when PV reaches 2° of setpoint Scrolling display 'TIMER START THRESHOLD'</p>
<p>22. Press to select 'END.T'</p> <p>23. Press or to choose SP2</p>		<p>Also set DWELL to the time period required Scrolling display 'TIMER END TYPE'</p>

Return to Level 3 and operate the timer as previously described in section 9.2.8







10. Recipe

A recipe can take a snapshot of the current values and store these into a recipe number.

There are five recipes available, which can store a range of parameter values for different processes. The list of parameters is shown in section 10.3.1.





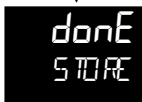



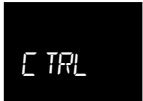

Each recipe can be given a name using iTools configuration software. It is also possible to reconfigure which parameters are included in the recipe list using iTools, see section 13.4.

10.1 To Save Values in a Recipe





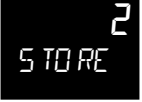

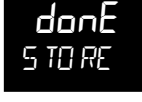
Do This	The Display You Should See	Additional Notes
1. Press  as many times as necessary to select 'RECIPE'		Scrolling display <i>RECIPE LIST</i>
2. Press  to scroll to 'STORE'		Scrolling display <i>RECIPE TO SAVE</i>
3. Press  or  to choose the recipe number to store eg 1		The current parameter values are stored in Recipe 1 If a recipe number is chosen which has not been saved then <i>FAIL</i> will be displayed

10.2 To Save Values in a Second Recipe

In this example the proportional band will be changed and stored in recipe 2. All other values will remain the same as recipe 1:-

Do This	The Display You Should See	Scrolling display Additional Notes
1. Press  to scroll to 'CTRL'		Scrolling display <i>CONTROL LIST</i>
2. Press  to scroll to <i>PB</i>		Scrolling display <i>PROPORTIONAL BAND</i>
3. Press  or  to change the value eg 22		
4. Press  to scroll to 'RECIPE'		Scrolling display <i>RECIPE LIST</i>
5. Press  to 'STORE'		Scrolling display <i>RECIPE TO SAVE</i>
6. Press  or  to 2		

10.3 To Select a Recipe to Run

Do This	The Display You Should See	Additional Notes
1. Press  as many times as necessary to select 'RECIPE'		Scrolling display <i>RECIPE LIST</i>
2. Press  to select 'REC. NO'		Scrolling display <i>CURRENT RECIPE NUMBER</i> The values stored in Recipe 1 will now be used
3. Press  or  to choose recipe number 1		

10.3.1 List of Default Recipe Parameters:

Instrument resolution is always saved and restored, as are instrument units, proportional band units and dwell resolution. The following parameters are the other default recipe parameters.

<i>PB</i>	Proportional Band	<i>R1.XX</i>	Alarm 1 threshold1
<i>TI</i>	Integral time	<i>R2.XX</i>	Alarm 2 threshold2
<i>TD</i>	Derivative time	<i>R3.XX</i>	Alarm 3 threshold3
<i>DBAND</i>	Channel 2 deadband	<i>R4.XX</i>	Alarm 4 hreshold4
<i>CB.LO</i>	Cutback low	<i>LBT</i>	Loop break time
<i>CB.HI</i>	Cutback high	<i>HYST.H</i>	Channel 1 hysteresis
<i>R2G</i>	Relative cool gain	<i>HYST.C</i>	Channel 2 hysteresis
<i>SP1</i>	Setpoint 1	<i>HOME</i>	Home Display
<i>SP2</i>	Setpoint 2	<i>SP.HI</i>	Setpoint High limit
<i>MR</i>	Manual reset On/off only	<i>SP.LO</i>	Setpoint Low limit
<i>OP.HI</i>	Output high limit	<i>TM.CFG</i>	Timer configuration
<i>OP.LO</i>	Output low limit	<i>TM.RES</i>	Timer reset
<i>SAFE</i>	Safe Output	<i>SS.SP</i>	Soft start setpoint
<i>SP.RAT</i>	Setpoint rate limit	<i>SS.PWR</i>	Soft start power limit
<i>R1.HYS</i>	Alarm 1 hysteresis	<i>DWELL</i>	Set time duration
<i>R2.HYS</i>	Alarm 2 hysteresis	<i>THRES</i>	Timer Threshold
<i>R3.HYS</i>	Alarm 3 hysteresis	<i>END.T</i>	Timer End Type
<i>R4.HYS</i>	Alarm 4 hysteresis		Ramp Units

11. Digital Communications

Digital Communications (or 'comms' for short) allows the controller to communicate with a PC or a networked computer system. Digital communications is not available in 3116 controllers.

This product conforms to MODBUS RTU[®] protocol a full description of which can be found on www.modbus.org.

Two ports are available both using MODBUS RTU communication facilities:

1. a configuration port - intended to communicate with a system to download the instrument parameters and to perform manufacturing tests and calibration
2. an optional RS232 or RS485 port on terminals HD, HE and HF - intended for field communications using, for example, a PC running a SCADA package.

The two interfaces cannot operate at the same time.

For a full description of digital communications protocols (ModBus RTU) refer to the 2000 series Communications Handbook, part number HA026230, available on www.eurotherm.co.uk.

Each parameter has its own unique ModBus address. A list of these is given at the end of this section.

11.1 Digital Communications Wiring

11.1.1 RS232

To use RS232 the PC will be equipped with an RS232 port, usually referred to as COM 1.

To construct a cable for RS232 operation use a three core screened cable.

The terminals used for RS232 digital communications are listed in the table below. Some PC's use a 25 way connector although the 9 way is more common.

Standard Cable Colour	PC socket pin no.		PC Function *	Instrument Terminal	Instrument Function
	9 way	25 way			
White	2	3	Receive (RX)	HF	Transmit (TX)
Black	3	2	Transmit (TX)	HE	Receive (RX)
Red	5	7	Common	HD	Common
Link together	1 4 6	6 8 11	Rec'd line sig. detect Data terminal ready Data set ready		
Link together	7 8	4 5	Request to send Clear to send		
Screen		1	Ground		

* These are the functions normally assigned to socket pins. Please check your PC manual to confirm.

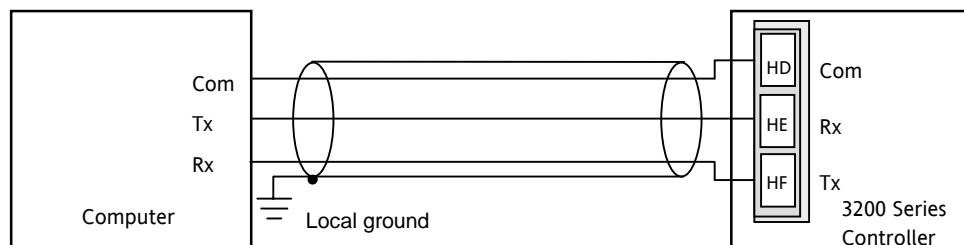

11.1.2 RS485

To use RS485, buffer the RS232 port of the PC with a suitable RS232/RS485 converter. The Eurotherm Controls KD485 Communications Adapter unit is recommended for this purpose. The use of a RS485 board built into the computer is not recommended since this board may not be isolated, which may cause noise problems, and the RX terminals may not be biased correctly for this application.

To construct a cable for RS485 operation use a screened cable with one (RS485) twisted pair plus a separate core for common. Although common or screen connections are not necessary, their use will significantly improve noise immunity.

The terminals used for RS485 digital communications are listed in the table below.

Standard Cable Colour	PC Function *	Instrument Terminal	Instrument Function
White	Receive (RX+)	HF (B) or (B+)	Transmit (TX)
Red	Transmit (TX+)	HE (A) or (A+)	Receive (RX)
Green	Common	HD	Common
Screen	Ground		

- These are the functions normally assigned to socket pins. Please check your PC manual to confirm .

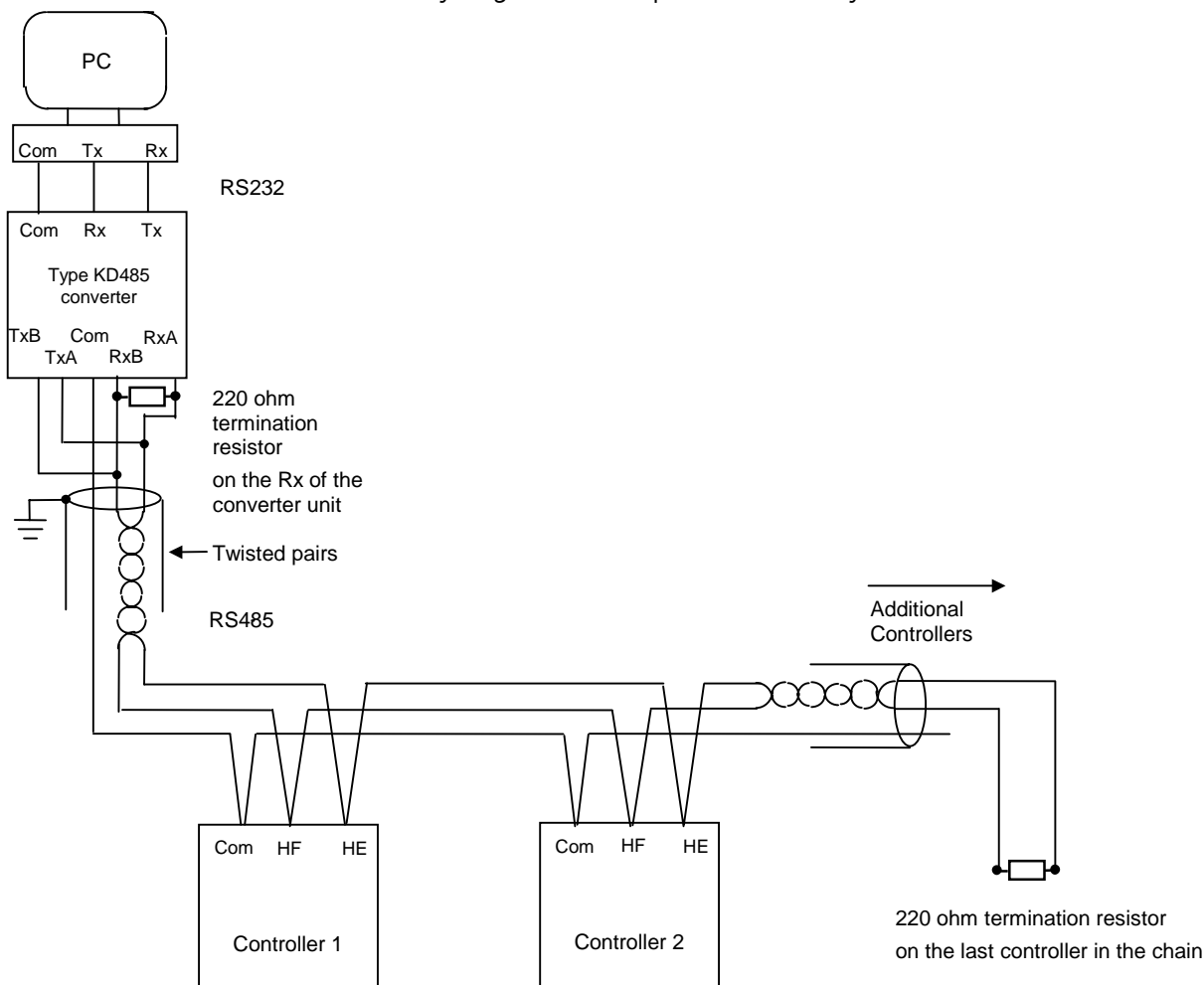

11.2 Digital Communications Parameters

The following table shows the parameters available.

DIGITAL COMMUNICATIONS LIST						
COMMS						
Name	Scrolling Display	Parameter Description	Value		Default	Access Level
<i>I ID</i>	MODULE IDENTITY	Comms identity	<i>nonE</i>	No module fitted	As order code	Conf L3 R/O
			<i>r232</i>	RS 232 Modbus interface		
			<i>r485</i>	RS485 Modbus interface		
<i>R ID R</i>	COMMUNICATIONS ADDRESS	Communications address of the instrument	<i>1</i> to <i>254</i>		<i>1</i>	L3
<i>B A U D</i>	COMMUNICATIONS BAUD RATE	Communications baud rate	<i>1200</i>	1200	<i>9600</i>	Conf L3 R/O
			<i>2400</i>	2400		
			<i>4800</i>	4800		
			<i>9600</i>	9600		
			<i>19.20</i>	19,200		
<i>P R I T Y</i>	COMMUNICATIONS PARITY	Communications parity	<i>nonE</i>	No parity	<i>nonE</i>	Conf L3 R/O
			<i>EvEn</i>	Even parity		
			<i>Odd</i>	Odd parity		
<i>D E L A Y</i>	RX/TX DELAY TIME		<i>OFF</i>	No delay		Conf L3 R/O
			<i>on</i>	Fixed delay. This inserts a delay between Rx and Tx to ensure that drivers have sufficient time to switch over.		
<i>R E T R A N</i>	COMMS RETRANSMISSION	Master comms broadcast parameter. See section 11.2.1.	<i>nonE</i>	None	<i>nonE</i>	
			<i>wSP</i>	Working setpoint		
			<i>PV</i>	Process Variable		
			<i>OP</i>	Output demand		
			<i>Err</i>	Error		
<i>R E G. A D</i>	COMMS RETRANSMISSION ADDRESS	Address of the parameter to be retransmitted See section 11.2.1.	<i>0</i> to <i>9999</i>		<i>0</i>	

11.2.1 Broadcast Communications

Broadcast communications as a simple master or as a slave is available on 3216 controllers from software versions 1.10 or greater. Broadcast master communications will allow the 3216 controller to send a single value to any slave instruments using a Modbus broadcast using function code 6 (Write single value). This allows the 3216 to link through digital communications with other products without the need for a supervisory PC to create a small system solution. Example applications include multi-zone profiling applications or cascade control using a second controller. The facility provides a simple and precise alternative to analogue retransmission.

The retransmitted parameter can be selected from Setpoint, Process Variable, Output Demand or Error. The controller will cease broadcast when it receives a valid request from a Modbus master - this allows iTools to be connected for commissioning purposes.



Warning

When using broadcast master communications, bear in mind that updated values are sent many times a second. Before using this facility, check that the instrument to which you wish to send values can accept continuous writes. **Note that in common with many third party lower cost units, the Eurotherm 2200 series and the 3200 series prior to version V1.10 do not accept continuous writes to the temperature setpoint. Damage to the internal non-volatile memory could result from the use of this function. If in any doubt, contact the manufacturer of the device in question for advice.**

When using the 3200 series fitted with software version 1.10 and greater, use the Remote Setpoint variable at Modbus address 26 if you need to write to a temperature setpoint. This has no write restrictions and may also have a local trim value applied. There is no restriction on writing to the 2400 or 3500 series.

11.2.2 Broadcast Master Communications

The 3216 broadcast master can be connected to up to 31 slaves if no segment repeaters are used. If repeaters are used to provide additional segments, 32 slaves are permitted in each new segment. The master is configured by setting the 'RETRAN' parameter to *wSP*, *PU*, *OP* or *Err*.

Once the function has been enabled, the instrument will send this value out over the communications link every control cycle (110ms).

Notes:-

1. The parameter being broadcast must be set to the same decimal point resolution in both master and slave instruments.
2. If iTools, or any other Modbus master, is connected to the port on which the broadcast master is enabled, then the broadcast is temporarily inhibited. It will restart approximately 30 seconds after iTools is removed. This is to allow reconfiguration of the instrument using iTools even when broadcast master communications is operating.

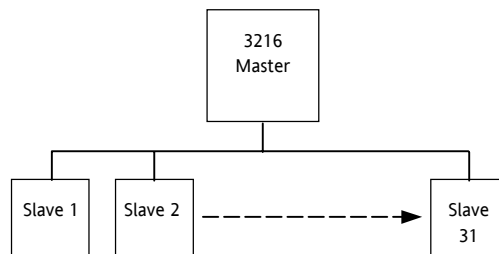

11.2.3 Wiring Connections

The Digital Communications module for use as a master or slave is fitted in Comms Module slot H and uses terminals HA to HF.



RS422, RS485 4-wire or RS232

Rx connections in the master are wired to Tx connections of the slave

Tx connections in the master are wired to Rx connections of the slave

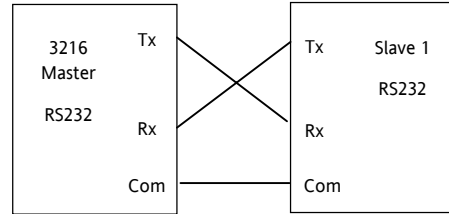
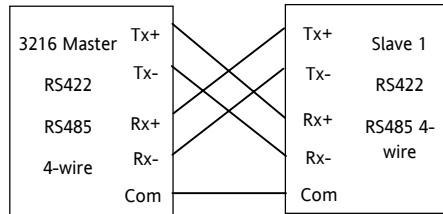

RS485 2-wire



Connect A (+) in the master to A (+) of the slave





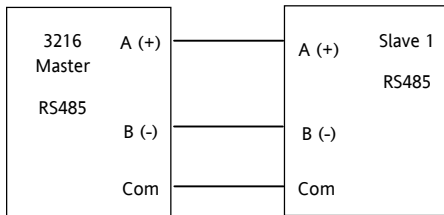





Connect B (-) in the master to B (-) of the slave

This is shown diagrammatically below



11.3 Example To Set Up Instrument Address

This can be done in operator level 3:-

Do This	The Display You Should See	Additional Notes
1. Press  as many times as necessary to select 'COMMS LIST'		Scrolling display 'COMMS LIST'
2. Press  to scroll to 'ID' 3. Press  or  to select RS232 or RS485 comms		Scrolling display 'ID'
4. Press  to scroll to 'ADDRESS' 5. Press  or  to select the address for the particular controller		Up to 254 can be chosen but note that no more than 33 instruments should be connected to a single RS485 link. Scrolling display 'ADDRESS' For further information see 2000 Series Communications Handbook Part No. HA026230 available on www.eurotherm.co.uk

11.4 Data Encoding



Note that the Eurotherm Itools OPC server provides a straightforward means of accessing any variable in the 3200 controller in the correct data format without the need to consider data representation. However if you wish to write your own communications interface software, you will need to take the format used by the 3200 comms software into account.

Modbus data is normally encoded into a 16 bit signed integer representation.

Integer format data, including any value without a decimal point or represented by a textual value (for example 'off', or 'on', is sent as a simple integer value.

For **floating point** data, the value is represented as a 'scaled integer', in which the value is sent as an integer which gives the result of the value multiplied by 10 to the power of the decimal resolution for that value. This is easiest to understand by reference to examples:

FP Value	Integer Representation
9.	9
-1.0	10
123.5	1235
9.99	999

It may be necessary for the Modbus master to insert or remove a decimal point when using these values.

It is possible to read floating point data in a native 32 bit IEEE format. This is described in the Eurotherm Series 2000 Communications Handbook (HA026230), Chapter 7.

For **time** data, for example the length of a dwell, the integer representation depends on the resolution. For 'hours' resolution, the value returned is the number of minutes the value represents, so for example a value of 2:03 (2 hours and three minutes) would be returned as an integer value of 123. For 'minutes' resolution, the value used is the number of seconds the value represents, so that 12:09 (12 minutes and 9 seconds) would be returned as 729.

It is possible to read time data in a native 32 bit integer format, in which case it returns the number of milliseconds the variable represents regardless of the resolution. This is described in the Eurotherm Series 2000 Communications Handbook (HA026230), Chapter 7.

11.5 Parameter Modbus Addresses

Parameter Mnemonic	Parameter Name	Modbus Address
PV.IN	PV (Temperature) Input Value (see also Modbus address 203 which allows writes over Modbus to this variable).	1
TG.SP	Target Setpoint. <i>NB – do not write continuously changing values to this variable. The memory technology used in this product has a limited (100,000) number of write cycles. If ramped setpoints are required, consider using the internal ramp rate function or the remote comms setpoint (Modbus address 26)in preference.</i>	2
MAN.OP	Manual Output Value	3
WRK.OP	Working Output	4
WKG.SP	Working Setpoint (Read Only)	5
PB	Proportional Band	6
CTRL.A	Control Action 0 = Reverse Acting 1 = Direct Acting	7

Parameter Mnemonic	Parameter Name	Modbus Address
Ti	Integral Time (0 = No Integral Action)	8
Td	Derivative Time (0 = No Derivative Action)	9
RNG.LO	Input Range Low Limit	11
RNG.HI	Input Range High Limit	12
A1.---	Alarm 1 Threshold	13
A2.---	Alarm 2 Threshold	14
SP.SEL	Active Setpoint Select 0 = Setpoint 1 1 = Setpoint 2	15
D.BAND	Channel 2 Deadband	16
cB.Lo	Cutback Low	17
cB.HI	Cutback High	18
R2G	Relative Cool/Ch2 Gain	19
T.STAT	Timer Status 0 = Reset 1 = Run 2 = Hold 3 = End	23
SP1	Setpoint 1 <i>NB – do not write continuously changing values to this variable. The memory technology used in this product has a limited (100,000) number of write cycles. If ramped setpoints are required, consider using the internal ramp rate function or the remote comms setpoint (Modbus address 26)in preference.</i>	24
SP2	Setpoint 2 <i>NB – do not write continuously changing values to this variable. The memory technology used in this product has a limited (100,000) number of write cycles. If ramped setpoints are required, consider using the internal ramp rate function or the remote comms setpoint (Modbus address 26)in preference.</i>	25
Rm.SP	Remote (comms) setpoint. If selected using the remote setpoint selection (address 276 below, may also be controlled using the instrument HMI or a digital input) then this is used as a setpoint providing a value has been received within a window of about 5 seconds. If no value is received then the controller falls back to the currently selected setpoint (SP 1 or SP 2) with an error indication. The Remote Setpoint may have a local trim (SP Trim, address 27) added to it to compensate for variations in temperature in a particular zone. This parameter is not saved when the instrument is switched off. It may be written to continuously over communications without risk of damage to the instrument non-volatile memory.	26
LOC.t	Local Trim – added to the remote setpoint to compensate for local temperature variations in a control zone.	27
MR	Manual Reset	28
OP.HI	Output High Limit	30
OP.LO	Output Low Limit	31

Parameter Mnemonic	Parameter Name	Modbus Address
SAFE	Safe Output Value for Sensor Break or other fault conditions.	34
SP.RAT	Setpoint Rate Limit Value (0 = no rate limit)	35
P.Err	Calculated Error (PV-SP)	39
A1.HYS	Alarm 1 Hysteresis	47
A2.HYS	Alarm 2 Hysteresis	68
A3.HYS	Alarm 3 Hysteresis	69
A4.HYS	Alarm 4 Hysteresis	71
StAt	Instrument Status. This is a bitmap: B0 – Alarm 1 Status B1 – Alarm 2 Status B2 – Alarm 3 Status B3 – Alarm 4 Status B4 – Auto/Manual Status B5 – Sensor Break Status B6 – Loop Break Status B7 – CT Low load current alarm status B8 – CT High leakage current alarm status B9 – Program End B10 – PV Overrange (by > 5% of span) B11 – CT Overcurrent alarm status B12 – New Alarm Status B13 – Timer/Ramp Running B14 – Remote (comms) SP Fail B15 – Autotune Status In each case, a setting of 1 signifies 'Active', 0 signifies 'Inactive'.	75
LL.AMP	Load Leakage Current	79
LD.AMP	Load ON Current	80
A3.---	Alarm 3 Threshold	81
A4.---	Alarm 4 Threshold	82
LBT	Loop Break Time	83
HYST.H	Ch1 On/Off Hysteresis in Eng Units	86
Di.IP	Digital Inputs Status. This is a bitmap: B0 – Logic input 1A B1 – Logic input LA B7 – Power has failed since last alarm acknowledge A value of 1 signifies the input is closed, otherwise it is zero. Values are undefined if options are not fitted or not configured as inputs.	87
HYST.C	Ch2 On/Off Hysteresis in Eng Units	88
FILT.T	Input Filter Time	101
Home	Home Display. 0 – Standard PV and SP display 1 – PV and Output Power display 2 – PV and Time remaining display	106

Parameter Mnemonic	Parameter Name	Modbus Address
	3 – PV and Timer elapsed time display 4 – PV and Alarm 1 setpoint 5 – PV and Load Current 6 – PV only 7 – PV and Composite SP/Time remaining	
-	Instrument version number. Should be read as a hexadecimal number, for example a value of 0111 hex is instrument V1.11	107
SP.HI	Setpoint High Limit	111
SP.LO	Setpoint Low Limit	112
-	Instrument type code.	122
ADDR	Instrument Comms Address	131
PV.OFS	PV Offset	141
C.Adj	Calibration Adjust	146
IM	Instrument Mode 0 – Auto Mode (normal control) 1 – Manual Mode 2 – Standby Mode	199
MV.IN	Input value in millivolts	202
PV.CM	Comms PV Value. This may be used to write to the Process Variable (temperature) parameter over Modbus when a linearisation type of 'Comms' is selected, allowing the instrument to control to externally derived values. If sensor break is turned on, it is necessary to write to this variable once every 5 seconds. Otherwise a sensor break alarm will be triggered as a failsafe. If this is not required, turn sensor break off.	203
CJC.IN	CJC Temperature	215
SBR	Sensor Break Status (0 = Off, 1 = Active)	258
NEW.AL	New Alarm Status (0 = Off, 1 = Active)	260
LBR	Loop Break (0 = Off, 1 = Active)	263
A.TUNE	Autotune Enable (0 = Off, 1 = Enabled)	270
A-M	Mode of the Loop (0 = Auto, 1 = Manual)	273
Ac.All	Acknowledge all alarms (1 = Acknowledge)	274
L-R	Local Remote (Comms) Setpoint Select	276
A1.STS	Alarm 1 Status (0 = Off, 1 = Active)	294
A2.STS	Alarm 2 Status (0 = Off, 1 = Active)	295
A3.STS	Alarm 3 Status (0 = Off, 1 = Active)	296
A4.STS	Alarm 4 Status (0 = Off, 1 = Active)	297
LD.ALM	Low Load Current Threshold	304
LK.ALM	High Leakage Current Alarm (0 = Off, 1 = Active)	305
HC.ALM	Over Current Alarm Threshold	306
LOAD.A	Load Alarm Status (0 = Off, 1 = Active)	307
LEAK.A	Leak alarm Status.	308
HILC.A	Over Current alarm Status (0 = Off, 1 = Active)	309
REC.NO	Recipe to Recall	313
StOrE	Recipe to Save	314
TM.CFG	Timer type configuration	320

Parameter Mnemonic	Parameter Name	Modbus Address
	0 – No Timer 1 – Dwell Timer 2 – Delay Timer 3 – Soft Start Timer 10 – Programmer (Programmer Option only)	
TM.RES	Timer Resolution 0 – Hours:Mins 1 – Mins:Secs	321
SS.SP	Soft Start Setpoint	322
SS.PWR	Soft Start Power Limit	323
DWELL	Requested Timer Duration	324
T.ELAP	Elapsed Time	325
T.REMN	Time Remaining	326
THRES	Timer Start threshold	327
End.T	Timer End Type 0 – Off 1 – Dwell at current setpoint 2- Transfer to Setpoint 2 and dwell	328
SERVO	'Servo' Mode (programmer option only) 0 – Start first ramp from current Working Setpoint 1 - Start first ramp from current PV (temperature)	329
CTRL.H	Heat/Ch1 Control Type 0 – Off 1 – On/Off Control 2 – PID Control	512
CTRL.C	Cool/Ch2 Control Type 0 – Off 1 – On/Off Control 2 – PID Control	513
PB.UNT	Proportional Band Units 0 – Engineering Units 1 – Percent of Span	514
Lev2.P	Level 2 Code	515
UNITS	Display Units 0 – Degrees C 1 – Degrees F 2 – Kelvin 3 – None 4 – Percent	516
Lev3.P	Level 3 Code	517
Conf.P	Config Code	518
Cold	If set to 1 instrument will reset to factory defaults on next reset or power cycle.	519
COOL.t	Cooling Algorithm Type:	524

Parameter Mnemonic	Parameter Name	Modbus Address
	0 – Linear 1 – Oil 2 – Water 3 – Fan	
DEC.P	Decimal Point Position 0 – XXXX. 1 – XXX.X 2 – XX.XX	525
STBY.T	Standby Type 0 – Absolute Alarm Outputs Active – others off 1 – All outputs inactive	530
RAMP UNITS	0 – Ramp per Minute 1 – Ramp per Hour 2 – Ramp per Second	531
Meter	(3208/3204 Only). Ammeter configuration 0 – No ammeter 1 – Heat Output (0-100%) 2 – Cool Output (0-100% cooling) 3 – Working Setpoint (scaled within SP limits) 4 – PV (scaled within range) 5 – Output Power (scaled within Op Low and OP High limits) 6 – Output centered between –100% and 100% 7 – Error (PV-SP) (scaled between +/- 10 degrees) 8 – Instantaneous Amps (scaled 0 to CT Span) 9 – Load Current (scaled 0 to CT Span)	532
uCAL	User Calibration Enable	533
A1.TYP	Alarm 1 Type 0 – Off 1 – Absolute High 2 – Absolute Low 3 – Deviation High 4 – Deviation Low 5 – Deviation Band	536
A2.TYP	Alarm 2 Type (as Alarm 1 Type)	537
A3.TYP	Alarm 3 Type (as Alarm 1 Type)	538
A4.TYP	Alarm 4 Type (as Alarm 1 Type)	539
A1.LAT	Alarm 1 Latching Mode 0 – No latching 1 – Latch - Automatic Reset 2 – Latch – Manual Reset	540
A2.LAT	Alarm 2 Latching Mode	541

Parameter Mnemonic	Parameter Name	Modbus Address
	(as Alarm 1 Latching Mode)	
A3.LAT	Alarm 3 Latching Mode (as Alarm 1 Latching Mode)	542
A4.LAT	Alarm 4 Latching Mode (as Alarm 1 Latching Mode)	543
A1.BLK	Alarm Blocking Mode Enable (0 = OFF, 1 = BLOCK)	544
A2.BLK	Alarm Blocking Mode Enable (0 = OFF, 1 = BLOCK)	545
A3.BLK	Alarm Blocking Mode Enable (0 = OFF, 1 = BLOCK)	546
A4.BLK	Alarm Blocking Mode Enable (0 = OFF, 1 = BLOCK)	547
Di.OP	Digital Outputs Status. This is a bitmap: B0 – Output 1A B1 – Output 2A B2 – (not used) B3 – Output 4/AA It is possible to write to this status word to use the digital outputs in a telemetry output mode. Only outputs whose function is set to 'none' are affected, and the setting of any bits in the Digital Output Status word will not affect outputs used for heat (for example) or other functions. Thus it is not necessary to mask in the settings of these bits when writing to this variable.	551
OFS.HI	Adjust High Offset	560
OFS.LO	Adjust Low Offset	561
PNT.HI	Adjust High Point	562
PNT.LO	Adjust Low Point	563
CT.RNG	CT Range	572
Sb.tyP	Sensor Break Type 0 – No Sensor Break 1 – Non-Latching Sensor Break 2 – Latching Sensor Break	578
Id	Customer ID – May be set to any value between 0-9999 for identification of instruments in applications. Not used by the instrument itself.	629
PHASE	Calibration Phase 0 – None 1 – 0 mv 2 – 50 mv 3 – 150 Ohm 4 – 400 Ohm 5 – CJC 6 – CT 0 mA 7 – CT 70 mA 8 – Factory Defaults 9 – Output 1 mA low cal 10 – Output 1 mA high cal 11 – Output 2 mA low cal 12 – Output 2 mA high cal	768

Parameter Mnemonic	Parameter Name	Modbus Address
	13 – Output 3 ma low cal (3208/3204 only) 14 – Output 3 ma high cal (3208/3204 only)	
GO	Calibration Start 0 – No 1 – Yes (start cal) 2 – Cal Busy 3 – Cal Pass 4 – Cal Fail Note values 2-4 cannot be written but are status returns only	769
-	Analogue Output Calibration Value	775
K.LOC	Allows instrument to be locked via a key/digital input 0 - unlocked, 1 – all keys locked 2 – Edit keys (raise and lower) disabled 3 – Mode key disabled 4 – Manual mode disabled 5 – Enter standby mode when Mode combination pressed 6 – Timer keys disabled	1104
Dwel.1	Programmer Dwell 1 Duration (3208 only)	1280
TSP.1	Programmer Target Setpoint 1 (3208 only)	1281
RMP.1	Programmer Ramp Rate 1 (3208 only)	1282
Dwel.2	Programmer Dwell 2 Duration (3208 only)	1283
TSP.2	Programmer Target Setpoint 2 (3208 only)	1284
RMP.2	Programmer Ramp Rate 2 (3208 only)	1285
Dwel.3	Programmer Dwell 3 Duration (3208 only)	1286
TSP.3	Programmer Target Setpoint 3 (3208 only)	1287
RMP.3	Programmer Ramp Rate 3 (3208 only)	1288
Dwel.4	Programmer Dwell 4 Duration (3208 only)	1289
TSP.4	Programmer Target Setpoint 4 (3208 only)	1290
RMP.4	Programmer Ramp Rate 4 (3208 only)	1291
IN.TYP	Input Sensor Type 0 – J Type Thermocouple 1 – K Type Thermocouple 2 – L Type Thermocouple 3 – R Type Thermocouple 4 – B Type Thermocouple 5 – N Type Thermocouple 6 – T Type Thermocouple 7 – S Type Thermocouple 8 – RTD 9 – millivolt 10 – Comms Input (see Modbus address 203) 11 – Custom Input (Downloadable)	12290
CJ.tyP	CJC Type	12291

Parameter Mnemonic	Parameter Name	Modbus Address
	0 – Auto 1 – 0 Degrees C 2– 50 Degrees C	
mV.HI	Linear Input High	12306
mV.LO	Linear Input Low	12307
L.TYPE	Logic Input A channel hardware type 0 – None 1 – Logic Inputs	12352
L.D.IN	Logic input A function 40 – None 41 – Acknowledge all alarms 42 – Select SP1/2 43 – Lock All Keys 44 – Timer Reset 45 – Timer Run 46 – Timer Run/Reset 47 – Timer Hold 48 – Auto/Manual Select 49 – Standby Select	12353
L.SENS	Configures the polarity of the logic input channel A (0 = Normal, 1 = Inverted)	12361
L.TYPE (LB)	Logic Input B channel hardware type (3208/3204 only) 0 – None 1 – Logic Inputs	12368
L.D.IN (LB)	Logic input B function (3208/3204 only) 40 – None 41 – Acknowledge all alarms 42 – Select SP1/2 43 – Lock All Keys 44 – Timer Reset 45 – Timer Run 46 – Timer Run/Reset 47 – Timer Hold 48 – Auto/Manual Select 49 – Standby Select	12369
L.SENS (LB)	Configures the polarity of the logic input channel B (0 = Normal, 1 = Inverted) (3208/4 only)	12377
ID	Comms Module Type 0 – None 1 – RS485 2 – RS232	12544
BAUD	Baud Rate 0 – 9600 1 – 19200	12548

Parameter Mnemonic	Parameter Name	Modbus Address
	2 – 4800 3 – 2400 4 – 1200	
PRTY	Parity setting 0 – None 1 – Even 2 – Odd	12549
DELAY	RX/TX Delay – (0 = no delay, 1 = delay) Select if a delay is required between received and transmitted comms messages. Sometimes required when intelligent RS485 adaptors are used.	12550
RETRN	Comms Retransmission Variable selection: 0 – Off 1 – Working Setpoint 2 – PV 3 – Output Power 4 – Error	12551
REG.AD	Modbus register address to broadcast retransmission to. For example if you wish to retransmit the working setpoint from one 3200 to a group of slaves, and receive the master working setpoint into the slaves' remote setpoint, set this variable to 26 (the address of the remote setpoint in the slave units).	12552
Ct.Id	Current Transformer	12608
CT.SRC	CT Source 0 – None 1 – IO1 2 – OP2 8 – AA (OP4)	12609
CT.LAT	CT Alarm Latch Type 0 – No latching 1 – Latch – Automatic Reset 2 – Latch – Manual Reset	12610
1.ID	IO channel 1 hardware type 0 – None 1 – Relay 2 – Logic I/O	12672
1.D.IN	IO1 Digital input function Logic input function 40 – None 41 – Acknowledge all alarms 42 – Select SP1/2 43 – Lock All Keys 44 – Timer Reset 45 – Timer Run 46 – Timer Run/Reset 47 – Timer Hold 48 – Auto/Manual Select	12673

Parameter Mnemonic	Parameter Name	Modbus Address
	49 – Standby Select	
1.Func	I/O Channel Function 0 – None (or Telemetry Output) 1 – Digital Output 2 – Heat 3 – Cool 4 – Digital Input 10 – DC Output no function 11 – DC Output Heat 12 – DC Output Cool 13 – DC Output WSP retransmission 14 – DC Output PV retransmission 15 – DC Output OP retransmission	12675
1.RNG	IO Channel 1 DC Output Range 0 – 0-20mA 1 – 4-20mA	12676
1.SRC.A	IO Channel 1 Source A 0 – None 1 – Alarm 1 2 – Alarm 2 3 – Alarm 3 4 – Alarm 4 5 – All Alarms (1-4) 6 – New Alarm 7 – CT Alarm (Load, Leak or Overcurrent) 8 – Loop Break Alarm 9 – Sensor Break Alarm 10 – Timer End (or Not Ramping) 11 – Timer Run (or Ramping) 12 – Auto/Manual 13 – Remote Fail – see section 5.1.2 14 – Power fail – see section 5.1.5	12678
1.SRC.B	IO Channel 1 Source B As IO Channel 1 Source A (Modbus address 12678)	12679
1.SRC.C	IO Channel 1 Source C As IO Channel 1 Source A (Modbus address 12678)	12680
1.SRC.D	IO Channel 1 Source D As IO Channel 1 Source A (Modbus address 12678)	12681
1.SENS	Configures the polarity of the input or output channel (0 = Normal, 1 = Inverted)	12682
1.PLS	IO1 Time proportioning Output minimum pulse time	12706
2.ID	Output 2 Type 0 – None 1 – Relay 2 – Logic Output	12736

Parameter Mnemonic	Parameter Name	Modbus Address
2.FUNC	Output 2 Channel function 0 – None (or Telemetry Output) 1 – Digital Output 2 – Heat 3 – Cool 10 – DC Output no function 11 – DC Output Heat 12 – DC Output Cool 13 – DC Output WSP retransmission 14 – DC Output PV retransmission 15 – DC Output OP retransmission	12739
2.RNG	IO Channel 2 DC Output Range 0 – 0-20mA 1 – 4-20mA	12740
2.SRC.A	Output 2 source A As IO Channel 1 Source A (Modbus address 12678)	12742
2.SRC.B	Output 2 source B As IO Channel 1 Source A (Modbus address 12678)	12743
2.SRC.C	Output 2 source C As IO Channel 1 Source A (Modbus address 12678)	12744
2.SRC.D	Output 2 source D As IO Channel 1 Source A (Modbus address 12678)	12745
2.SENS	Output 2 Polarity (0 = Normal, 1 = Inverted)	12746
2.PLS	Output 2 Time proportioning Output minimum pulse time	12770
3.ID	Output 3 Type 0 – None 1 – Relay	12800
3.FUNC	Output 3 Channel function 0 – None (or Telemetry Output) 1 – Digital Output 2 – Heat 3 – Cool 10 – DC Output no function 11 – DC Output Heat 12 – DC Output Cool 13 – DC Output WSP retransmission 14 – DC Output PV retransmission 15 – DC Output OP retransmission	12803
3.RNG	IO Channel 3 DC Output Range 0 – 0-20mA 1 – 4-20mA	12804
3.SRC.A	Output 3 source A As IO Channel 1 Source A (Modbus address 12678)	12806
3.SRC.B	Output 3 source B	12807

Parameter Mnemonic	Parameter Name	Modbus Address
	As IO Channel 1 Source A (Modbus address 12678)	
3.SRC.C	Output 3 source C As IO Channel 1 Source A (Modbus address 12678)	12808
3.SRC.D	Output 3 source D As IO Channel 1 Source A (Modbus address 12678)	12809
3.SENS	Output 3 Polarity (0 = Normal, 1 = Inverted)	12810
3.PLS	Output 3 Time proportioning Output minimum pulse time	12834
4.TYPE	Output AA Type 0 – None 1 – Relay	13056
4.FUNC	Output 4 Channel function 0 – None (or Telemetry Output) 1 – Digital Output 2 – Heat 3 – Cool	13059
4.SRC.A	Output AA source A As IO Channel 1 Source A (Modbus address 12678)	13062
4.SRC.B	Output AA source B As IO Channel 1 Source A (Modbus address 12678)	13063
4.SRC.C	Output AA source C As IO Channel 1 Source A (Modbus address 12678)	13064
4.SRC.D	Output AA source D As IO Channel 1 Source A (Modbus address 12678)	13065
4.SENS	Output Polarity (0 = Normal, 1 = Inverted)	13066
4.PLS	Output AA Time proportioning Output minimum pulse time	13090

12. Calibration

The process value can be offset to take into account known errors within the process. The procedure is carried out in the *INPUT* list as described in sections 4.2 and 4.3.

It is also possible to adjust the low and high points as a two point offset. This is done in Level 3 in the *CAL* list and is described in this section.

All ranges are calibrated during manufacture to traceable standards for every input type. When changing ranges, therefore, it is not necessary to calibrate the controller.

The controller can, however, be field calibrated. This is done in Configuration level in the *CAL* list, and the procedures are described in this section. It is always possible to revert to the factory calibration if necessary.

12.1 Two Point Offset

A two point offset adjusts both a low point and a high point and applies a straight line between them. Any readings above and below the calibration points will be an extension of this straight line. For this reason it is best to calibrate with the two points as far apart as possible as shown in the example below:-

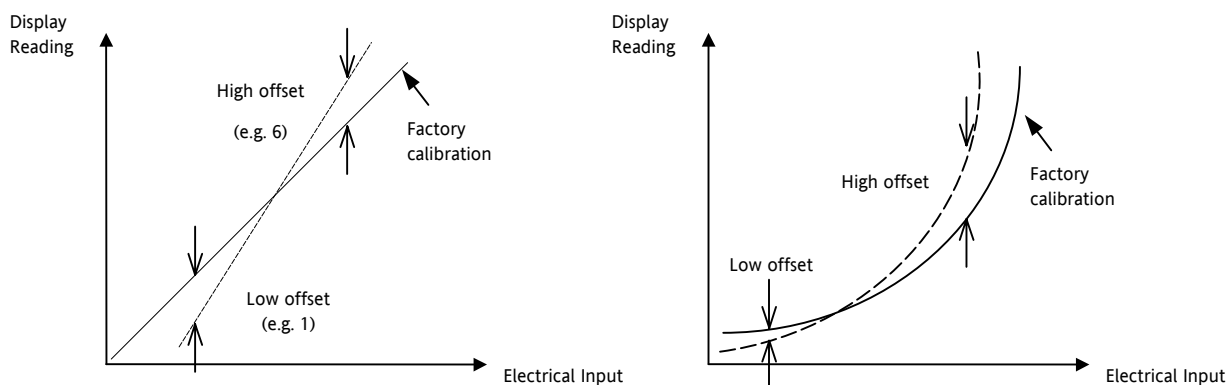

Decide on the high and low points at which you wish to apply the offsets, then:-

Do This	The Display You Should See	Additional Notes
1. Select Level 3 as described in Chapter 2. Then press to select 'CAL'		
2. Press to scroll to 'U.CAL'		Scrolling message <i>USER CALIBRATION</i>
3. Press or to 'Lo'		To revert to the original values, select <i>rSET</i>
4. Press to scroll to 'CALD'		
5. Press or to set the low offset value		
6. Repeat the above for the high offset		

12.2 Input Calibration

Inputs which can be calibrated:-

- **mV Input.** This is a linear 80mV range calibrated at two fixed points. This should always be done before calibrating either thermocouple or resistance thermometer inputs. mA ranges are included in the mV range.
- **Thermocouple** calibration involves calibrating the temperature offset of the CJC sensor only. Other aspects of thermocouple calibration are also included in mV calibration.
- **Resistance Thermometer.** This is also carried out at two fixed points - 150 Ω and 400 Ω .
- **Current Transformer.** This calibrates against the CT in use

12.3 Precautions

Before starting any calibration procedure the following precautions should be taken:-

1. RTD and CJC calibration must not be carried out without prior mV calibration.
2. A pre-wired jig built using a spare instrument sleeve may help to speed up the calibration procedure especially if a number of instruments are to be calibrated.
3. Power should be turned on only after the controller has been inserted in the sleeve of the pre-wired circuit. Power should also be turned off before removing the controller from its sleeve.
4. Allow at least 10 minutes for the controller to warm up after switch on.

12.3.1 To Calibrate mV Range

Calibration of the mV range is carried out using a 50 milli-volt source, connected as shown in the diagram below. mA calibration is included in this procedure.

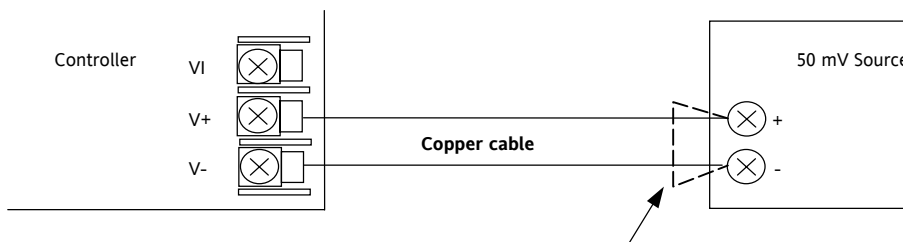

For best results 0mV should be calibrated by disconnecting the copper wires from the mV source and short circuiting the input to the controller

Set the controller input to mV range, then:-

Do This	The Display You Should See	Additional Notes
1. From any display press as many times as necessary until the 'CAL' page header is displayed.		Scrolling display 'CALIBRATION LIST'
2. Press to select 'PHASE'		Scrolling display 'CALIBRATION PHASE'
3. Set mV source for 0mV		
4. Press or to choose '0'		
5. Press to select 'GO'		Scrolling display 'CALIBRATION START'
6. Press or to choose 'YES'	 	The controller automatically calibrates to the injected input mV. As it does this the display will show <i>bUSY</i> then <i>PASS</i> , assuming a successful calibration. If it is not successful then 'FAIL' will be displayed. This may be due to an incorrect input mV
7. Set mV source for 50mV		
8. Press to select 'PHASE'		The controller will again automatically calibrate to the injected input mV.
9. Press or to choose '50'		
10. Repeat 5 and 6 above to calibrate the high point		If it is not successful then 'FAIL' will be displayed

12.3.2 Thermocouple Calibration

Thermocouples are calibrated, firstly, by following the previous procedure for the mV ranges, then calibrating the CJC.

This can be carried out using an external CJC reference source such as an ice bath or using a thermocouple mV source. Replace the copper cable shown in the diagram below with the appropriate compensating cable for the thermocouple in use.

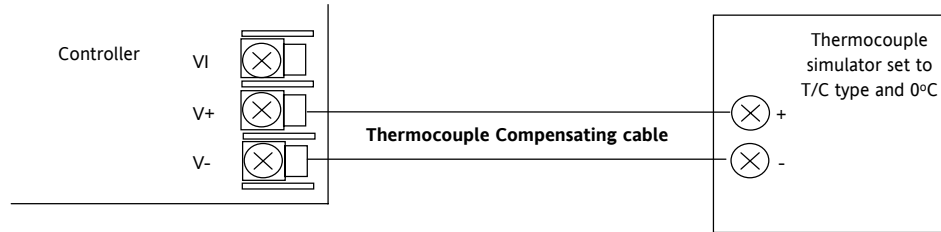

Set the mV source to **internal compensation** for the thermocouple in use and set the output for **0mV**. Then:-

Do This	The Display You Should See	Additional Notes
1. From the mV calibration, press or to select 'CJC'		
2. Press to select 'GO' 3. Press or to choose 'YES'	 	The controller automatically calibrates to the CJC input at 0mV. As it does this the display will show <i>busy</i> then <i>PASS</i> , assuming a successful calibration. If it is not successful then 'FAIL' will be displayed. This may be due to an incorrect input mV

12.3.3 RTD Calibration

The two points at which the RTD range is calibrated are 150.00Ω and 400.00Ω.

Before starting RTD calibration:

- A decade box with total resistance lower than 1K must be connected in place of the RTD as indicated on the connection diagram below **before the instrument is powered up**. If at any instant the instrument was powered up without this connection then at least 10 minutes must elapse from the time of restoring this connection before RTD calibration can take place.
- The instrument should be powered up for at least 10 minutes.

Before using or verifying RTD calibration:

- The mV range must be calibrated first.

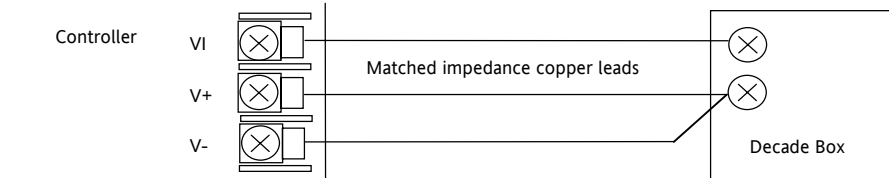







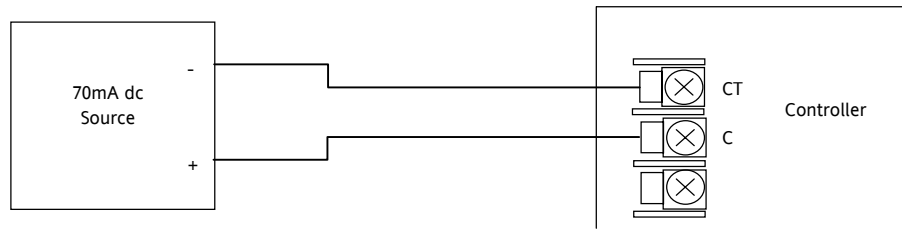









Do This	The Display You Should See	Additional Notes
1. From any display press as many times as necessary until the 'CAL' page header is displayed.		Scrolling display 'CALIBRATION LIST'
2. Press to select 'PHASE'		Scrolling display 'CALIBRATION PHASE'
3. Set the decade box for 150.00Ω		
4. Press or to choose '150r'		
5. Press to select 'GO'		Scrolling display 'CALIBRATION START'
6. Press or to choose 'YES'	 	The controller automatically calibrates to the injected 150.00Ω input. As it does this the display will show <i>busy</i> then <i>PASS</i> , assuming a successful calibration. If it is not successful then <i>FAIL</i> will be displayed. This may be due to an incorrect input resistance
7. Set the decade box for 400.00Ω		
8. Press or to choose '400r'		
9. Repeat 5 and 6 above to calibrate the high point		The controller will again automatically calibrates to the injected 400.00Ω input. If it is not successful then <i>FAIL</i> will be displayed











12.3.4 CT Calibration

To calibrate the current transformer input, connect the current transformer to terminals CT and C.



Do This	The Display You Should See	Additional Notes
1. From the 'CAL' list header press  to select 'PHASE' 2. Press  or  to choose 'CT 0'		Scrolling display 'CALIBRATION PHASE'
3. Adjust the CT for no current applied to the input		
4. Press  to select 'GO' 5. Press  or  to 'YES'	  	Scrolling display 'CALIBRATION START' The controller automatically calibrates to the zero current input. As it does this the display will show <i>busy</i> then <i>PASS</i> , assuming a successful calibration. If it is not successful then 'FAIL' will be displayed. This may be due to an incorrect input current
6. Press  or  to choose 'CT 70'		
7. Adjust the CT for a current of 70mA dc		
8. Press  to select 'GO' 9. Press  or  to 'YES'		The controller again automatically calibrates to 70mA If it is not successful then 'FAIL' will be displayed

12.3.5 To Return to Factory Calibration

Do This	The Display You Should See	Additional Notes
1. From the 'CAL' list header press  to select 'PHASE'		
2. Press  or  to choose 'FACT'		
3. Press  to select 'GO'		The controller automatically returns to the factory values stored during manufacture
4. Press  or  to choose 'YES'		

12.4 Calibration Parameters

The following table lists the parameters available in the Calibration List.

CALIBRATION PARAMETER LIST		'CAL'				
Name	Scrolling Display	Parameter Description	Value		Default	Access Level
PHASE	CAL PHASE	To calibrate low and high offset	none	Not selected		
			0	Select mV low calibration point		
			50	Select mV high calibration point		
			150r	Select PRT low cal point		
			400r	Select PRT high cal point		
			CJC	Select CJC calibration		
			CT 0	Select CT low cal point		
			CT 70	Select CT high cal point		
FACT	Return to factory settings					
GO		To start the calibration sequence	NO			
			YES	Start		
			buSY	Calibrating		
			PASS	Calibration successful		
			FA, L	Calibration unsuccessful		

13. Configuration Using iTools

iTools is a configuration and monitoring package which will edit, store and 'clone' complete controller configurations.

iTools can be used to configure all the functions of the 3216 controller described in this manual. It is also possible using iTools to configure additional functions such as customised messages and parameter promotion. These features are described in this chapter.

You may also wish to refer to the iTools User Handbook Part No. HA026179 which can be downloaded from www.eurotherm.co.uk for further information on how to install, connect and generally operate iTools.

13.1 Connecting a PC to the Controller

In the 3216 controller this may be done using digital communications port H or by a configuration clip.

13.1.1 Using the H Communications Port

Connect the controller to the RS232 serial comms port of the PC shown in the diagram below.

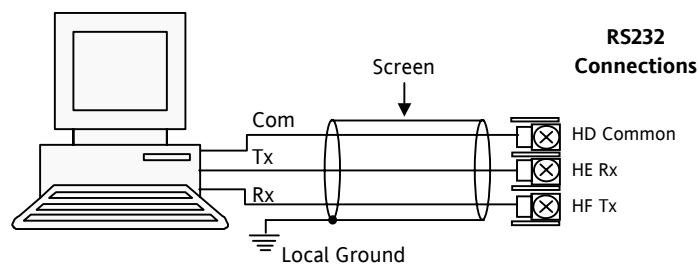

13.1.2 Configuration Clip

A Configuration Clip is available from Eurotherm which can be fitted into the side of a controller as shown below.



The benefit of using this arrangement is that it is not necessary to power the controller, since the clip provides the power to the internal memory of the controller.

13.2 Starting iTools

Open iTools and, with the controller connected, press  on the iTools menu bar. iTools will search the communications ports and TCPIP connections for recognisable instruments. Controllers connected with the configuration clip (CPI), will be found at address 255 regardless of the address configured in the controller.

In the following pages it is assumed that the user is familiar with these instructions and has a general understanding of Windows.

13.3 Configuring a Function

When the instrument is detected a screen view similar to the one shown below will be displayed. The browser on the left shows the List Headers. Open the parameter lists either by double clicking the Header or pressing 'Parameter Explorer' when the list header is selected.

The instrument view may be turned on or off using the 'View' menu and selecting 'Panel Views'.

13.3.1 Example: To Configure an Alarm

The procedure is the same for all functions.

1. Press  to put the controller into Configuration level
2. Select the list header from the browser – in this case 'ALARM' '1'
3. To configure 'Alarm Type' open the drop down under 'Value'
3. Select the alarm type – in this example HI. (1) is the enumeration of the value.
4. Select and set all other parameters using the same procedure

Address	Value
13	NONE (0)
294	HI (1)
47	LO (2)
540	D.HI (3)
544	D.LO (4)
	BND (5)

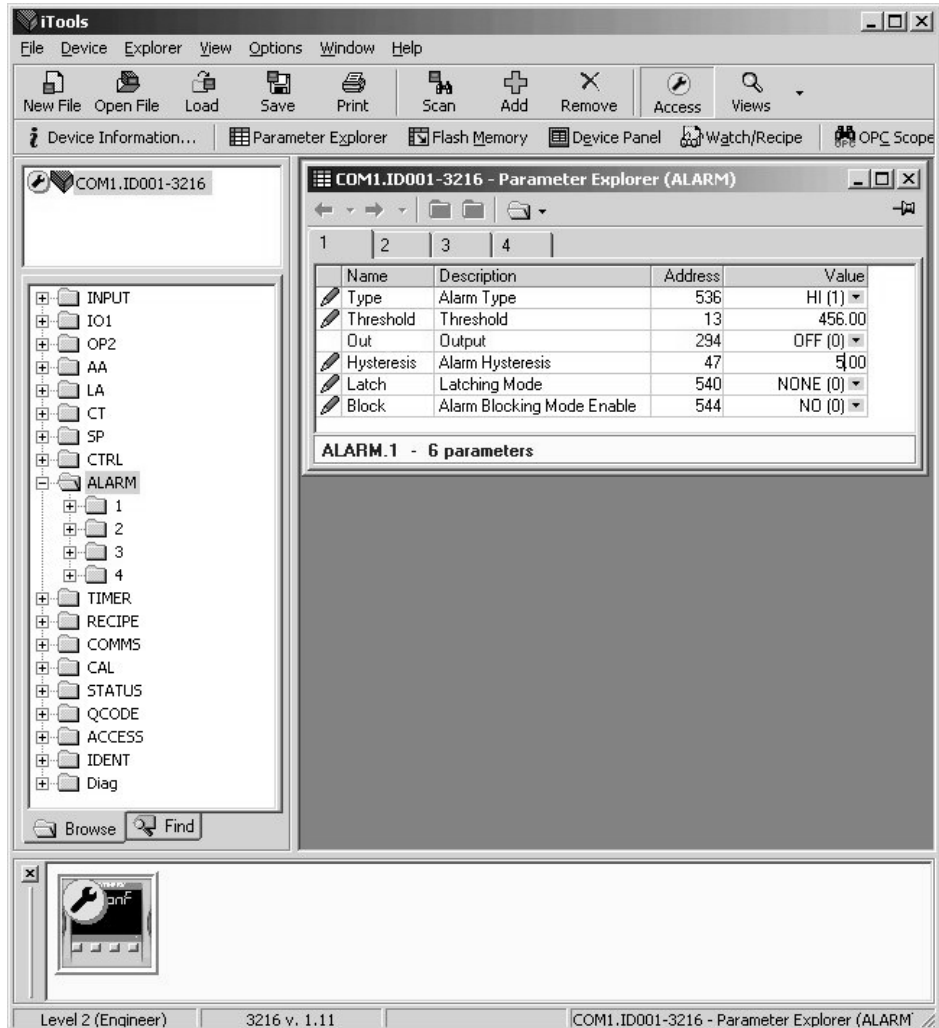



13.4 To Customise Messages

The message which scrolls across the controller display during normal operation may be customised using iTools to show a message which is more meaningful to the user.

13.4.1 Example: To Customise Alarm 1 Message

In this example the alarm 1 message will read 'TOO HOT'.

1. Press  Flash Memory and select the 'Memory Table' tab
2. Select Parameter 'ALARM1 #1'
3. In the 'Message Condition' area change 'Message' to TOO HOT
4. Press  'Update Device Flash Memory' button

In the example shown below Alarm 2 message has also been configured to 'TOO COLD'

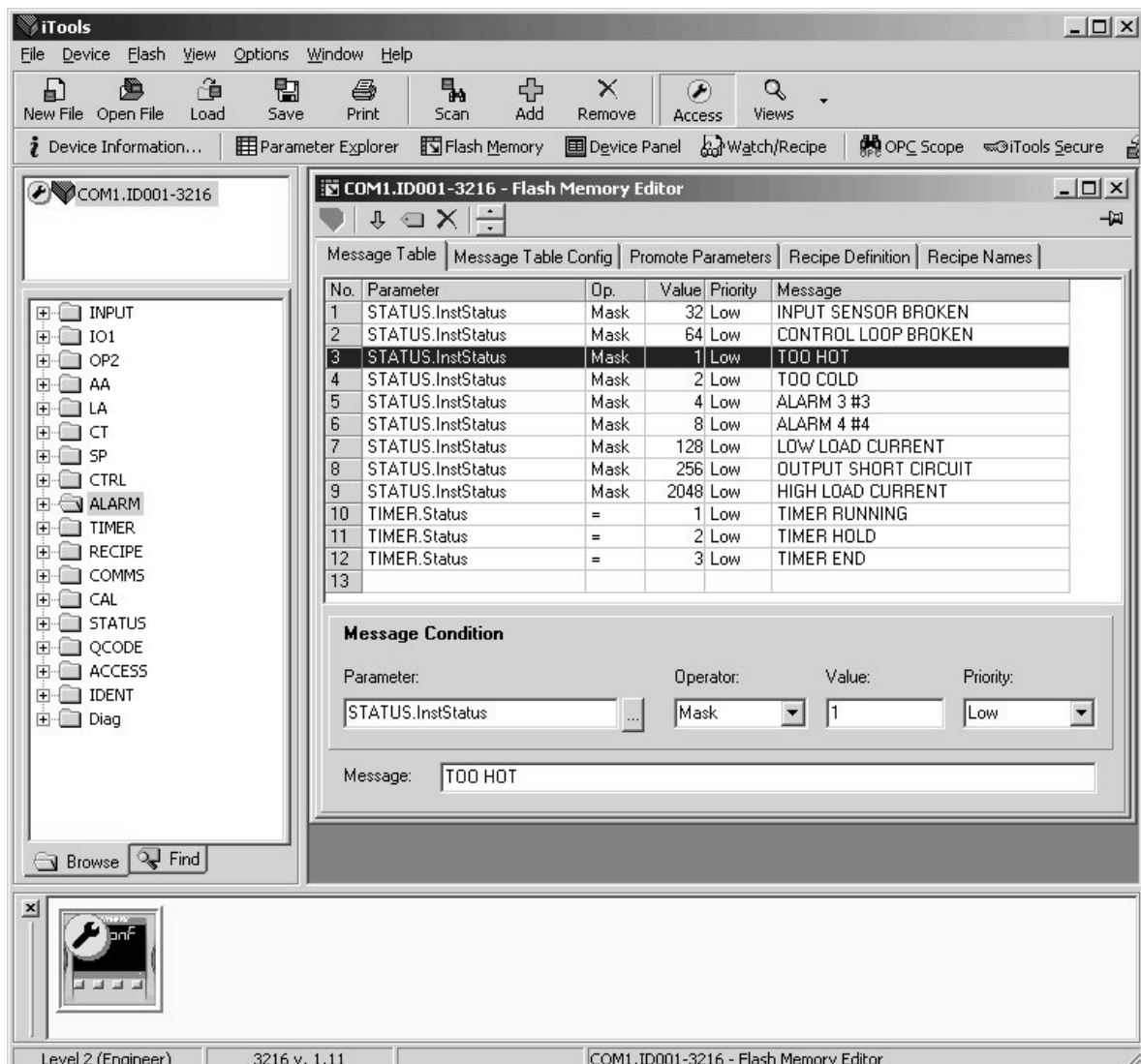

The screenshot shows the iTools interface with the 'Flash Memory Editor' window open. The 'Message Table' tab is selected, displaying the following table:

No.	Parameter	Op.	Value	Priority	Message
1	STATUS.InstStatus	Mask	32	Low	INPUT SENSOR BROKEN
2	STATUS.InstStatus	Mask	64	Low	CONTROL LOOP BROKEN
3	STATUS.InstStatus	Mask	1	Low	TOO HOT
4	STATUS.InstStatus	Mask	2	Low	TOO COLD
5	STATUS.InstStatus	Mask	4	Low	ALARM 3 #3
6	STATUS.InstStatus	Mask	8	Low	ALARM 4 #4
7	STATUS.InstStatus	Mask	128	Low	LOW LOAD CURRENT
8	STATUS.InstStatus	Mask	256	Low	OUTPUT SHORT CIRCUIT
9	STATUS.InstStatus	Mask	2048	Low	HIGH LOAD CURRENT
10	TIMER.Status	=	1	Low	TIMER RUNNING
11	TIMER.Status	=	2	Low	TIMER HOLD
12	TIMER.Status	=	3	Low	TIMER END
13					



Below the table, the 'Message Condition' section is visible, showing the configuration for the selected row (No. 3):

Parameter: STATUS.InstStatus Operator: Mask Value: 1 Priority: Low

Message: TOO HOT

13.4.2 Example 2

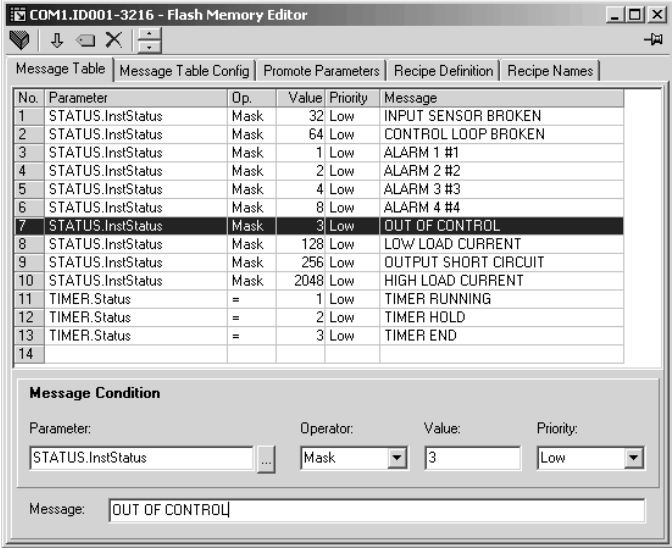
Display the message 'OUT OF CONTROL' if both Alarm 1 and Alarm 2 are active.

Operation	Action	Indication
<p>Add a parameter</p>	<ol style="list-style-type: none"> Right click where the parameter is required Select 'Insert Item' Choose the parameter from the pop up box eg 'STATUS InstStatus' 	
<p>Set the Operator</p>	<ol style="list-style-type: none"> From the Operator drop down box select 'Mask' <p>Note Alternatively a message may be configured to appear if the enumeration of the parameter:- = equals the 'Value' != is not equal to the 'Value' > is greater than the 'Value' < is less than the 'Value'</p>	
<p>Set the value</p> <p>The bitmap list is given here and in the Digital Comms chapter</p>	<ol style="list-style-type: none"> Click in the 'Value' box and press enter From the pop up box either tick the bit field values or type in the decimal equivalent in 'New Value'. In this example 3. 	<p>Instrument Status - Bitmap</p> <ul style="list-style-type: none"> B0 – Alarm 1 Status B1 – Alarm 2 Status B2 – Alarm 3 Status B3 – Alarm 4 Status B4 – Auto/Manual Status B5 – Sensor Break Status B6 – Loop Break Status B7 – CT Low load current alarm status B8 – CT High leakage current alarm status B9 – Program End B10 – PV Overrange (by > 5% of span) B11 – CT Overcurrent alarm status B12 – New Alarm Status B13 – Timer/Ramp Running B14 – Remote Fail, New Alarm B15 – Autotune Status <p>In each case, a setting of 1 signifies 'Active', 0 signifies 'Inactive'.</p>
<p>Set the priority</p>	<ol style="list-style-type: none"> From the drop down select Low Medium or High 	
<p>Enter the message</p>	<ol style="list-style-type: none"> In the message section enter OUT OF CONTROL 	
<p>Download to the controller</p>	<ol style="list-style-type: none"> Press  'Update Device Flash Memory' button 	

Using the Bitmap field above, any alarm message can be displayed for any combination of the alarms in the list.

13.5 To Promote Parameters

The list of parameters which are available in operator levels 1 or 2 can be changed using iTools.

13.5.1 Example: To Change Parameters in the Operator Lists

In this example the parameter 'OP2.Sense' is added to the to the Level 2 list.

1. Press and select the Memory Table tab
2. Select the 'Promote Parameters' tab
3. Highlight the position where you want the new parameter to be placed
4. Press button and from the pop up window select the required parameter. Alternatively use the button.
5. In the Level box select Level 2 (or Level 1 + 2 if it is required to display this parameter in Level 1 as well)
6. In the Access box select 'Read Only' or 'Read/Write' as required
7. Press to remove a selected parameter
8. Press 'Update Device Flash Memory' button

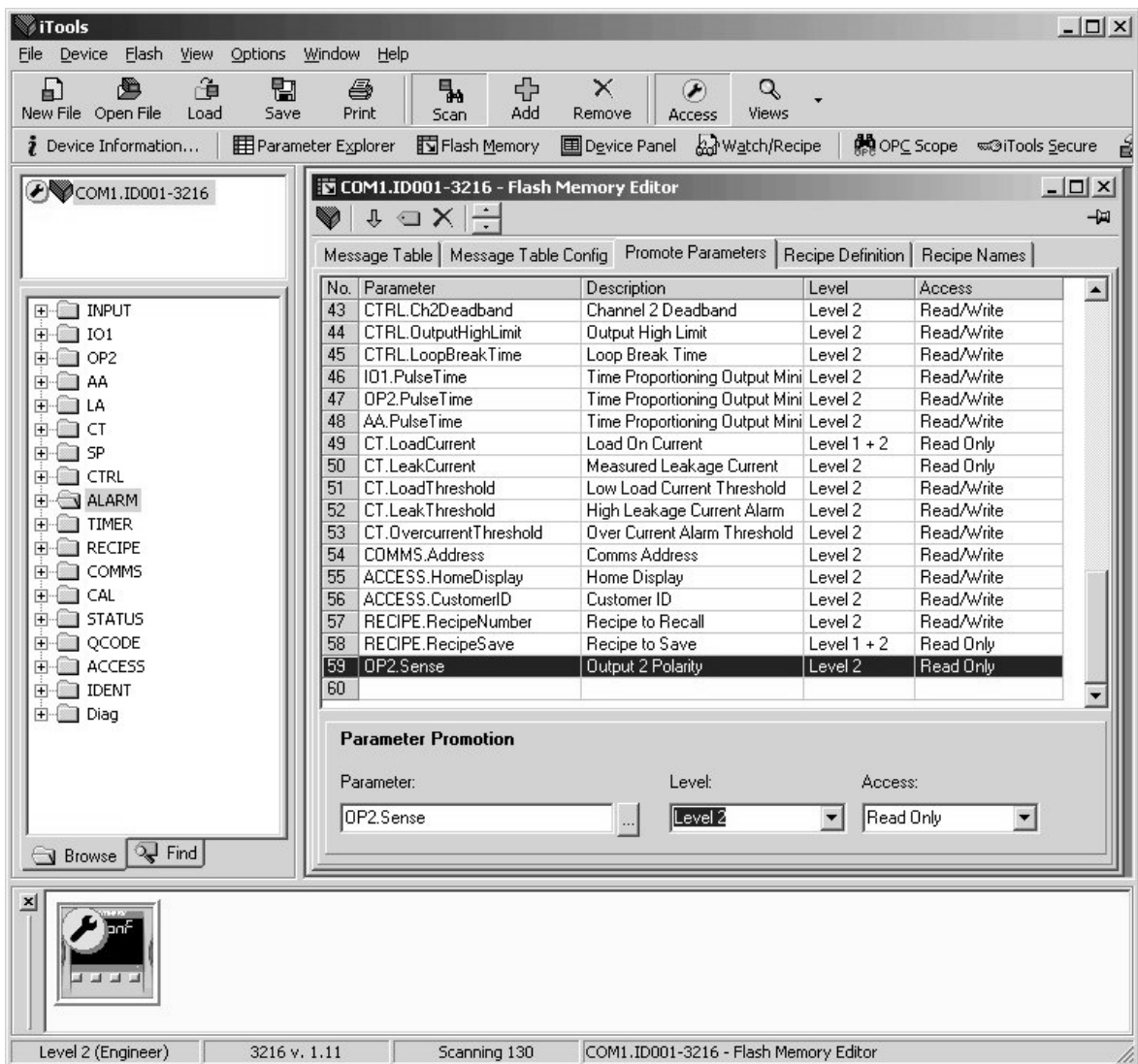

13.6 Cloning

The cloning feature allows the configuration and parameter settings of one instrument to be copied into another. Alternatively a configuration may be saved to file and this used to download to connected instruments. The feature allows new instruments to be rapidly set up using a known reference source or standard instrument. Every parameter and parameter value is downloaded to the new instrument which means that if the new instrument is used as a replacement it will contain exactly the same information as the original. Cloning is generally only possible if the following applies:

- The target instrument has the same hardware configuration as the source instrument
- The target instrument firmware (ie. Software built into the instrument) is the same as or a later version than that of the source instrument. The instrument firmware version is displayed on the instrument when power is applied.
- Generally, cloning will copy all operational, engineering and configuration parameters that are writable.
The communications address is not copied.

Every effort has been made to ensure that the information contained within the clone files is a replica of that configured in the instrument. It is the users responsibility to ensure that the information cloned from one instrument to another is correct for the process to be controlled, and that all parameters are correctly replicated into the target instrument.

Below is a brief description of how to use this feature. Further details are available in the iTools Handbook

13.6.1 Save to File

The configuration of the controller made in the previous sections may be saved as a clone file. This file can then be used to download the configuration to further instruments.

From the File menu use 'Save to File' or use the 'Save' button on the Toolbar.

13.6.2 To Clone a New Controller

Connect the new controller to iTools and Scan to find this instrument as described at the beginning of this chapter.

From the File menu select 'Load Values From File' or select 'Load' from the toolbar. Choose the required file and follow the instruction. The new instrument will be configured to this file.

13.6.3 To Clone Directly from One Controller to Another

Connect the second controller to iTools and scan for the new instrument

From the File menu select 'Send to Device'. Select the controller to be cloned and follow the instructions. The old instrument will be configured the same as the new one.

14. Appendix A SAFETY and EMC INFORMATION

This controller is intended for industrial temperature and process control applications when it will meet the requirements of the European Directives on Safety and EMC. Use in other applications, or failure to observe the installation instructions of this handbook may impair safety or EMC. The installer must ensure the safety and EMC of any particular installation.

Safety

This controller complies with the European Low Voltage Directive 73/23/EEC, by the application of the safety standard EN 61010.

Electromagnetic compatibility

This controller conforms with the essential protection requirements of the EMC Directive 89/336/EEC, by the application of a Technical Construction File. This instrument satisfies the general requirements of the industrial environment defined in EN 61326. For more information on product compliance refer to the Technical Construction File.

GENERAL

The information contained in this manual is subject to change without notice. While every effort has been made to ensure the accuracy of the information, your supplier shall not be held liable for errors contained herein.

Unpacking and storage

The packaging should contain an instrument mounted in its sleeve, two mounting brackets for panel installation and an Installation & Operating guide. Certain ranges are supplied with an input adapter.

If on receipt, the packaging or the instrument are damaged, do not install the product but contact your supplier. If the instrument is to be stored before use, protect from humidity and dust in an ambient temperature range of -30°C to +75°C.

SERVICE AND REPAIR

This controller has no user serviceable parts. Contact your supplier for repair.

Caution: Charged capacitors

Before removing an instrument from its sleeve, disconnect the supply and wait at least two minutes to allow capacitors to discharge. It may be convenient to partially withdraw the instrument from the sleeve, then pause before completing the removal. In any case, avoid touching the exposed electronics of an instrument when withdrawing it from the sleeve.

Failure to observe these precautions may cause damage to components of the instrument or some discomfort to the user.

Electrostatic discharge precautions

When the controller is removed from its sleeve, some of the exposed electronic components are vulnerable to damage by electrostatic discharge from someone handling the controller. To avoid this, before handling the unplugged controller discharge yourself to ground.



Cleaning

Do not use water or water based products to clean labels or they will become illegible. Isopropyl alcohol may be used to clean labels. A mild soap solution may be used to clean other exterior surfaces of the product.

INSTALLATION SAFETY REQUIREMENTS

Safety Symbols

Various symbols are used on the instrument, they have the following meaning:

 Caution, (refer to accompanying documents)  Equipment protected throughout by DOUBLE INSULATION

 Helpful hints

Personnel

Installation must only be carried out by suitably qualified personnel.

Enclosure of live parts

To prevent hands or metal tools touching parts that may be electrically live, the controller must be installed in an enclosure.

Caution: Live sensors

The controller is designed to operate with the temperature sensor connected directly to an electrical heating element. However you must ensure that service personnel do not touch connections to these inputs while they are live. With a live sensor, all cables, connectors and switches for connecting the sensor must be mains rated.

Wiring

It is important to connect the controller in accordance with the wiring data given in this guide. Take particular care not to connect AC supplies to the low voltage sensor input or other low level inputs and outputs. Only use copper conductors for connections (except thermocouple inputs) and ensure that the wiring of installations comply with all local wiring regulations. For example in the UK use the latest version of the IEE wiring regulations, (BS7671). In the USA use NEC Class 1 wiring methods.

Power Isolation

The installation must include a power isolating switch or circuit breaker. The device should be mounted in close proximity to the controller, within easy reach of the operator and marked as the disconnecting device for the instrument.

Overcurrent protection

The power supply to the system should be fused appropriately to protect the cabling to the units.

Voltage rating

The maximum continuous voltage applied between any of the following terminals must not exceed 264Vac:

- relay output to logic, dc or sensor connections;
- any connection to ground.

The controller must not be wired to a three phase supply with an unearthed star connection. Under fault conditions such a supply could rise above 264Vac with respect to ground and the product would not be safe.

Conductive pollution

Electrically conductive pollution must be excluded from the cabinet in which the controller is mounted. For example, carbon dust is a form of electrically conductive pollution. To secure a suitable atmosphere, install an air filter to the air intake of the cabinet. Where condensation is likely, for example at low temperatures, include a thermostatically controlled heater in the cabinet.

This product has been designed to conform to BSEN61010 installation category II, pollution degree 2. These are defined as follows:-

Installation Category II

The rated impulse voltage for equipment on nominal 230V supply is 2500V.

Pollution Degree 2

Normally only non conductive pollution occurs. Occasionally, however, a temporary conductivity caused by condensation shall be expected.

Grounding of the temperature sensor shield

In some installations it is common practice to replace the temperature sensor while the controller is still powered up. Under these conditions, as additional protection against electric shock, we recommend that the shield of the temperature sensor is grounded. Do not rely on grounding through the framework of the machine.

Over-Temperature Protection

When designing any control system it is essential to consider what will happen if any part of the system should fail. In temperature control applications the primary danger is that the heating will remain constantly on. Apart from spoiling the product, this could damage any process machinery being controlled, or even cause a fire.

Reasons why the heating might remain constantly on include:

- the temperature sensor becoming detached from the process
- thermocouple wiring becoming short circuit;
- the controller failing with its heating output constantly on

- an external valve or contactor sticking in the heating condition
- the controller setpoint set too high.

Where damage or injury is possible, we recommend fitting a separate over-temperature protection unit, with an independent temperature sensor, which will isolate the heating circuit.

Please note that the alarm relays within the controller will not give protection under all failure conditions.

INSTALLATION REQUIREMENTS FOR EMC

To ensure compliance with the European EMC directive certain installation precautions are necessary as follows:

- For general guidance refer to EMC Installation Guide, HA025464.
- When using relay outputs it may be necessary to fit a filter suitable for suppressing the conducted emissions. The filter requirements will depend on the type of load. For typical applications we recommend Schaffner FN321 or FN612.
- If the unit is used in table top equipment which is plugged into a standard power socket, then it is likely that compliance to the commercial and light industrial emissions standard is required. In this case to meet the conducted emissions requirement, a suitable mains filter should be installed. We recommend Schaffner types FN321 and FN612.

Routing of wires

To minimise the pick-up of electrical noise, the low voltage DC connections and the sensor input wiring should be routed away from high-current power cables. Where it is impractical to do this, use shielded cables with the shield grounded at both ends. In general keep cable lengths to a minimum.

15. Appendix B TECHNICAL SPECIFICATION

Analogue Input

Sample rate	4Hz (250mS)
Calibration accuracy	±0.25% of reading
Resolution	<5, 0.5µV when using a 5 second filter
Linearisation accuracy	<0.1% of reading
Input filter	Off to 59.9 secs
Zero offset	User adjustable over the full display range
Thermocouple Types	Refer to Sensor inputs and display ranges table
Cold junction compensation	Automatic compensation typically >30 to 1 rejection of ambient temperature change or external reference 0°C (32°F)
RTD/PT100 Type	3-wire, Pt100 DIN43760
Bulb current	0.2mA
Lead compensation	No error for 22 ohms in all 3 leads
Process Linear	-10 to 80mV, 0 to 10V with external potential divider module 100KΩ/800
Current transformer	50mAac into 10 ohm. This burden resistor is fitted inside the controller
Fusing	Fit a 2A type T fuse in line with this controller

Digital input

Contact closure or logic	12V @ 5-40mA
Contact open	>500Ω
Contact closed	<200Ω

Outputs

Relay	Rating: 2-pin relay	Min: 12V, 100mA dc Max: 2A, 264Vac resistive
	Rating: change-over, alarm relay	Min: 12V, 100mA dc Max: 2A, 264Vac resistive
	Application	Heating, cooling or alarms
Logic	Rating	On/High 12Vdc at 5 to 44mA Off/Low <100mV <100µA
	Application	Heating, cooling, alarms or event

Communications (Not 3116)

Digital	Transmission standard	EIA-485 2wire or EIA-232 at 1200, 2400, 4800, 9600, 19,200 baud
	Protocols	Modbus®

Control functions

Control	Modes	PID or PI with overshoot inhibition, PD, PI, P only or On/Off
	Application	Heating and cooling
	Auto/manual	Bumpless transfer
	Setpoint rate limit	Off to 9999 degrees or display units per minute
Tuning	One-shot tune	Automatic calculation of PID and overshoot inhibition parameters
Alarms	Types	Full scale high or low. Deviation high, low, or band
	Modes	Latching or non-latching. Normal or blocking action Up to four process alarms can be combined onto a single output

Current Transformer Input

Input current	0 to 50mA rms calibrated, 50/60Hz
Scale	0 to 10, 25, 50 or 100Amps
Input impedance	<20Ω
Accuracy	±4% of reading
Alarms	Leakage current, overcurrent

Alarms

Indication	Custom scrolling message and beacon
Types	High, low, deviation band, sensor fault, load leakage current, over current, internal events

Recipes

Number	5
Parameters stored	38
Selection	Key press or via remote communications

General

Text Messages	10 x 30 character messages
Dimensions and weight	48W x 48H x 90Dmm (1.89W x 1.89H x 3.54D in) 8.82oz (250g)
Power Supply	110 to 240Vac -15%, +10%. 48 to 62Hz. 5 watts max
Temperature and RH	Operating: 32 to 131°F (0 to 55°C), RH: 5 to 90% non-condensing. Storage: 14 to 158°F (-10 to 70°C)
Panel sealing	IP 65, plug-in from front panel Safety standards EN61010, installation category 2 (voltage transients must not exceed 2.5kV)
Electromagnetic compatibility	EN61326-1 Suitable for domestic, commercial and light industrial as well as heavy industrial environments. (Class B emissions, Industrial Environment immunity).

Index

- Access Parameters, 1, 27
- Acknowledge, 2, 10, 56, 89, 92, 93
- ADDR, 20, 83, 86, 88
- Address, 3, 83, 86, 88
- AL1, 27, 36, 39, 40
- AL2, 36, 39, 40
- AL3, 36, 39, 40
- AL4, 36, 39, 40
- Alarm, 1, 2, 3, 4, 10, 13, 15, 17, 22, 24, 27, 35, 36, 39, 40, 41, 42, 54, 55, 56, 57, 58, 59, 60, 80, 86, 87, 88, 89, 90, 91, 93, 104, 105
- Alarm Relay, 2, 56
- A-M, 51, 63, 89
- Auto, 1, 10, 15, 16, 18, 20, 27, 28, 31, 37, 39, 42, 47, 48, 50, 51, 55, 58, 59, 60, 62, 63, 87, 88, 89, 92, 93, 111
- BAUD, 83, 92
- Block Diagram, 1, 29
- Calibration, 4, 33, 61, 88, 90, 91, 96, 97, 98, 99, 100, 101, 102, 111
- CLr, 21, 27
- COLD, 27, 105
- CONF.P, 27
- Configuration, 1, 4, 12, 14, 22, 23, 27, 31, 34, 96, 103, 104
- Control Action, 2, 49, 52, 53, 66, 86
- Cool, 36, 39, 40
- CT, 4, 6, 10, 13, 17, 20, 21, 26, 29, 35, 36, 39, 40, 41, 42, 43, 87, 91, 93, 97, 101, 102
- Ct.AL, 36, 39, 40
- Current Transformer, 1, 2, 10, 35, 42, 43, 54, 93, 97, 111
- cutback, 2, 46, 47, 48
- Derivative Time, 46, 48, 86
- Dimensions, 1, 5, 112
- Display Mnemonic
 - 1.D.IN, 36, 93
 - 1.FUNC, 36, 38
 - 1.PLS, 37, 94
 - 1.SENS, 37, 94
 - 1.SRC.A, 36, 38, 93
 - 1.SRC.B, 36, 38, 94
 - 1.SRC.C, 36, 38, 94
 - 1.SRC.D, 36, 38, 94
 - 2.FUNC, 39, 94
 - 2.PLS, 39, 94
 - 2.SENS, 39, 94
 - 2.SRC.A, 39, 94
 - 2.SRC.B, 39, 94
 - 2.SRC.C, 39, 94
 - 2.SRC.D, 39, 94
 - 4.FUNC, 40, 94
 - 4.PLS, 40, 95
 - 4.SENS, 40, 95
 - 4.SRC.A, 40, 95
 - 4.SRC.B, 40, 95
 - 4.SRC.C, 40, 95
 - 4.SRC.D, 40, 95
- 4.TYPE, 40, 94
- A1.--, 20, 59, 60, 86
- A1.BLK, 59, 91
- A1.HYS, 59, 87
- A1.LAT, 59, 90
- A1.TYP, 25, 59, 60, 90
- Ac.AL, 36, 41
- ADDR, 20, 83, 86, 88
- AL1, 27, 36, 39, 40
- AL2, 36, 39, 40
- AL3, 36, 39, 40
- AL4, 36, 39, 40
- ATUNE, 50
- Auto, 1, 10, 15, 16, 18, 20, 27, 28, 31, 37, 39, 42, 47, 48, 50, 51, 55, 58, 59, 60, 62, 63, 87, 88, 89, 92, 93, 111
- b.tc, 32
- BAUD, 83, 92
- CAL, 33, 96, 98, 100, 101, 102
- CJC, 31, 88, 91, 92, 97, 99, 102
- Conf, 22, 23, 27, 31, 33, 34, 36, 37, 39, 40, 41, 42, 44, 50, 59, 61, 76, 83, 90
- CT, 4, 6, 10, 13, 17, 20, 21, 26, 29, 35, 36, 39, 40, 41, 42, 43, 87, 91, 93, 97, 101, 102
- Ct.AL, 36, 39, 40
- CT.L, 42, 93
- CT.LAT, 42, 93
- CT.RNG, 42, 91
- CT.SRC, 42, 93
- CTRL.A, 50, 53, 86
- CTRL.C, 50, 89
- CTRL.H, 50, 89
- D.BAND, 20, 50, 87
- d.in, 36, 41, 78
- d.Out, 36, 37, 39, 40
- d.OUt, 40
- DEC.P, 31, 90
- DELAY, 83, 93
- Dwell, 3, 13, 19, 62, 63, 64, 66, 72, 75, 76, 80, 89
- ENT.T, 76
- FILT.T, 31, 88
- Heat, 13, 20, 35, 36, 39, 40, 42, 77, 78, 89, 93, 94
- HYST.C, 20, 51, 88
- HYST.H, 20, 50, 53, 88
- I/O-1, 35
- IN.TYP, 31, 92
- J.tc, 32
- k.tc, 32
- L.io, 36
- LOP, 39
- L.tc, 32
- Lbr, 36, 39, 40
- LEV 1, 23
- LEV 2, 23
- LEV 3, 23
- Lev.1, 27
- Lev.2, 27

Lev.3, 27
 Loc.b, 36, 41
 mAn, 16, 36, 39, 40
 Man, 27, 36, 41, 51, 55, 59, 60
 n.tc, 32
 none, 19, 21, 27, 31, 36, 39, 40, 41, 42, 55, 59,
 60, 76, 77, 78, 83, 91, 102
 nw.AL, 36, 39, 40
 OFS.HI, 91
 OFS.LO, 91
 OP.HI, 20, 47, 50, 53, 87
 OP.LO, 20, 47, 50, 53, 87
 OP-2, 2, 35, 39, 42
 PB.UNT, 50, 53, 90
 PNT.HI, 91
 PNT.LO, 91
 PRTY, 83, 93
 PV.OFS, 31, 88
 r.tc, 32
 REC.NO, 21, 89
 reLy, 39, 40
 ReLy, 36
 RNG.HI, 31, 86
 RNG.LO, 31, 86
 Rtd, 32
 RTD, 4, 9, 13, 30, 31, 34, 92, 97, 100, 111
 S.tc, 32
 Sbr, 30, 36, 39, 40
 SP.HI, 18, 19, 20, 44, 88
 SP.LO, 18, 19, 20, 44, 45, 88
 SP.RAT, 3, 18, 19, 44, 45, 67, 87
 SP.SEL, 44, 87
 SP1, 3, 17, 18, 19, 32, 44, 45, 62, 63, 64, 65, 66,
 67, 68, 69, 71, 76, 87, 92, 93
 SP2, 3, 15, 18, 19, 32, 36, 41, 44, 45, 62, 65, 66,
 67, 68, 72, 73, 74, 75, 76, 87
 SS.PWR, 19, 71, 76, 89
 SS.SP, 19, 71, 76, 89
 STORE, 21, 79
 T.ELAP, 66, 68, 70, 72, 76, 89
 t.end, 77
 t.End, 36, 39, 40, 70, 72
 t.HLd, 36, 41
 T.REMN, 17, 19, 66, 68, 70, 72, 76, 89
 t.res, 36, 41
 t.rrS, 36, 41
 t.run, 36, 39, 40, 41, 70, 72, 78
 T.STAT, 18, 62, 69, 71, 74, 76, 87
 t.tc, 32
 TC, 30
 THRES, 19, 63, 68, 75, 76, 89
 TM.CFG, 19, 75, 76, 89
 TM.res, 76
 TM.RES, 19, 75, 89
 UNITS, 18, 31, 44, 50, 90
 WKG.SP, 17, 18, 86
 Fault detection, 30
 GOTO, 27
 Heat, 13, 20, 35, 36, 39, 40, 42, 77, 78, 89, 93, 94
 High Cutback, 46, 48
 HOME, 1, 14, 15, 16, 18, 21, 23, 25, 27, 44, 68
 Hysteresis, 2, 52, 55, 87, 88
 ID, 21, 27, 83, 86, 91, 92, 93, 94
 Inductive Loads, 9
 input, 6, 9, 10, 11, 12, 16, 20, 29, 30, 31, 32, 33, 34,
 36, 37, 41, 42, 43, 44, 46, 61, 62, 69, 70, 71, 72,
 76, 77, 78, 88, 92, 93, 94, 96, 98, 99, 100, 101,
 108, 109, 110, 111
 Input filter, 30, 31, 111
 Input Type
 Type mV, 4, 31, 32, 34, 92, 97, 98, 99, 100, 102
 Input Type and linearisation, 30
 Input/Output, 1, 2, 9, 13, 35, 36
 Installation, 1, 5, 7, 108, 109, 110
 Integral, 2, 46, 48, 49, 80, 86
 Integral Time, 46, 48, 86
 Internet Site
 UK, 10
 K.LOC, 27, 92
 L.OP, 39
 Latched Alarms, 56
 Lbr, 36, 39, 40
 LBT, 49, 50, 88
 LEAK, 20, 42, 89
 Lev.1, 27
 Lev.2, 27
 Lev.3, 27
 LEV2.P, 27
 LEV3.P, 27
 LOAD, 17, 20, 42, 89
 Low Cutback, 46, 48
 mAn, 16, 36, 39, 40
 Manual, 1, 2, 6, 10, 13, 15, 16, 18, 27, 28, 36, 39,
 40, 41, 48, 49, 55, 58, 59, 60, 62, 63, 80, 86, 87,
 88, 89, 90, 92, 93
 Modbus, 3, 10, 83, 84, 86, 88, 92, 94, 95, 111
 Mounting, 1, 7
 MR, 20, 49, 50, 87
 Name, 27, 31, 35, 36, 39, 40, 41, 42, 44, 50, 59, 76,
 83, 86, 102
 Non Latched Alarms, 56
 nw.AL, 36, 39, 40
 On/Off Control, 2, 49, 89
 One-shot, 2, 47, 111
 Output Power, 1, 16, 88
 Over/Under range, 30
 PB, 20, 48, 49, 50, 53, 79, 86, 90
 PID, 1, 2, 13, 37, 38, 46, 47, 49, 50, 52, 53, 89, 111
 Power Supply, 1, 11, 112
 Proportional Band, 46, 53, 80, 86, 90
 PRTY, 83, 93
 PV, 1, 2, 9, 13, 16, 19, 20, 29, 30, 31, 33, 34, 44,
 45, 46, 47, 48, 49, 50, 52, 55, 64, 65, 68, 71, 72,
 73, 75, 76, 78, 83, 84, 86, 87, 88
 R2G, 20, 50, 87
 ramp, 18, 19, 45, 62, 67, 68, 73, 75, 86, 87
 Recipe, 3, 13, 79, 80, 89
 Relative Cool Gain, 2, 46, 49
 reLy, 39, 40
 SAFE, 51, 87
 Sbr, 30, 36, 39, 40
 Sby, 36, 41
 Setpoint Parameters, 2, 44

Sleeve, 1, 7
SP, 19, 86
Switch On, 1, 3, 12, 69
t.End, 36, 39, 40, 70, 72
t.run, 36, 39, 40, 41, 70, 72, 78
TD, 20, 50
terminals, 8, 9, 31, 36, 39, 40, 41, 81, 82, 85, 101,
109
Thermocouple
Type b – b.tc, 32
Type J – J.tc, 32
Type k – k.tc, 32
Type L – L.tc, 32
Type n – n.tc, 32
Type r – r.tc, 32
Type S – S.tc, 32
Type t – t.tc, 32
TI, 20, 50
Timer, 3, 10, 15, 19, 28, 29, 36, 39, 40, 41, 62, 63,
66, 68, 69, 70, 71, 72, 73, 75, 76, 77, 78, 80, 87,
88, 89, 92, 93
TIMER, 18, 19, 62, 63, 66, 68, 70, 72, 73, 74, 75,
76
Tuning, 2, 47, 48, 111
User calibration, 30
Wiring, 1, 2, 3, 8, 11, 43, 81, 85, 109

INTERNATIONAL SALES AND SERVICE

AUSTRALIA Sydney
Eurotherm Pty. Ltd.
Telephone (+61 2) 9838 0099
Fax (+61 2) 98389288

AUSTRIA Vienna
Eurotherm GmbH
Telephone (+43 1) 7987601
Fax (+43 1) 7987605

BELGIUM Moha &
LUXEMBURG Huy
Eurotherm S.A./N.V.
Telephone (+32) 85 274080
Fax (+32) 85 274081

BRAZIL Campinas-SP
Eurotherm Ltda.
Telephone (+55 19) 3237 3413
Fax (+55 19) 3234 7050

DENMARK Copenhagen
Eurotherm Danmark A/S
Telephone (+45 70) 234670
Fax (+45 70) 234660

FINLAND ABO
Eurotherm Finland
Telephone (+358) 22506030
Fax (+358) 22503201

FRANCE Lyon
Eurotherm Automation SA
Telephone (+33 478) 664500
Fax (+33 478) 352490

GERMANY Limburg
Eurotherm Deutschland GmbH
Telephone (+49 6431) 2980
Fax (+49 6431) 298119
Also regional offices

HONG KONG Aberdeen
Eurotherm Limited
Telephone (+852) 28733826
Fax (+852) 28700148

INDIA Chennai
Eurotherm India Limited
Telephone (+9144) 4961129
Fax (+9144) 4961831

IRELAND Dublin
Eurotherm Ireland Limited
Telephone (+353 01) 4691800
Fax (+353 01) 4691300

ITALY Como
Eurotherm S.r.l
Telephone (+39 031) 975111
Fax (+39 031) 977512

KOREA Seoul
Eurotherm Korea Limited
Telephone (+82 31) 2868507
Fax (+82 31) 2878508

NETHERLANDS Alphen a/d Ryn
Eurotherm B.V.
Telephone (+31 172) 411752
Fax (+31 172) 417260

NORWAY Oslo
Eurotherm A/S
Telephone (+47 67) 592170
Fax (+47 67) 118301

SPAIN Madrid
Eurotherm España SA
Telephone (+34 91) 6616001
Fax (+34 91) 6619093

SWEDEN Malmo
Eurotherm AB
Telephone (+46 40) 384500
Fax (+46 40) 384545

SWITZERLAND Freienbach
Eurotherm Produkte (Schweiz) AG
Telephone (+41 55) 4154400
Fax (+41 55) 4154415

UNITED KINGDOM Worthing
Eurotherm Limited
CONTROLS &
DATA MANAGEMENT
Telephone (+44 1903) 695888
Fax (+44 1903) 695666
PROCESS AUTOMATION
Telephone (+44 1903) 205277
Fax (+44 1903) 236465

U.S.A Leesburg
Eurotherm Inc.
Telephone (+1 703) 443 0000
Fax (+1 703) 669 1300
Web www.eurotherm.com

ED 36

© Copyright Eurotherm Limited 2004

All rights are strictly reserved. No part of this document may be reproduced, modified, or transmitted in any form by any means, nor may it be stored in a retrieval system other than for the purpose to act as an aid in operating the equipment to which the document relates, without the prior written permission of Eurotherm limited.

Eurotherm Limited pursues a policy of continuous development and product improvement. The specifications in this document may therefore be changed without notice. The information in this document is given in good faith, but is intended for guidance only. Eurotherm Limited will accept no responsibility for any losses arising from errors in this document.

