



Diffuse Reflectance IR and UV-vis Spectroscopy

Modern Methods in Heterogeneous Catalysis

Friederike Jentoft

December 10, 2004

Outline

I. Background

1. UV-vis, NIR and IR spectroscopy
2. Transmission
3. Specular & Diffuse Reflectance
4. Mie and Rayleigh Scattering Theories
5. Kubelka-Munk Theory

II. Experimental & Examples

1. White Standards
2. Integrating Spheres
3. Mirror Optics
4. Fiber Optics

UV- vis- NIR – MIR

Art des Übergangs		Molekül-Rotation			Molekül-schwingung			Elektronen-anregung					
Spektroskopische Methode		Mikrowellen-Absorption			Infrarot-Spektroskopie			UV- / Vis-Spektroskopie					
Spektralbereich		Radiowellen		Mikrowellen		Infrarot (IR)			Vis	UV	Röntgenstrahlen		
						F	M	N					
Wellenlänge [m] $\lambda = \frac{c}{\nu}$	λ	10	1	10 ⁻¹	10 ⁻²	10 ⁻³	10 ⁻⁴	10 ⁻⁵	10 ⁻⁶	10 ⁻⁷	10 ⁻⁸	10 ⁻⁹	10 ⁻¹⁰
					1 cm				1 μm			1 nm	1 Å
Frequenz [Hz] $\nu = \frac{c}{\lambda} = c \cdot \tilde{\nu}$	ν	10 ⁻⁷		10 ⁻⁹		10 ⁻¹¹		10 ⁻¹³		10 ⁻¹⁵		10 ⁻¹⁷	
Wellenzahl $\tilde{\nu} = \frac{1}{\lambda} = \frac{\nu}{c}$ [cm ⁻¹]	$\tilde{\nu}$	10 ⁻³		10 ⁻¹		10		10 ³		10 ⁵		10 ⁷	

- ❖ electronic transitions, vibrations (rotations)
- ❖ Diffuse reflectance UV-vis spectroscopy (DR-UV-vis spectroscopy or DRS)
- ❖ Diffuse reflectance Fourier-transform infrared spectroscopy (DRIFTS)

Interaction of Light with Sample

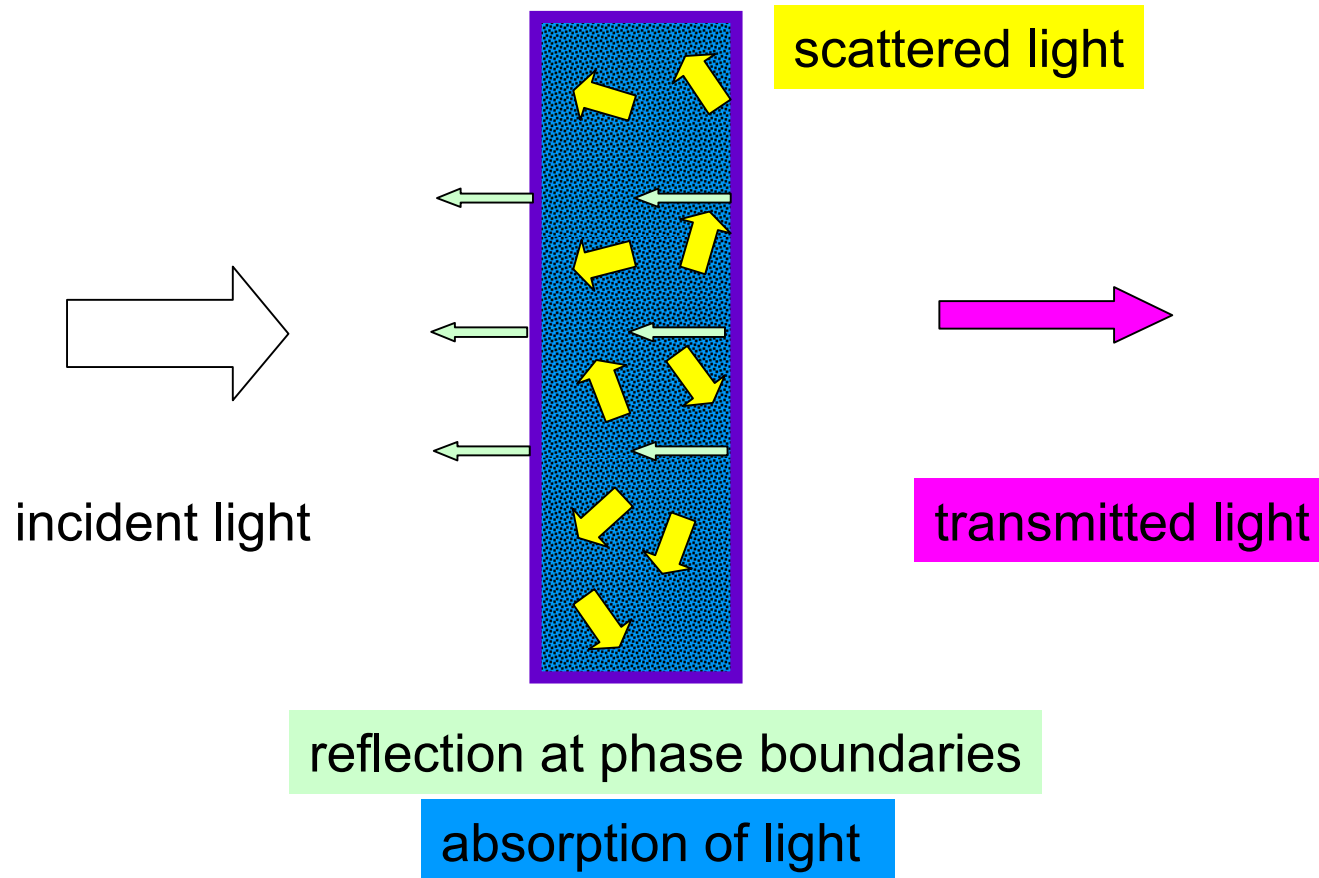

- ❖ how to extract absorbing properties from transmitted light?
- ❖ how to deal with reflection and scattering?

How to Deal with Reflection (1)

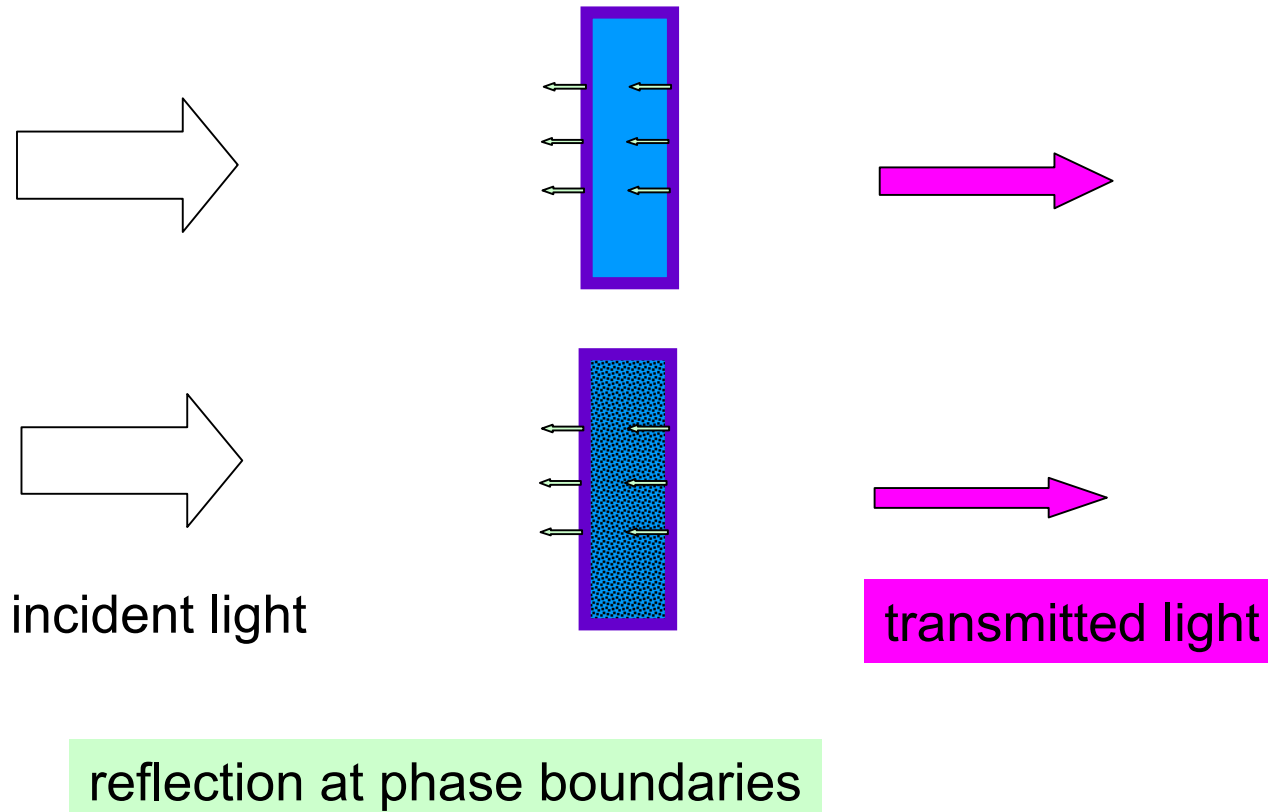

- ❖ fraction of reflected light can be eliminated through reference measurement with same materials (cuvette+ solvent)

How to Deal with Reflection (2)

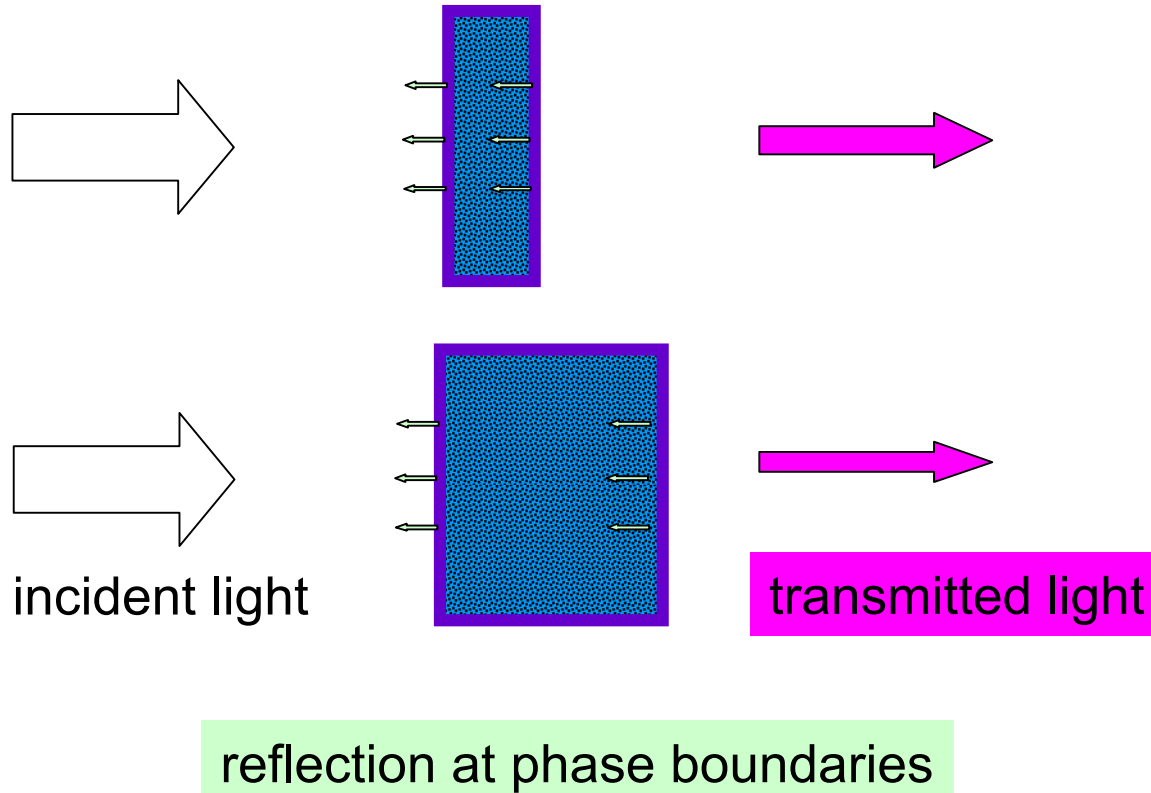

- ❖ fraction of reflected light can be eliminated through variation of sample thickness: number of phase boundaries remains the same

Scattering

- ❖ scattering is negligible in molecular disperse media (solutions)
- ❖ scattering is considerable for colloids and solids when the wavelength is in the order of magnitude of the particle size

	Wavenumber	Wavelength
Mid-IR (MIR)	3300 to 250 cm^{-1}	3 to (25-40) μm
Near-IR (NIR)	12500 to 3300 cm^{-1}	(700-1000) to 3000 nm
UV-vis	50000 to 12500 cm^{-1}	200 to 800 nm

- ❖ scattering is reduced through embedding of the particles in media with similar refractive index: KBr wafer (clear!) technique, immersion in Nujol



Transmittance

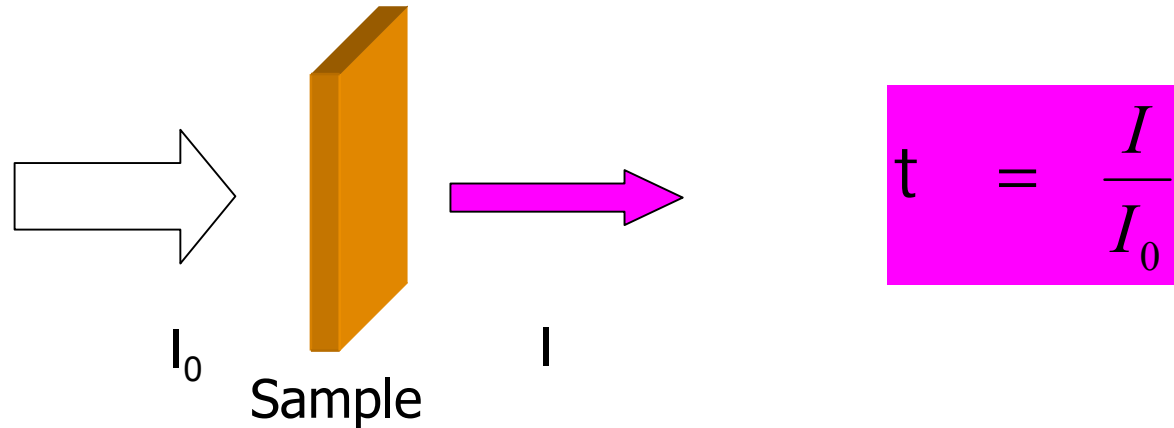

if luminescence and scattering are negligible:

$$1 = \alpha + \tau + \rho$$

α	absorptance, absorption factor, Absorptionsgrad
$\tau(T)$	transmittance, transmission factor, Transmissionsgrad
ρ	reflectance, reflection factor, Reflexionsgrad

if we manage to eliminate reflection:

$$1 = \alpha + \tau$$

in this case, the absorption properties of the sample can be calculated from the transmitted light

Transmitted Light and Sample Absorption Properties

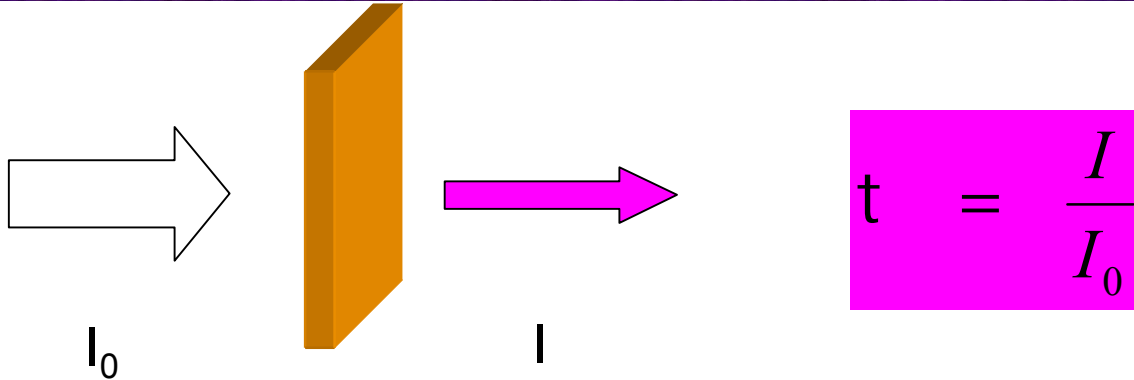

$$dI = -I \kappa c dl$$

decrease of I in an infinitesimally thin layer

c : molar concentration of absorbing species [mol/m^3]

κ : the molar napierian extinction coefficient [m^2/mol]

$$\int_{I_0}^I \frac{dI}{I} = - \int_0^l \kappa c dl$$

separation of variables and integration

sample thickness: l

$$\ln \frac{I}{I_0} = -\kappa c l$$

Transmitted Light and Sample Absorption Properties

$$t = \frac{I}{I_0} = e^{-k c l} = 1 - a$$

Lambert-Beer Law

$$A_e = B = k c l = -\ln(1 - a)$$

napierian absorbance
Napier-Absorbanz

$$A_{10} = e c l = -\log(1 - a)$$

(decadic) absorbance
dekadische Absorbanz
standard spectroscopy
software uses A_{10} !

extinction E (means absorbed + scattered light)

absorbance A (A_{10} or A_e)

optical density O.D.

all these quantities are DIMENSIONLESS !!!!

Limitations of Transmission Spectroscopy

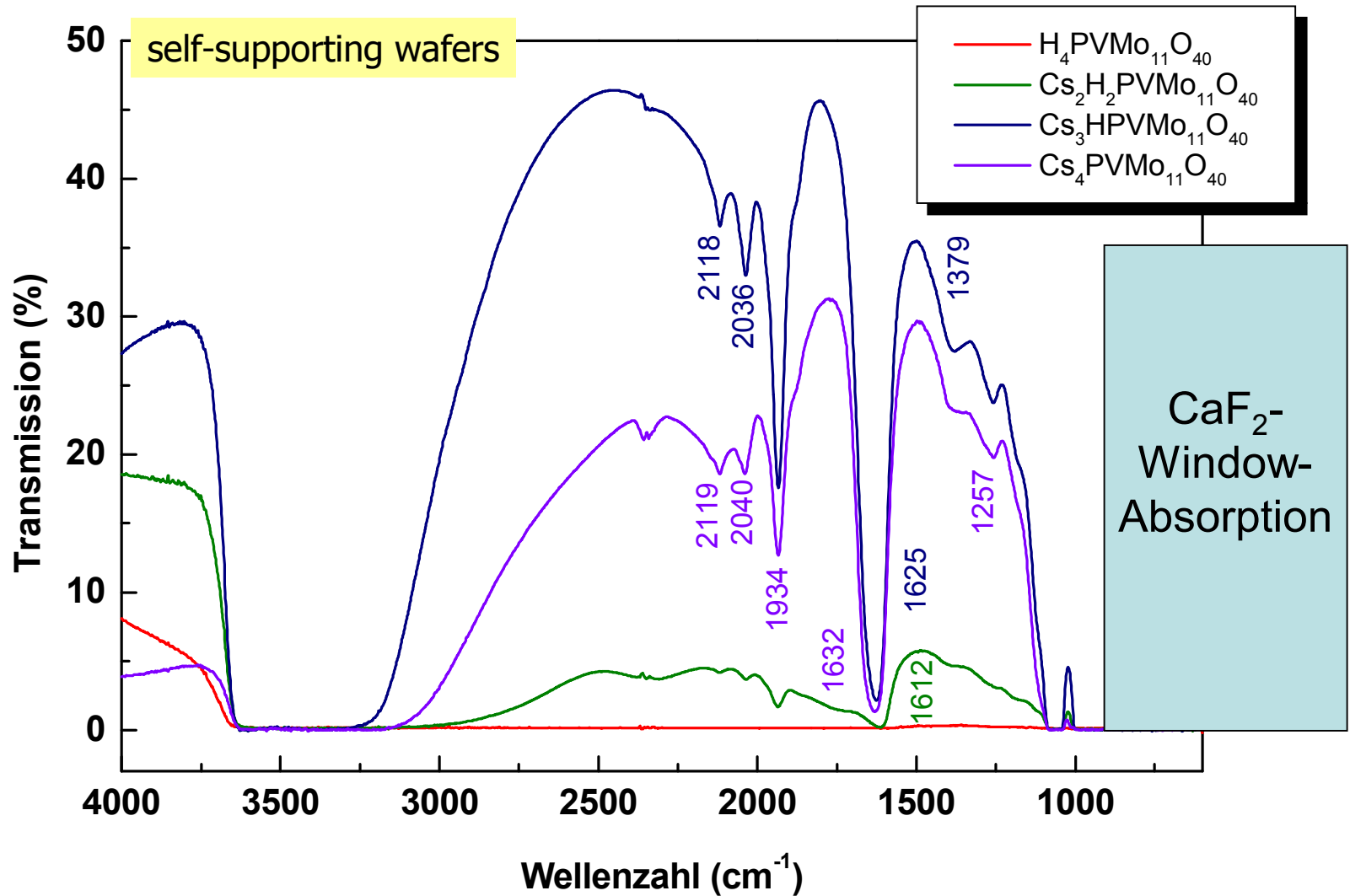

But.....Reaction with Material Used for Embedding

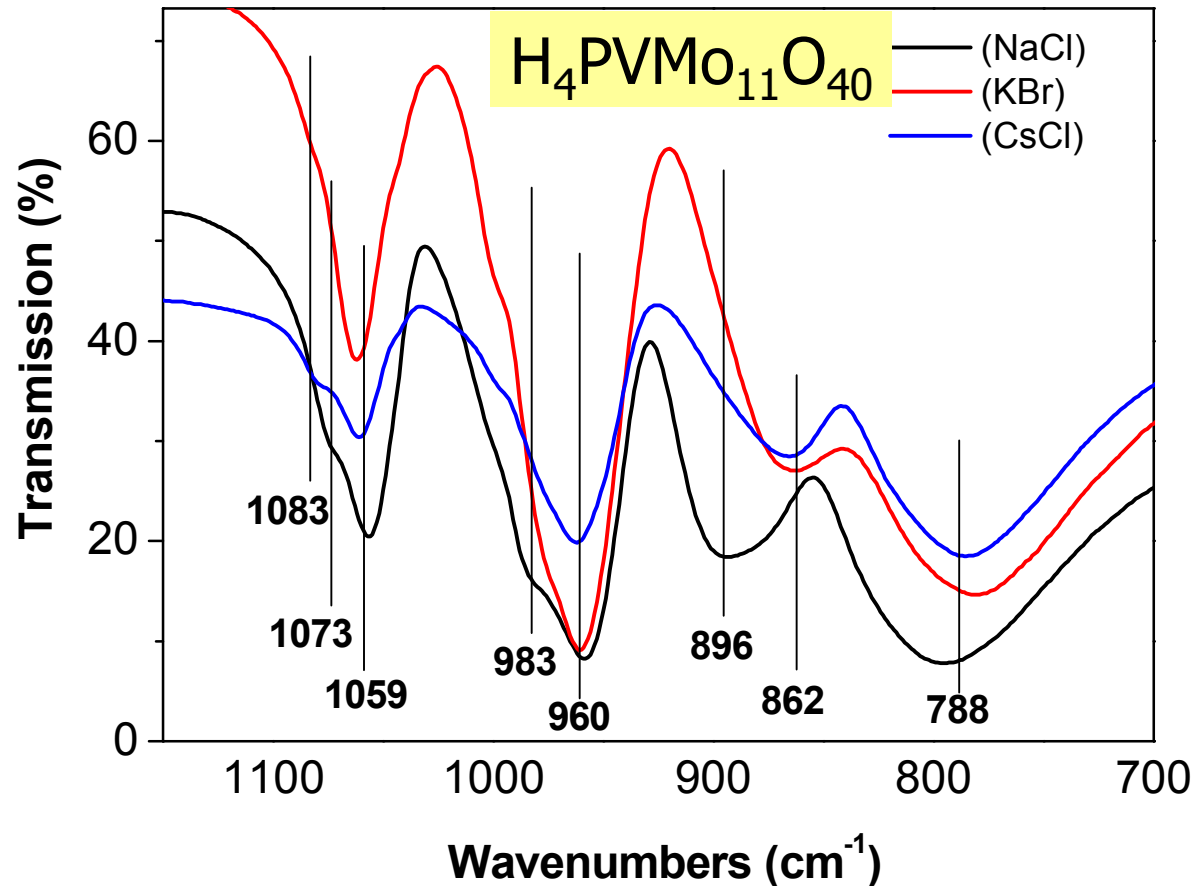

❖ reaction with diluent possible

Limitations of Transmission Spectroscopy

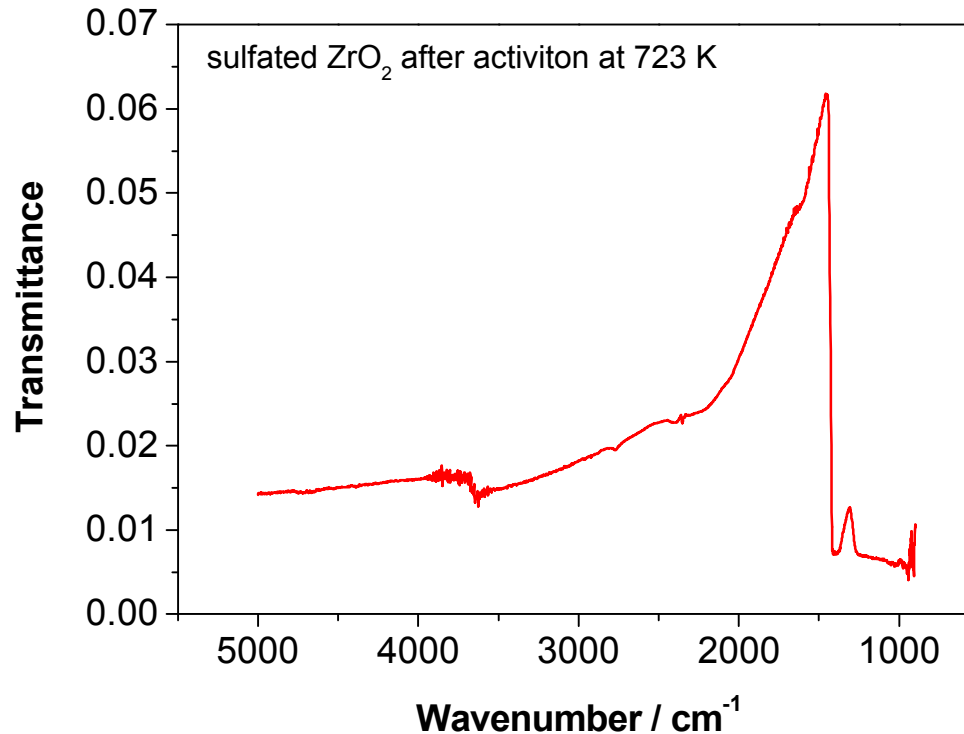

- ❖ transmission can become very low! even in IR regime!
- ❖ catalysts are fine powders (high surface area)
- ❖ embedding (KBr) not desirable for in situ studies (heating, reaction)

Can We Use the Reflected Light?

- ❖ instead of measuring the transmitted light, we could measure the reflected light
- ❖ can we extract the absorption properties of our sample from the reflected light?

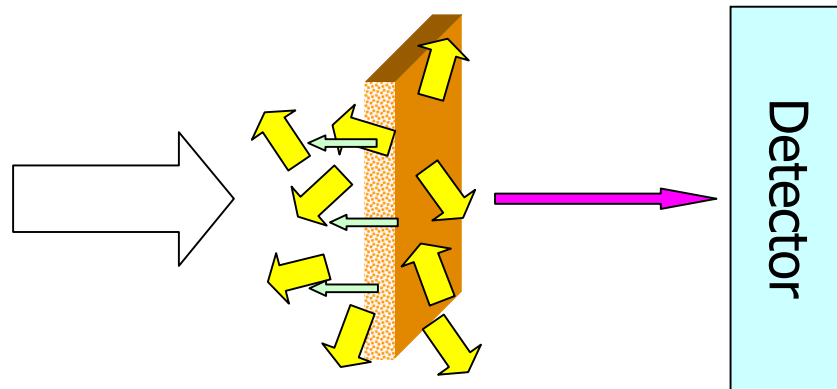

Specular & Diffuse Reflection

Reflection of radiant
energy at boundary
surfaces

mirror-type
(polished) surfaces

mat (dull, scattering)
surfaces

Specular

Diffuse

mirror-type reflection
mirror reflection
surface reflection
specular reflection
reguläre Reflexion
gerichtete Reflexion

multiple reflections at
surfaces of small
particles

reflecting power called
"reflectivity"

reflecting power called
"reflectance"

Specular Reflection (Non-Absorbing Media)

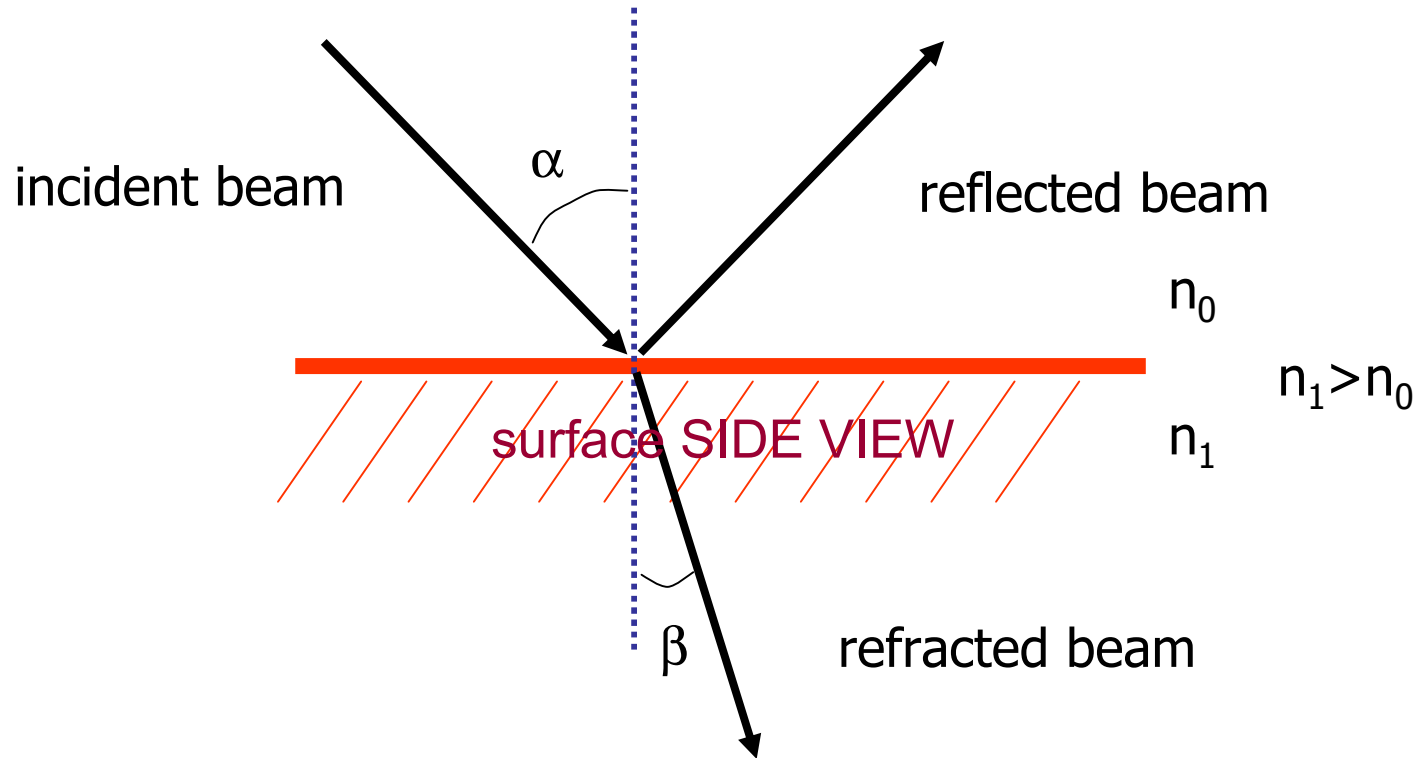

- ❖ fraction of reflected light increases with α
- ❖ β depends on α and ratio of the refractive indices (Snell law)

Specular Reflection: Angular Distribution

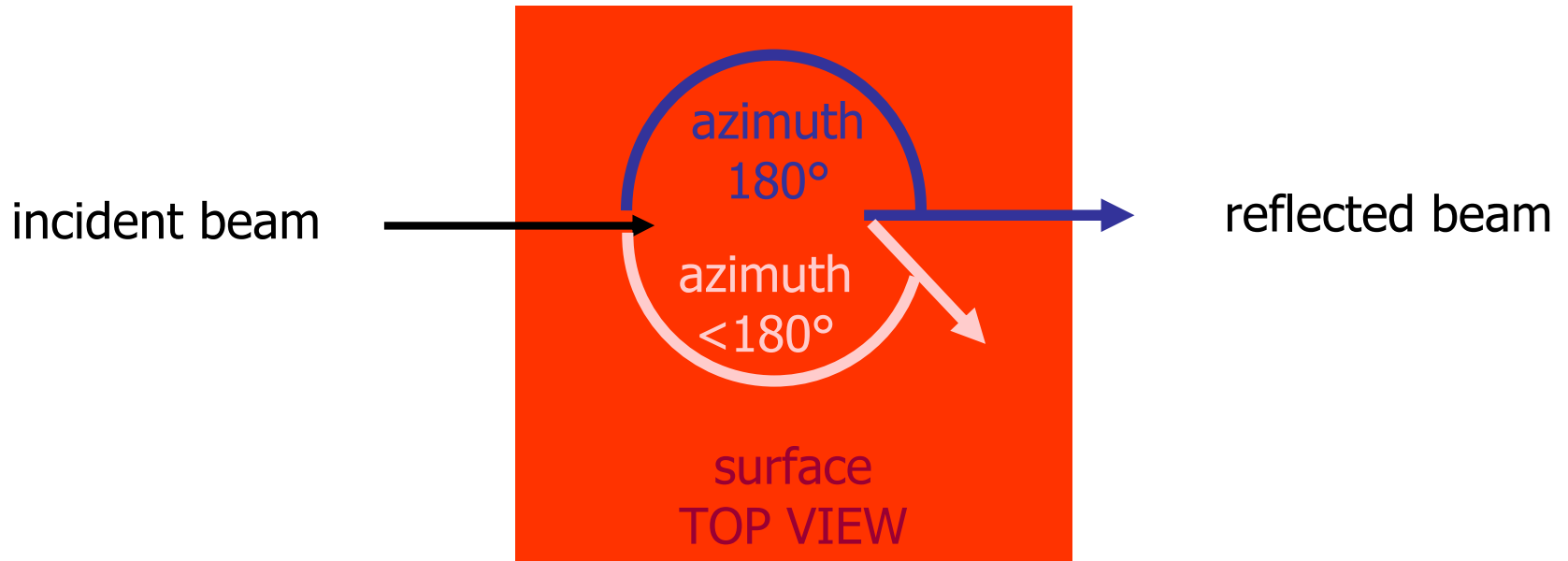

- ❖ the intensity of the specularly reflected light is largest at an azimuth of 180°

Diffuse Reflection & Macroscopic Surface Properties

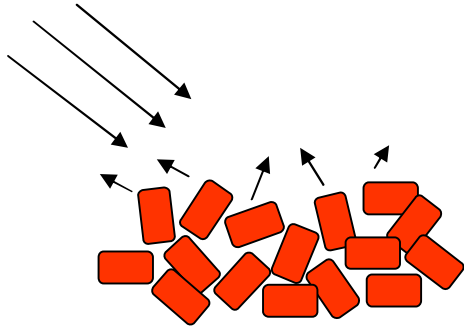

- ❖ randomly oriented crystals in a powder: light diffusely reflected

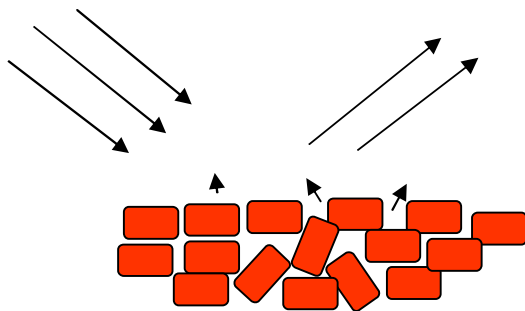

- ❖ flattening of the surface or pressing of a pellet can cause orientation of the crystals, which are “elementary mirrors”
- ❖ causes “glossy peaks” if angle of observation corresponds to angle of incidence
- ❖ solution: roughen surface with (sand)paper or press between rough paper, or use different observation angle!

Light Reflection from Powders: Why is the Distribution Isotropic?

particle diameter $d > \lambda$

- ❖ light partially reflected on elementary mirrors (crystal facets) inclined statistically at all possible angles to the macroscopic surface
- ❖ light penetrates into sample, undergoes numerous reflections, refractions and diffraction and emerges finally diffusely at the surface

particle diameter $d \leq \lambda$

- ❖ scattering occurs
- ❖ Mie's theory for single scattering says distribution is not isotropic
- ❖ multiple scattering should produce isotropic distribution

The Rayleigh Scattering Theory

- ❖ according to Rayleigh (Gans, Born)
- ❖ electromagnetic wave induces vibrating dipole in molecule (i.e. $d \ll \lambda$), electrons assumed to be in phase, molecular antenna
- ❖ dipole emits electromagnetic waves in all directions, i.e. the primary wave is being scattered

$$I_{scat} \propto \frac{1}{\lambda^4}$$



The Mie Scattering Theory

- ❖ rigorous theory for single scattering of a planar wave at **spherical particles**, both dielectric and absorbing, of any size
- ❖ in the limit of **infinite diameter**, the Mie theory approaches a scattering distribution as can be obtained from the law of geometrical optics by dealing separately with reflection, refraction, and diffraction

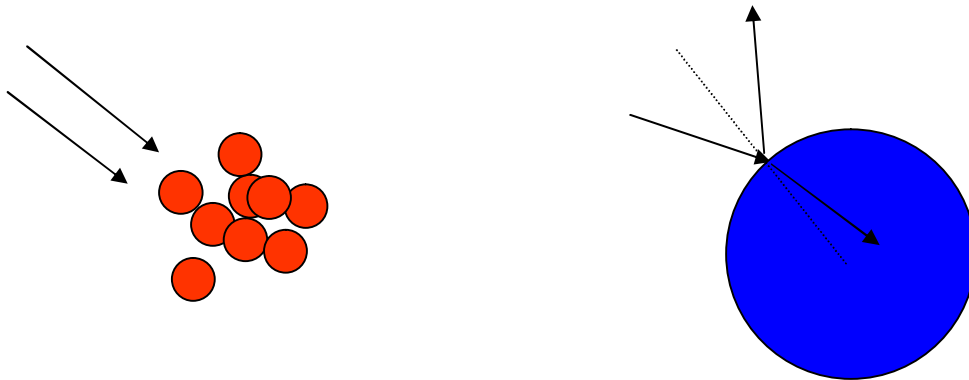

- ❖ according to the Mie formula, there is no principle distinction between reflection, refraction, and diffraction on one hand and scattering on the other hand

Typical Catalyst Particles

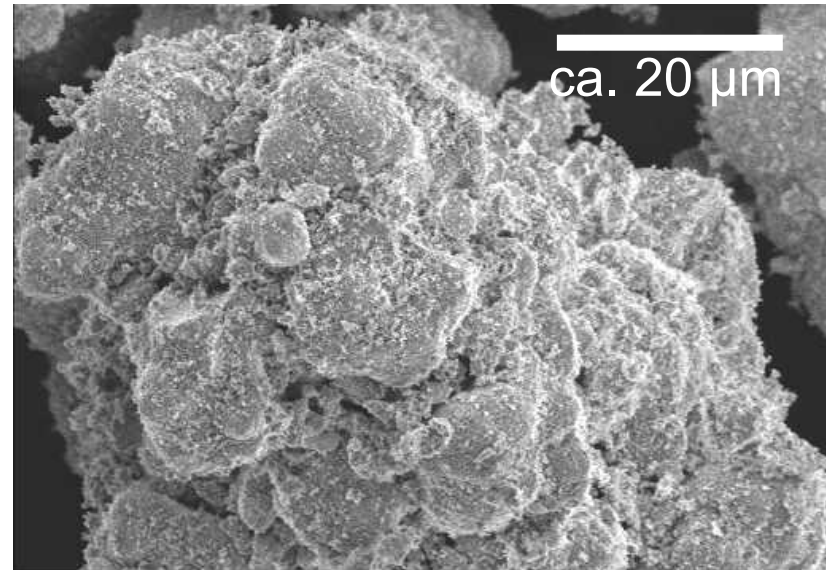
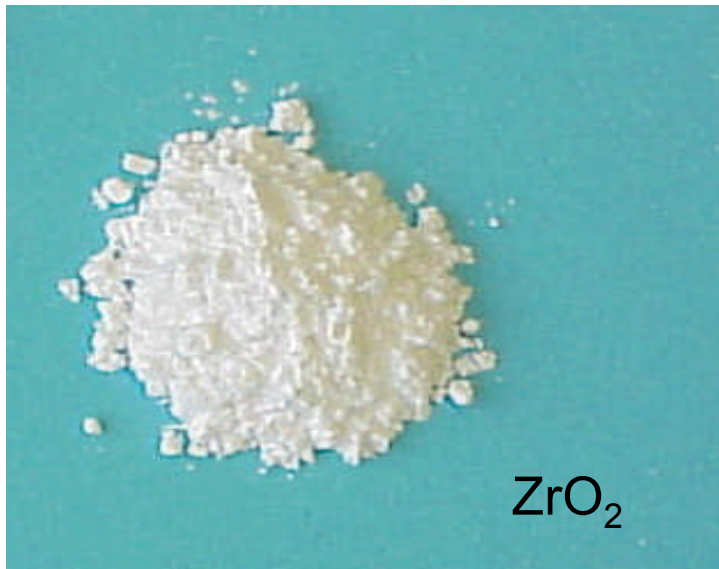

scanning electron microscopy image

- ❖ need theory that treats light transfer in an absorbing and scattering medium
- ❖ want to extract absorption properties!

The Schuster-Kubelka-Munk Theory

Assumptions

- ❖ incident light diffuse
- ❖ isotropic distribution (Lambert cosine law valid) , i.e. no regular reflection
- ❖ particles randomly distributed
- ❖ particles much smaller than thickness of layer

2 constants are needed to describe the reflectance:
absorption coefficient k
scattering coefficient s

$$F(R_\infty) = \frac{(1 - R_\infty)^2}{2R_\infty} = \frac{k}{s}$$

Kubelka-Munk function
remission function

Kubelka-Munk Function

- ❖ mostly we measure R'_∞ , i.e. not the absolute reflectance R_∞ but the reflectance relative to a standard
- ❖ depends on wavelength $F(R'_\infty)_\lambda$
- ❖ corresponds to extinction in transmission spectroscopy
- ❖ in case of a dilute species is proportional to the concentration of the species (similar to the Lambert-Beer law):

$$F(R'_\infty) \propto \frac{e c}{s}$$

Deviations from & Limitations of the Kubelka-Munk Theory

incident radiation

- ❖ should be diffuse and not directed, however, it is assumed that after a few scattering events the distribution is isotropic
- ❖ directed incident radiation can be a problem on very rough surfaces: shadowing effects

any regular reflection

- ❖ will cause deviation

low reflectance values

- ❖ applicability of Kubelka-Munk theory questionable
- ❖ smallest error between $0.2 < R_{\infty} < 0.6$

Transmission vs. Reflection Spectroscopy

- ❖ for quantification and to be able to calculate difference spectra: calculate absorbance / Kubelka-Munk function

$$A = -\ln T$$

$$F(R) = \frac{(1-R)^2}{2R}$$

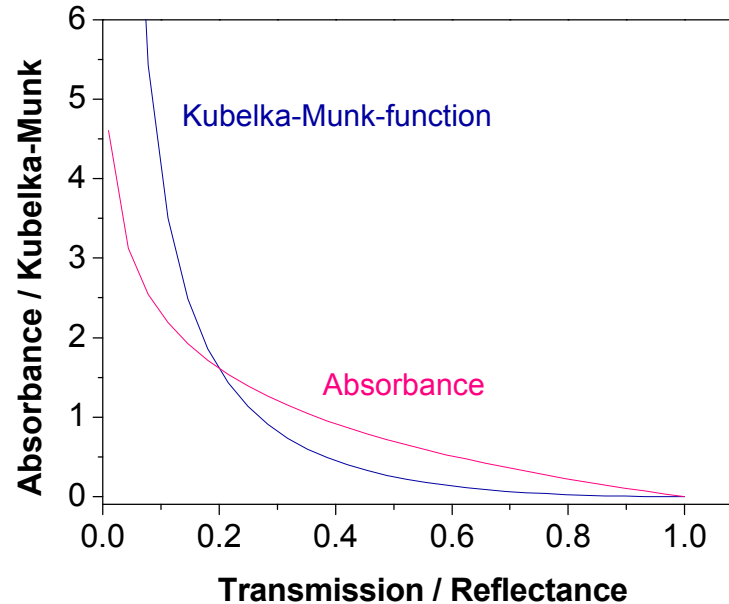

Transmission vs. Reflection Spectroscopy

$$A = -\ln T$$

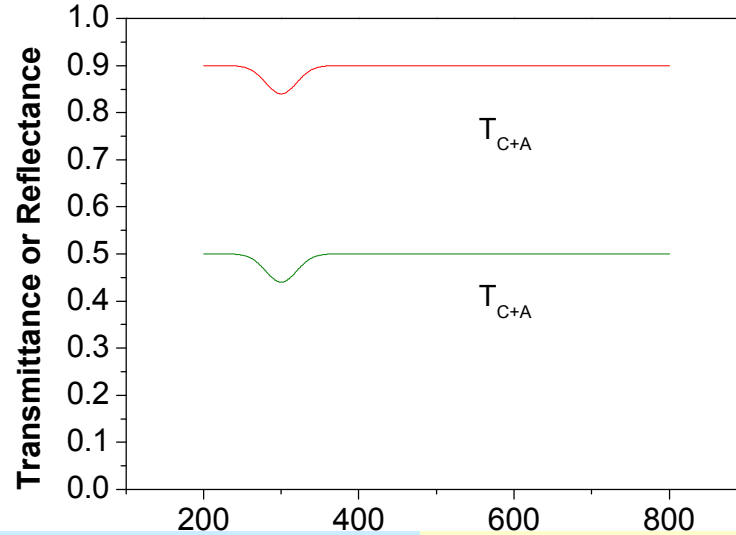

$$F(R) = \frac{(1 - R)^2}{2R}$$

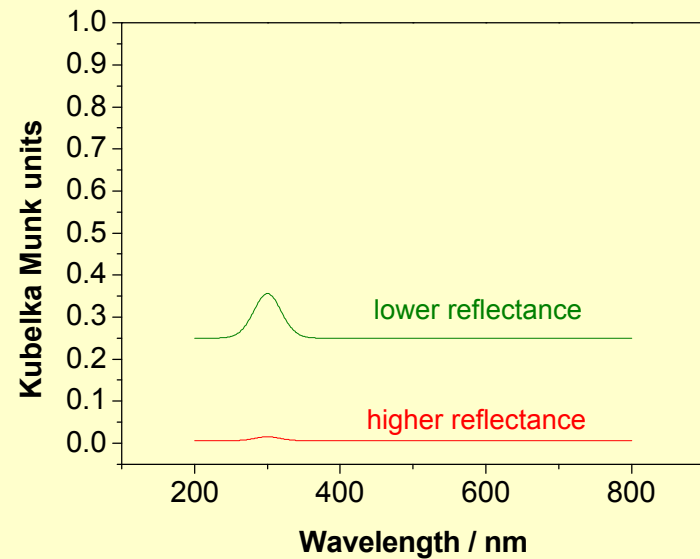
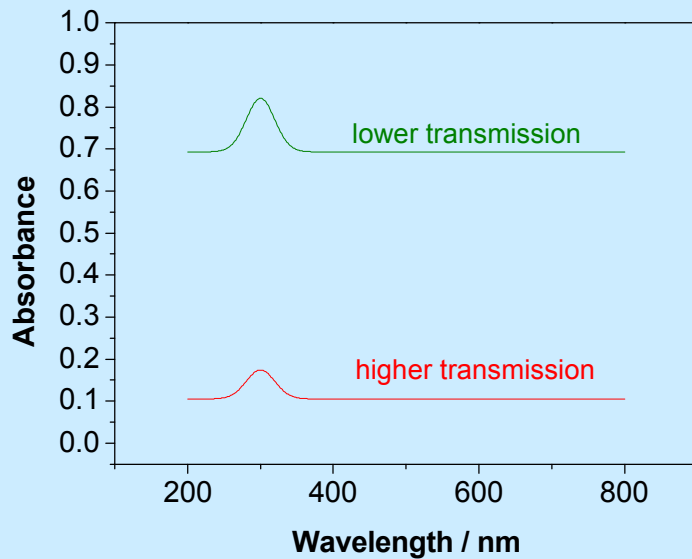

Spectroscopy in Transmission

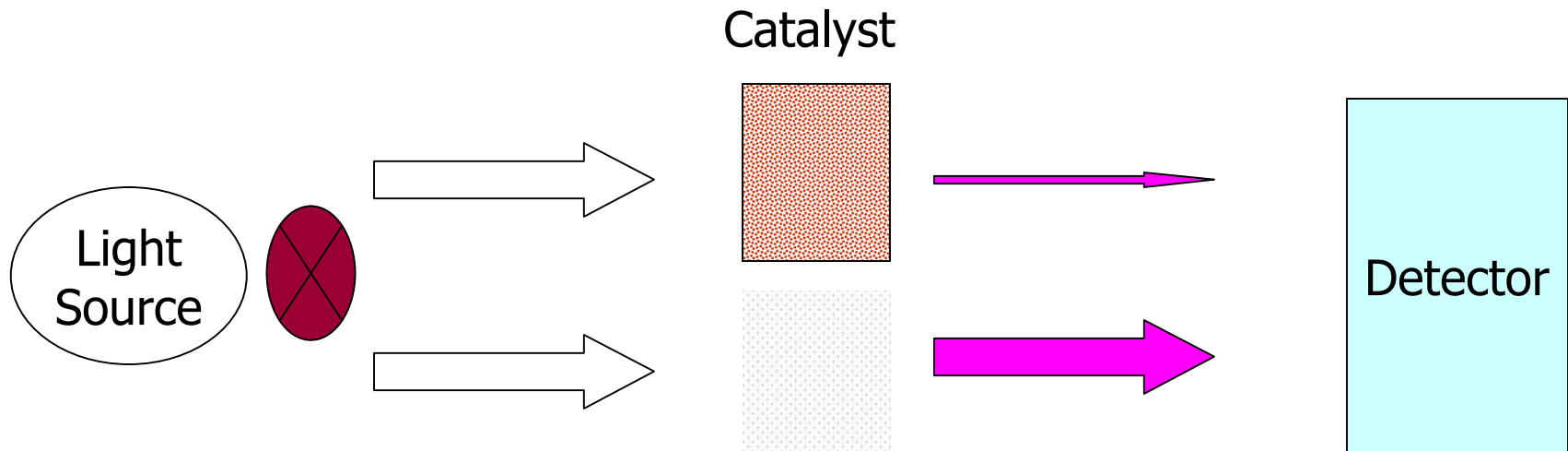

reference „nothing“
= void, empty cell, cuvette
with solvent

spectrum:
transmission of
catalyst vs.
transmission of
reference

- ❖ in IR transmission is widely applied for solids
- ❖ in UV-vis transmission is rarely used for solids

Reflectance Spectroscopy

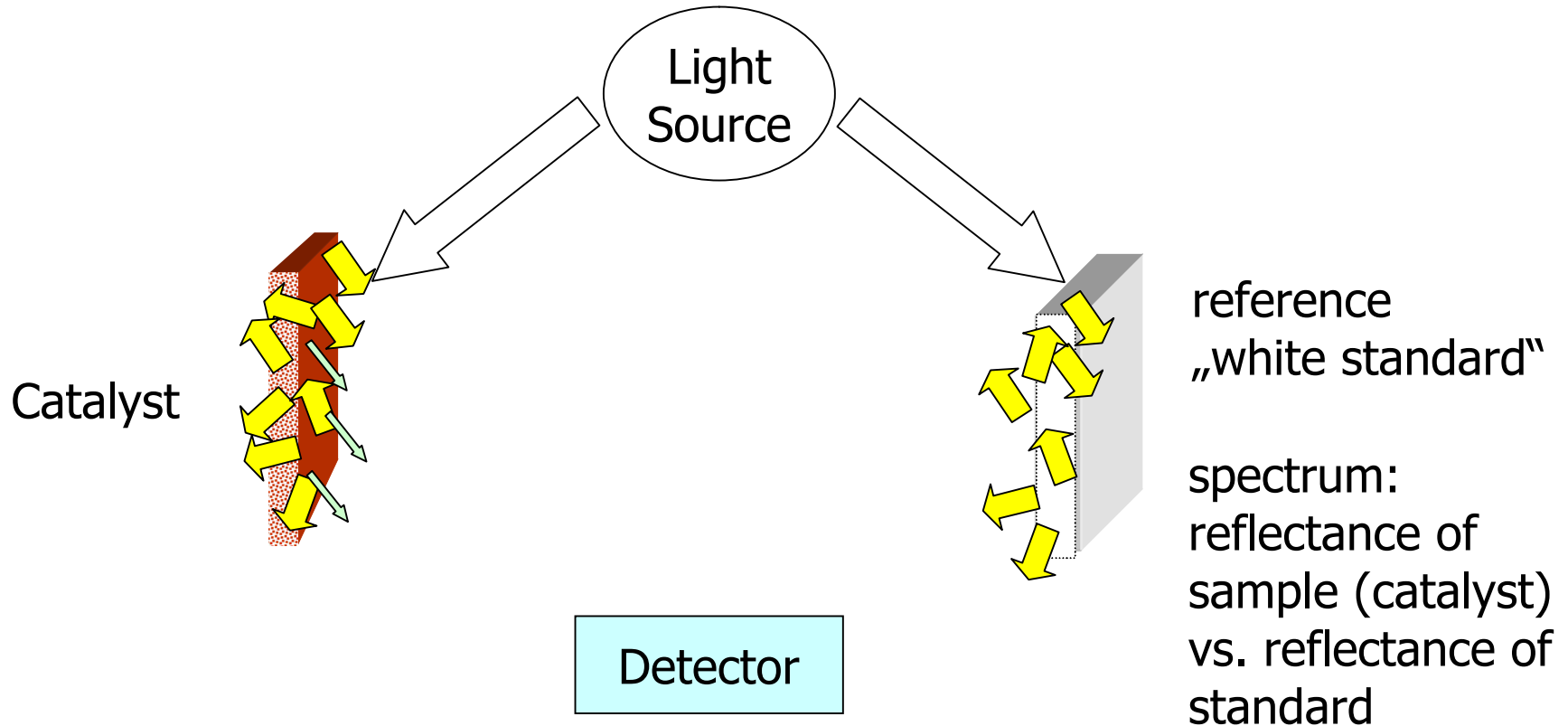

- ❖ need element that collects diffusely reflected light
- ❖ need to avoid specularly reflected light
- ❖ need reference standard (white standard)

“White” Standards

- ❖ KBr: IR (43500-400 cm^{-1})
- ❖ BaSO_4 : UV-vis
- ❖ MgO: UV-vis
- ❖ Spectralon: UV-vis-NIR

White Standard MgO

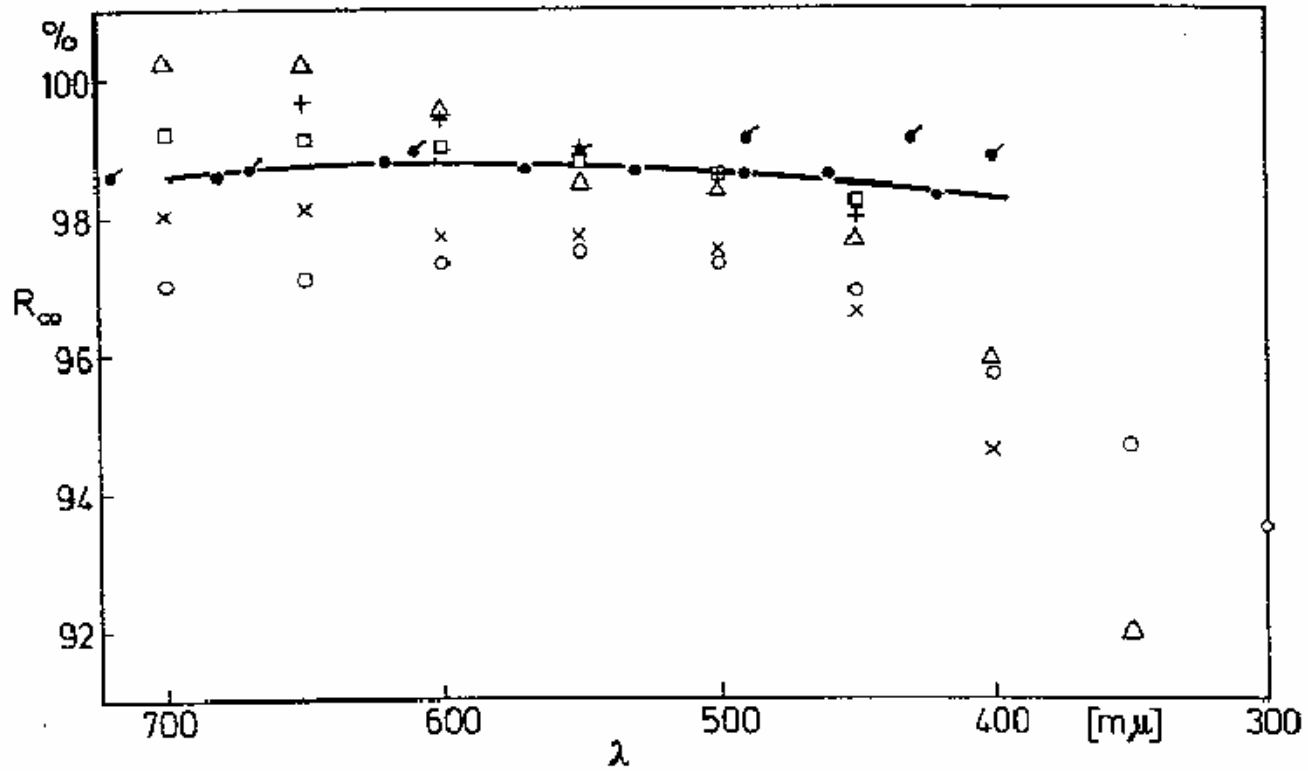

❖ ages rapidly

White Standard BaSO₄

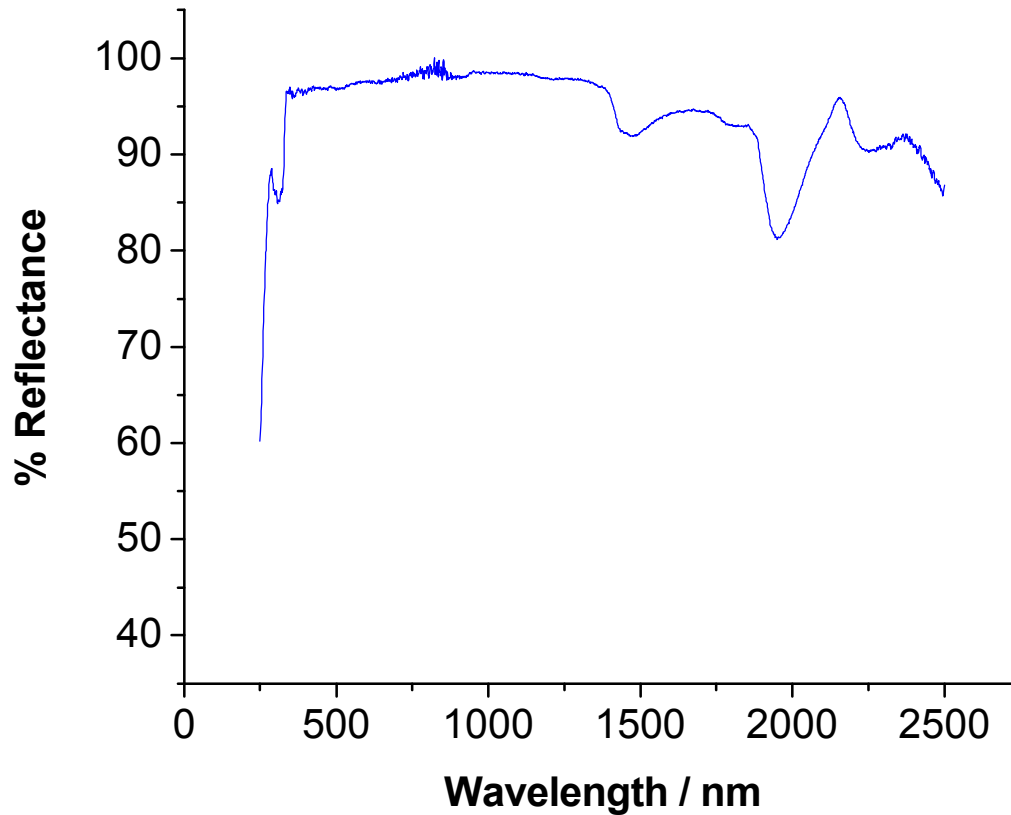

- ❖ reflects well in range 335 – 1320 nm
- ❖ humid!

White Standard Spectralon®



TYPICAL 8°/HEMISPHERICAL REFLECTANCE- OPTICAL GRADE SPECTRALON

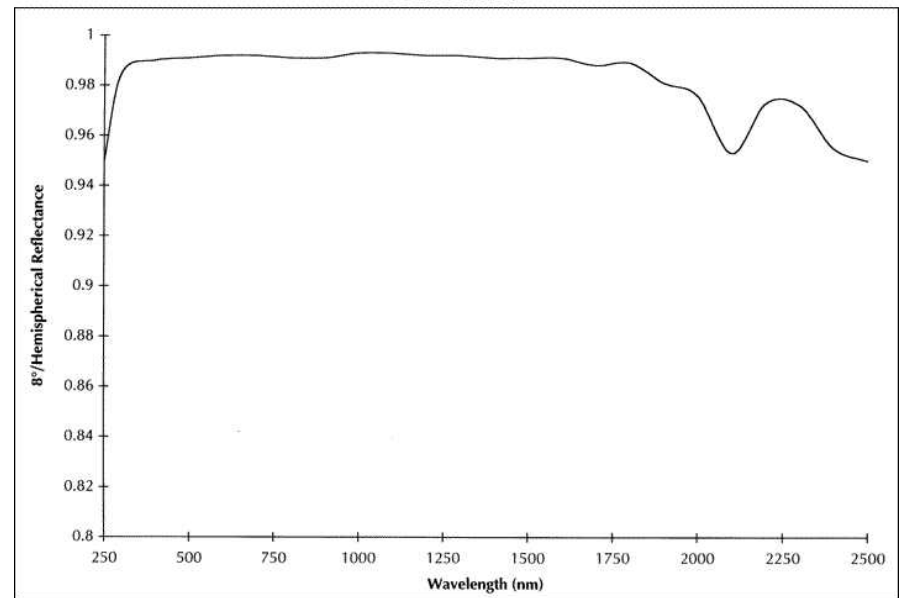

Spectralon® thermoplastic resin, excellent reflectance in UV-vis region

„Gray“ Standards

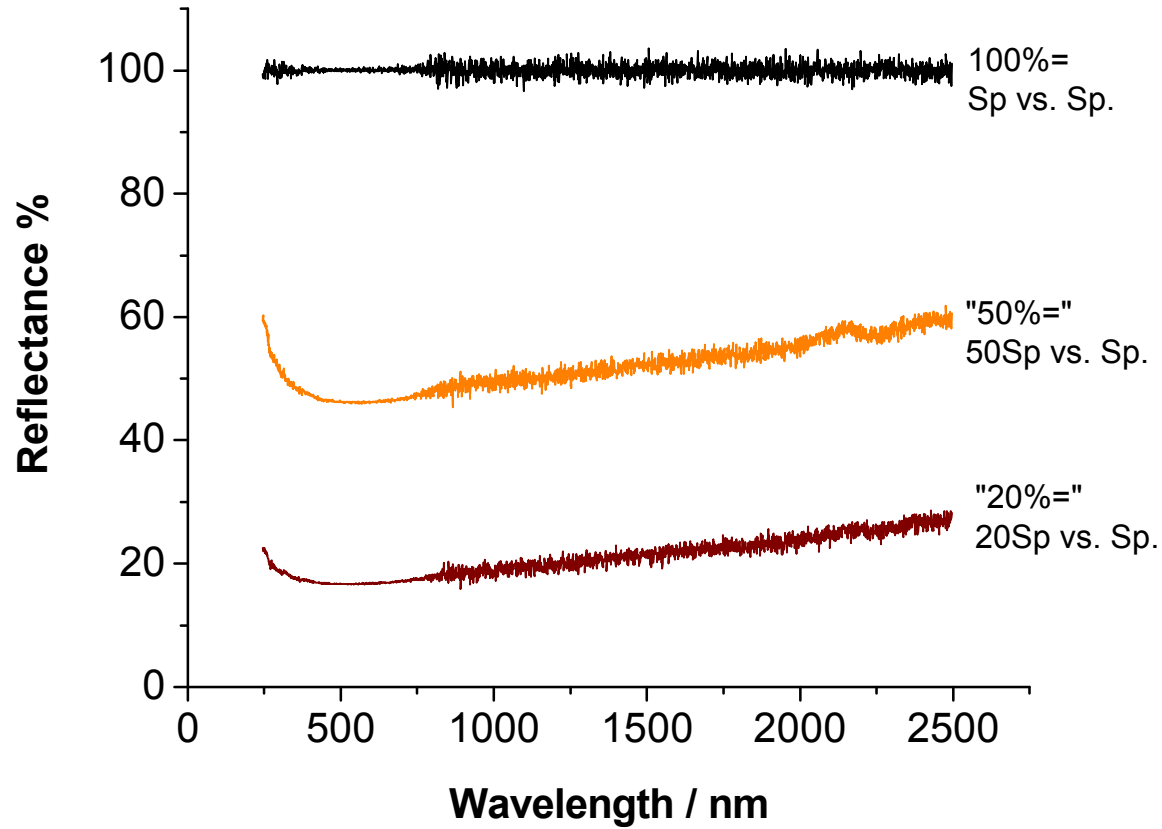

The Collection Elements

- ❖ integrating spheres (UV-vis-NIR)
- ❖ fiber optics (UV-vis-NIR)
- ❖ mirror optics (IR and UV-vis-NIR)

Integrating Spheres

❖ also called: photometer spheres, Ulbricht spheres

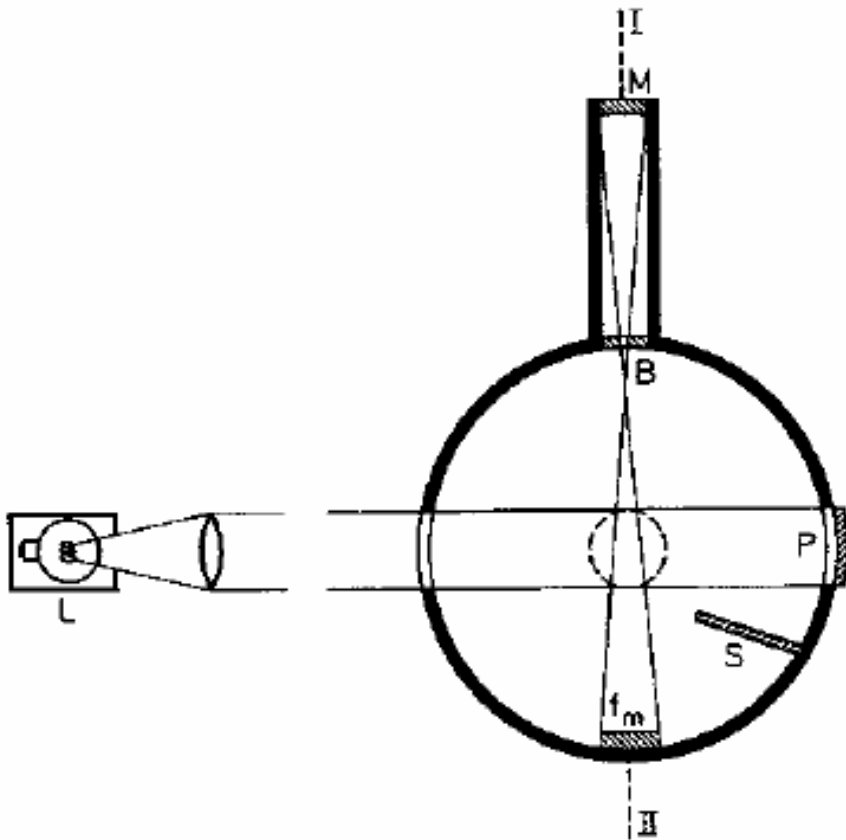

$$I_P = I_0 r_W r_P \frac{f_m f_M}{F^2} r_K \frac{1}{1 - r_K}$$

F total internal surface of sphere
 f_m, f_M relative fractions of measuring surface and opening aperture
 ρ_W absolute reflectance of wall
 ρ_P absolute reflectance of sample
 ρ_K absolute reflectance of sphere
 S screen blocks regular reflection

$$r_K = \left(1 - \frac{f_M + f_E + f_P}{F} \right) r_W + \frac{f_P}{F} r_P$$

Integrating Spheres: Coatings

- ❖ BaSO₄: UV-vis
- ❖ MgO: UV-vis
- ❖ Spectralon: UV-vis-NIR
- ❖ Au: 800 nm to MIR

In Situ Cell & Integrating Sphere

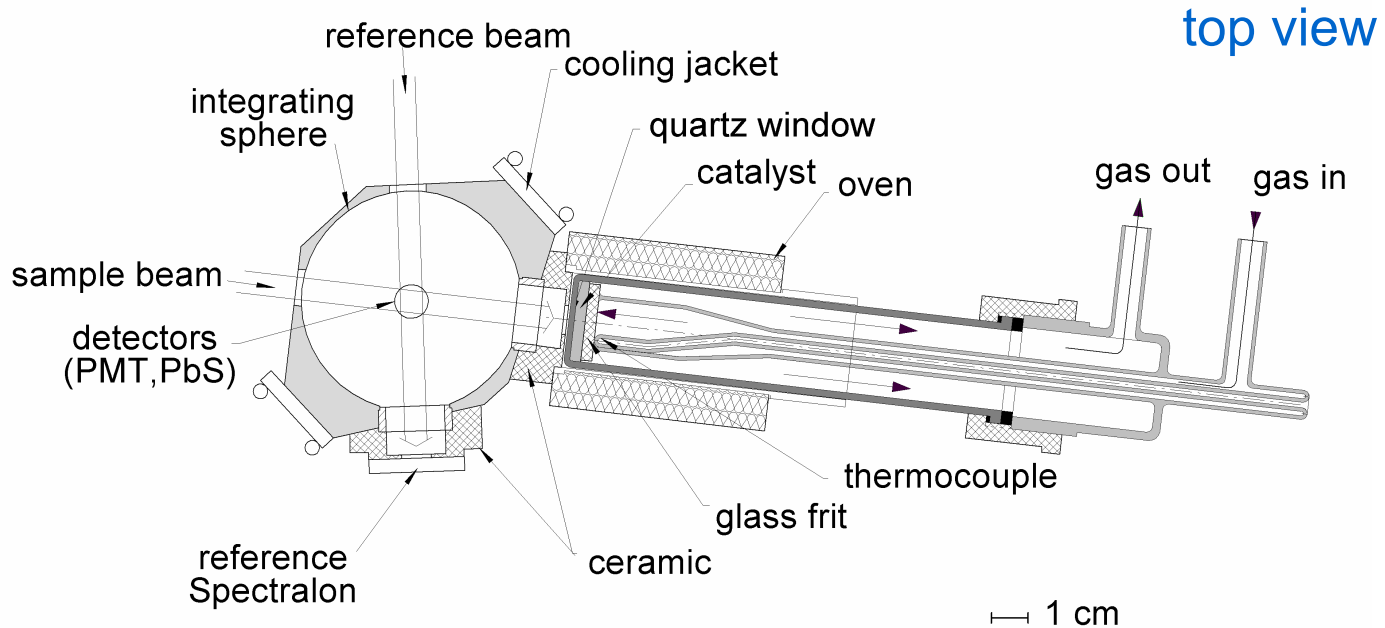

- ❖ beam path equivalent for sample and reference beam
- ❖ spectrometer background correction can be used
- ❖ window (Suprasil or Infrasil): absorbs and reflects light

Catalyst Deactivation: in situ UV-vis Spectroscopy

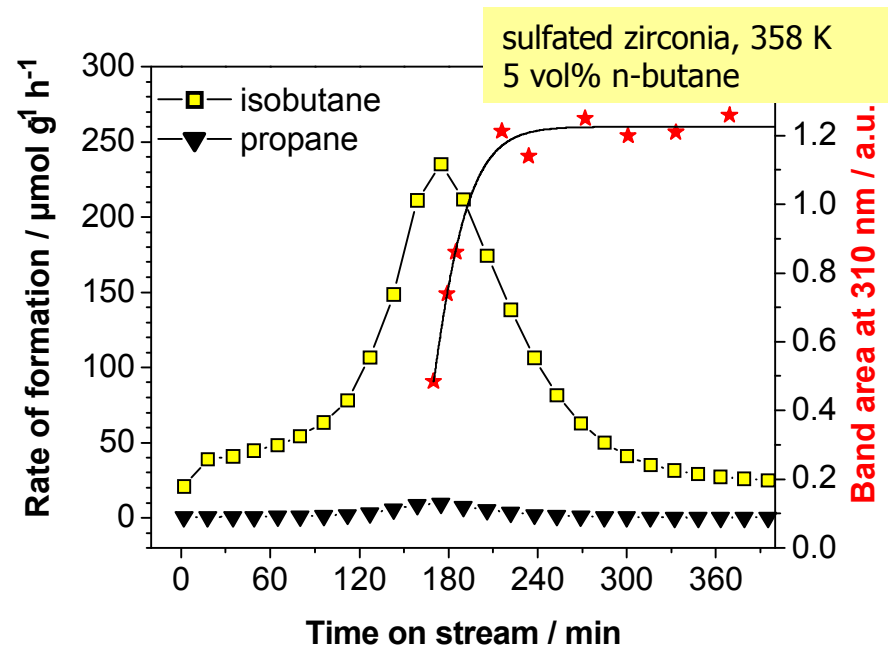
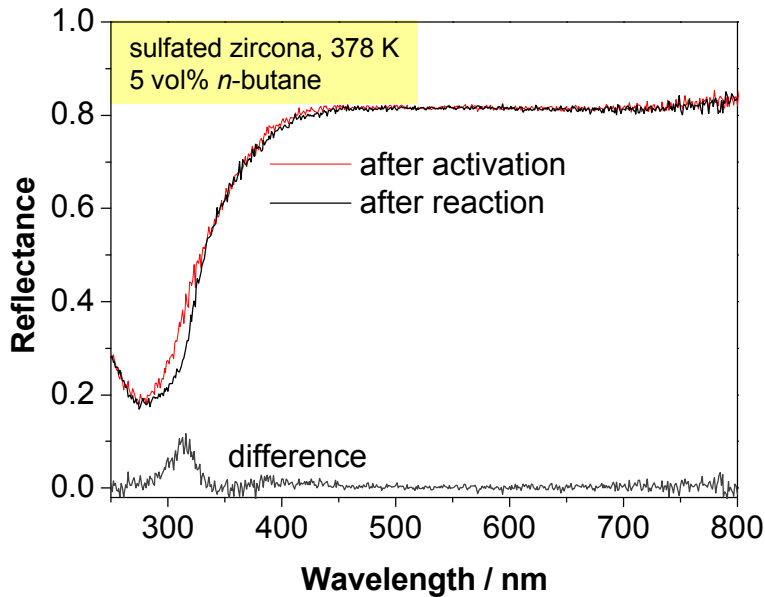

- ❖ formation of additional bands during *n*-butane isomerization
- ❖ band at 310 nm, allylic cations? Analyzed using apparent absorption $A=1-R$
- ❖ spectroscopic and catalytic data can be correlated

Mirror Optics

- ❖ can be placed into the normal sample chamber (in line with beam), no rearrangement necessary
- ❖ good in IR
- ❖ some disadvantages in UV-vis

How to Avoid Specular Reflection (1)

SIDE VIEW

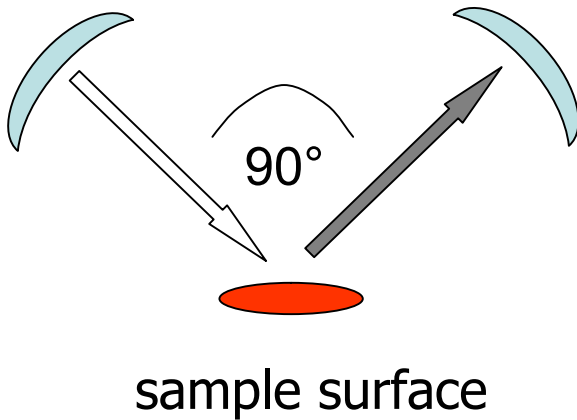

TOP VIEW

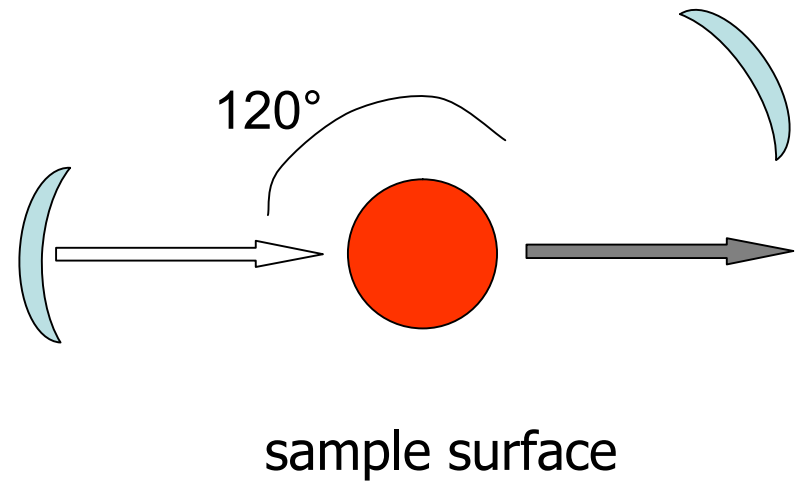

- ❖ specular reflection is strongest in forward direction
- ❖ collect light in off-axis configuration

The Harrick Praying Mantis

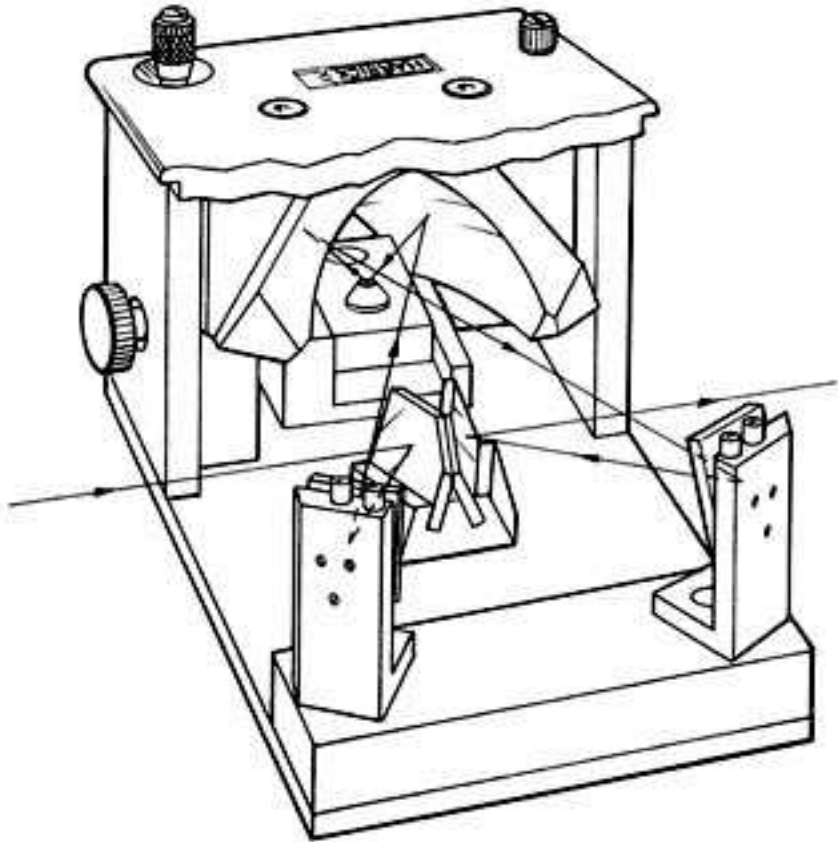

- ❖ first ellipsoidal mirror focuses beam on sample
- ❖ second ellipsoidal mirror collects reflected light
- ❖ 20% of the diffusely reflected light is collected

alignment can be tested

- ❖ align with flat mirror (= only specular reflection): minimize throughput
- ❖ align with tilted mirror: maximize throughput

Mirror Optics: Throughput in MIR Range

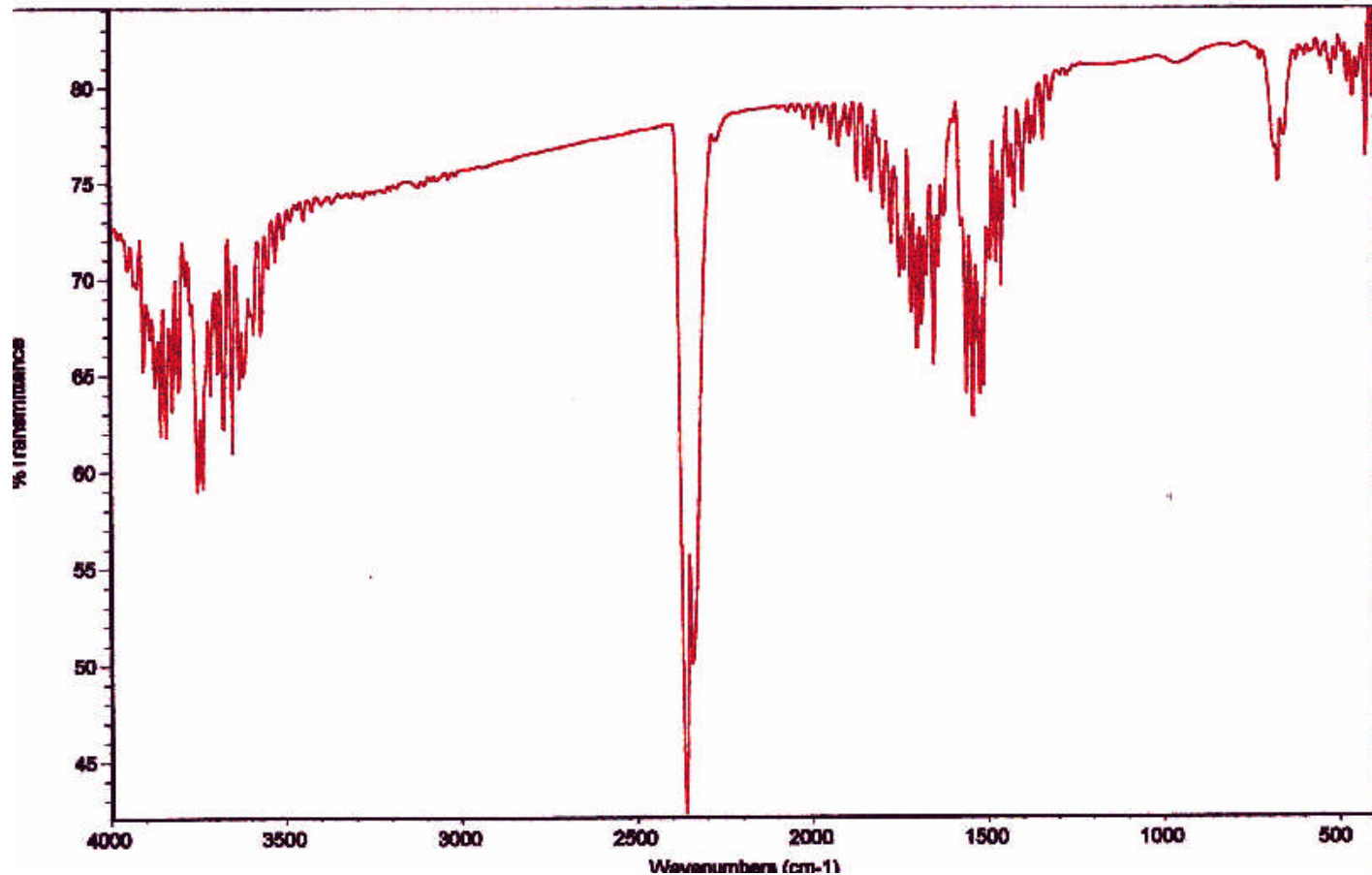

- ❖ throughput measured with tilted mirror
- ❖ mirror optics work well in the IR range....

Mirror Optics: Throughput in UV-vis-NIR Range

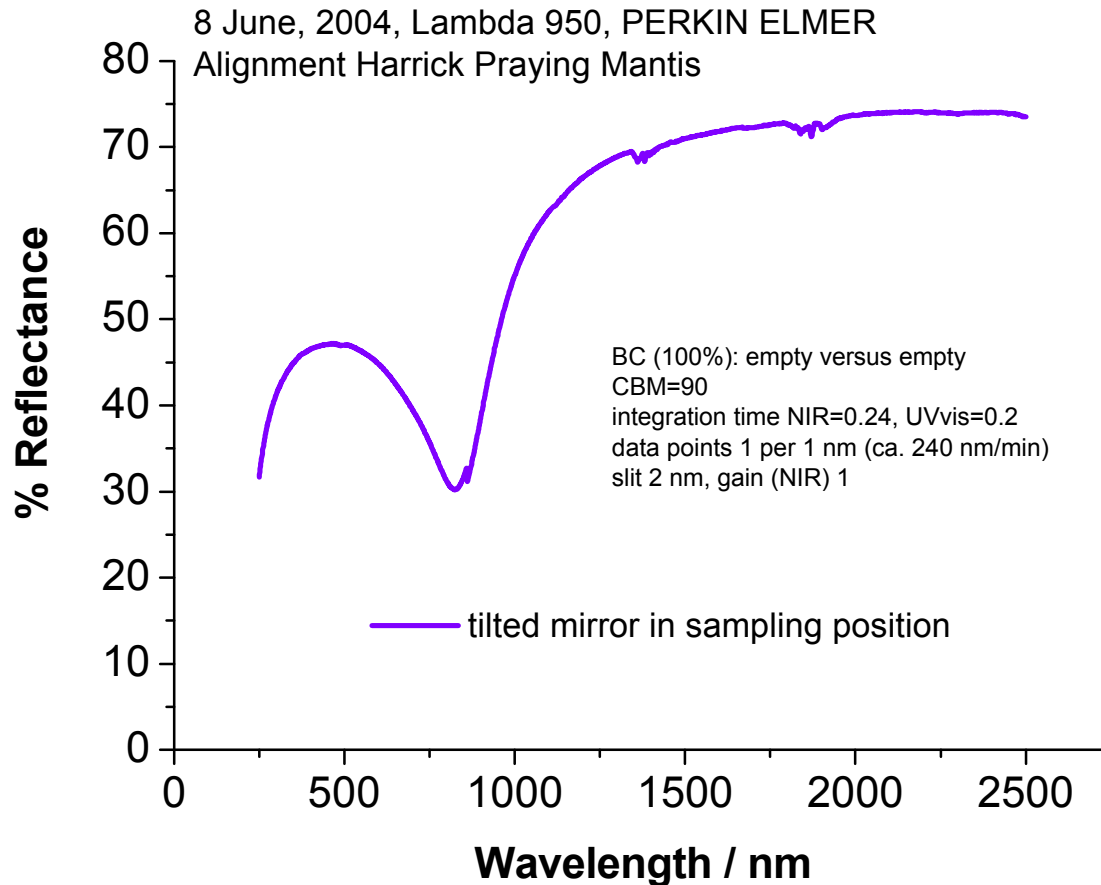

- ❖ aluminum coating of mirrors absorbs light! Here: 7 mirrors
- ❖ spectra will be more noisy in region of low throughput

The Harrick Praying Mantis Reaction Chamber



- ❖ quartz windows (high pressure version available)
- ❖ up to 873 K (lot T version with Dewar available)
- ❖ powder bed rest on stainless steel grid: flow through bed
- ❖ low dead volume

Mirror Optics: UV-vis-NIR Range with Quartz Dome and Spectralon[®]

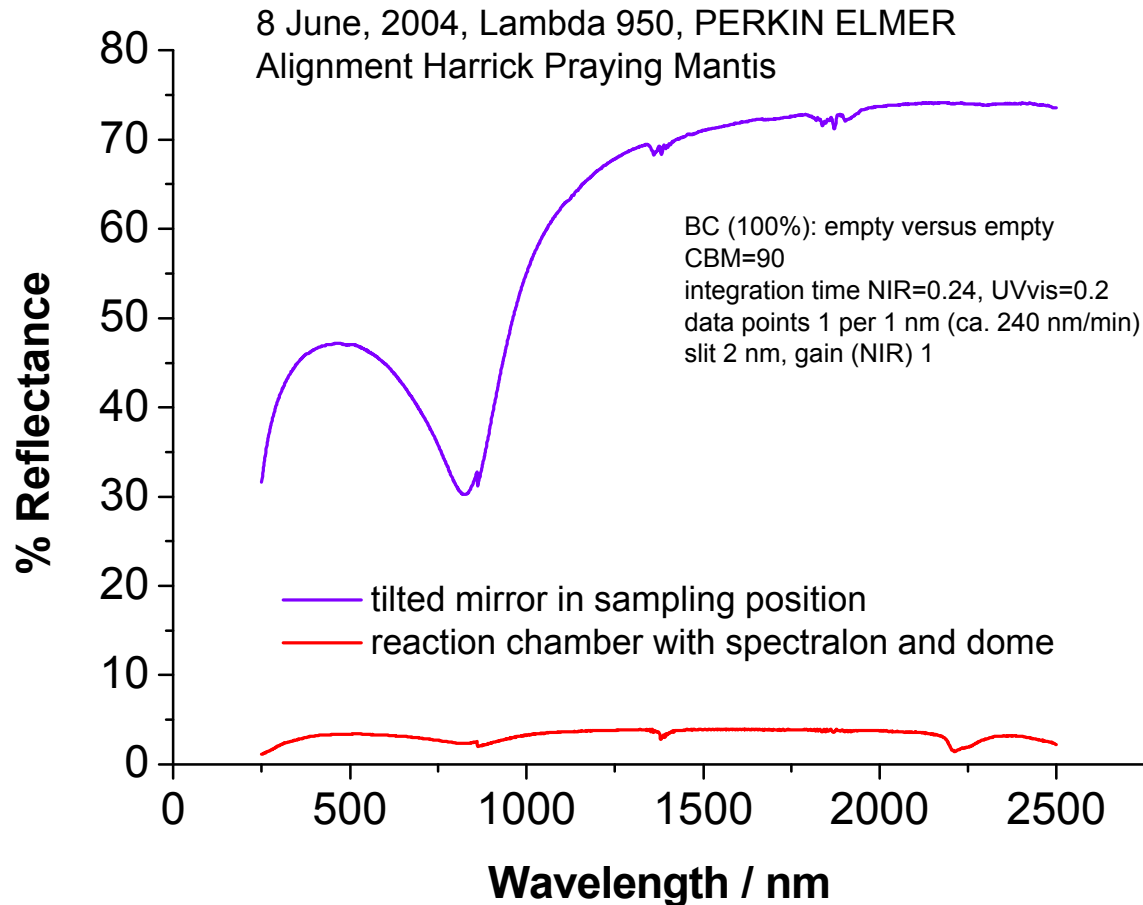

❖ very low light yield

❖ need spectrometer that works well under these conditions

Mirror Optics: UV-vis-NIR Range with Quartz Dome and Spectralon®

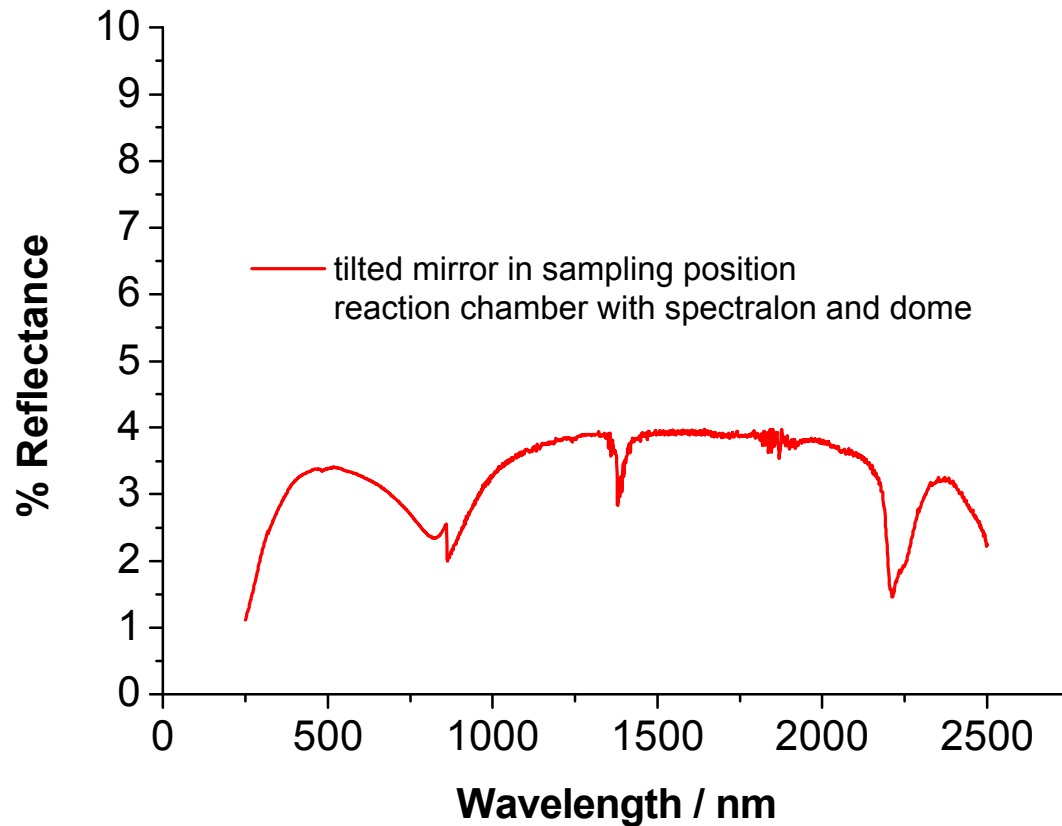

- ❖ an attenuator may be necessary in the reference beam
- ❖ artifacts from change of optical components (gratings, filters, detectors, lamps) may become visible

Example: Catalyst Activation

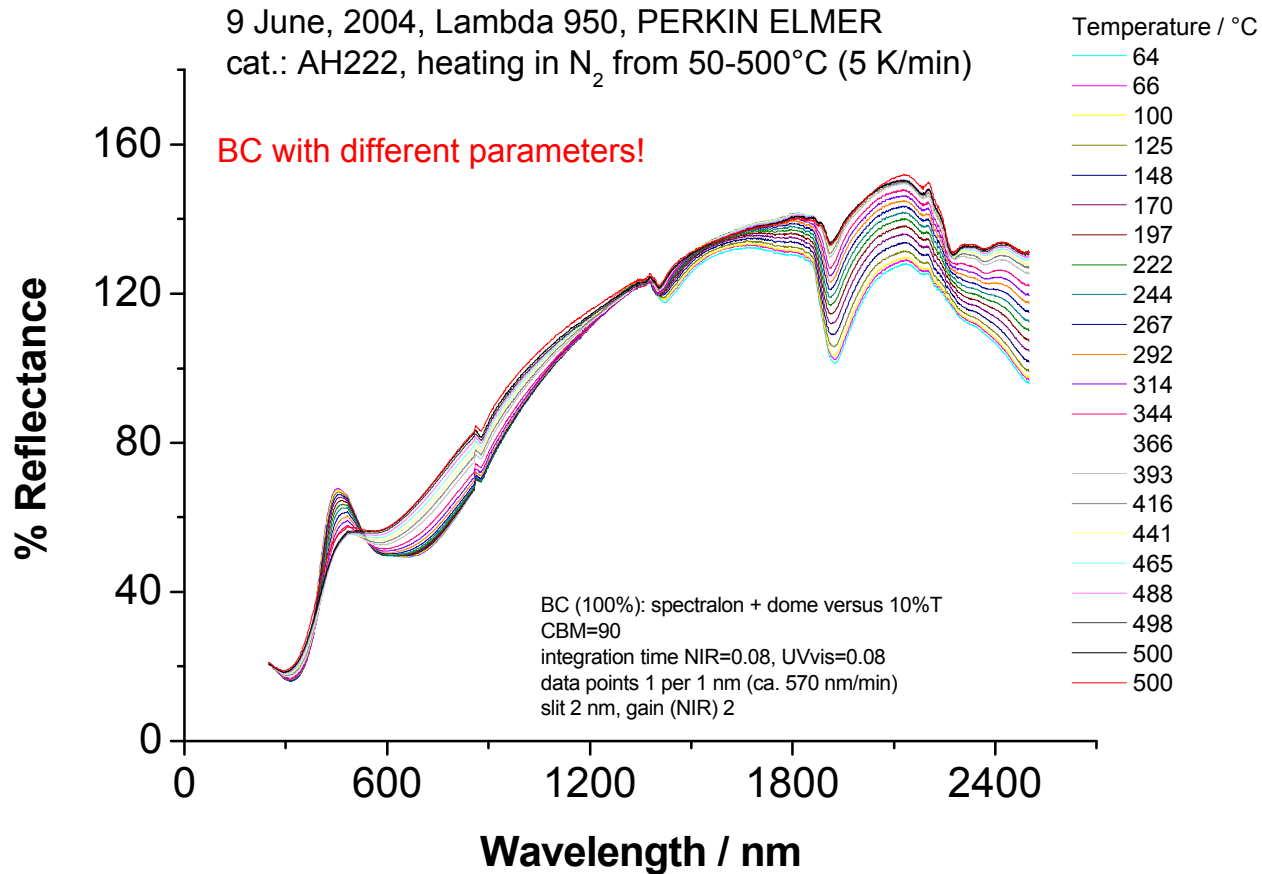

❖ UV-vis NIR gives information on valences and water content

Diffuse Reflectance IR (DRIFTS): Graseby Specac Selector Optics and Environmental Chamber

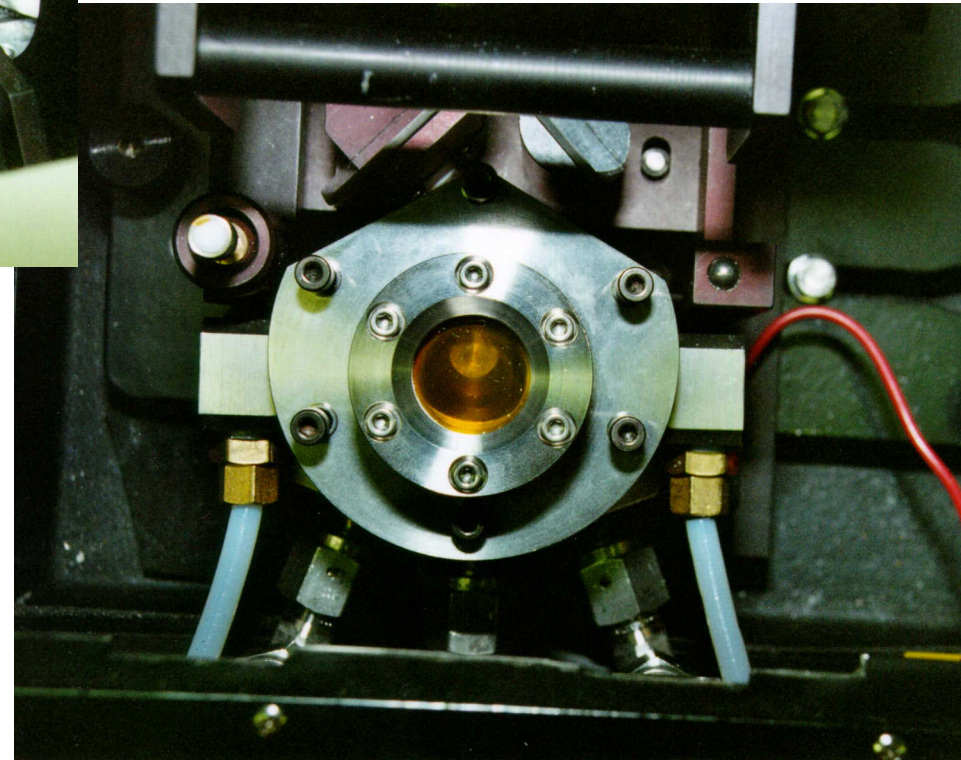
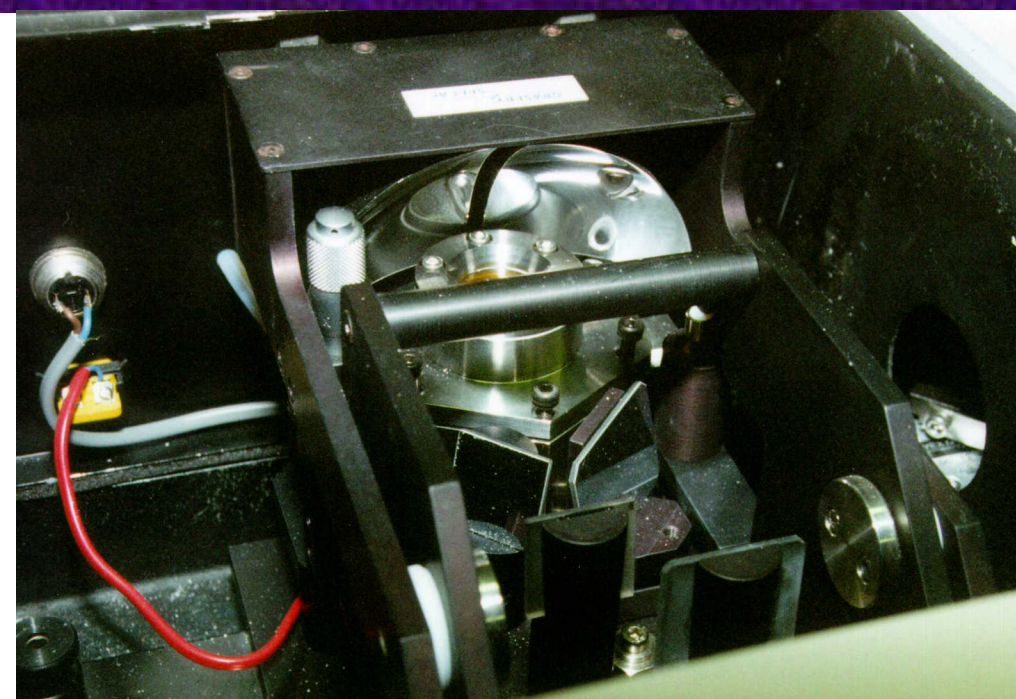

- ❖ ZnSe window (chemically resistant)
- ❖ up to 773 K
- ❖ no flow through be (rest in cup)
- ❖ large dead volume (est. 100 ml)

Comparison Transmission - Diffuse Reflectance

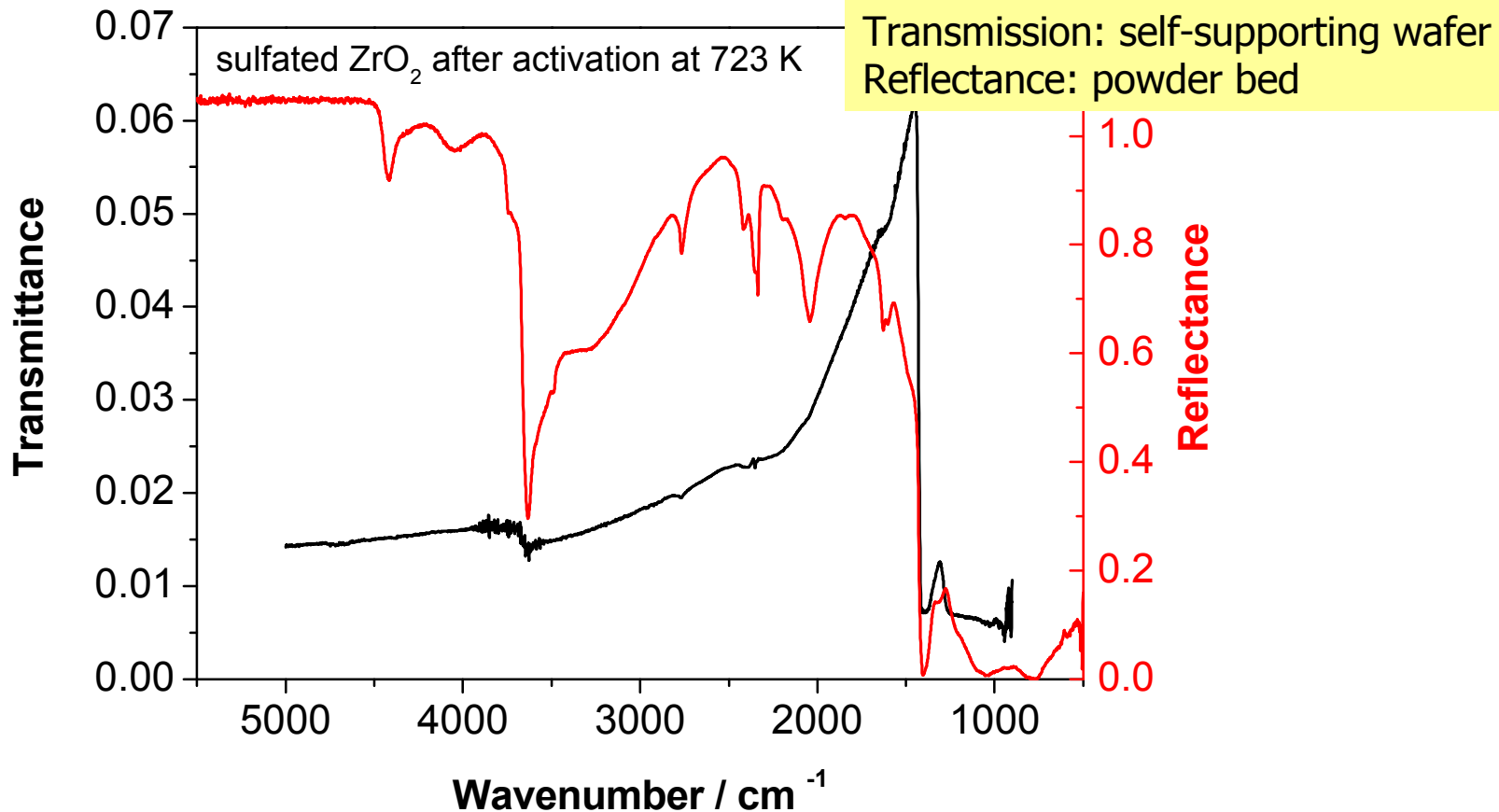

- ❖ spectra can have completely different appearance
- ❖ transmission decreases, reflectance increases with increasing wavenumber

Comparison Transmission - Diffuse Reflectance

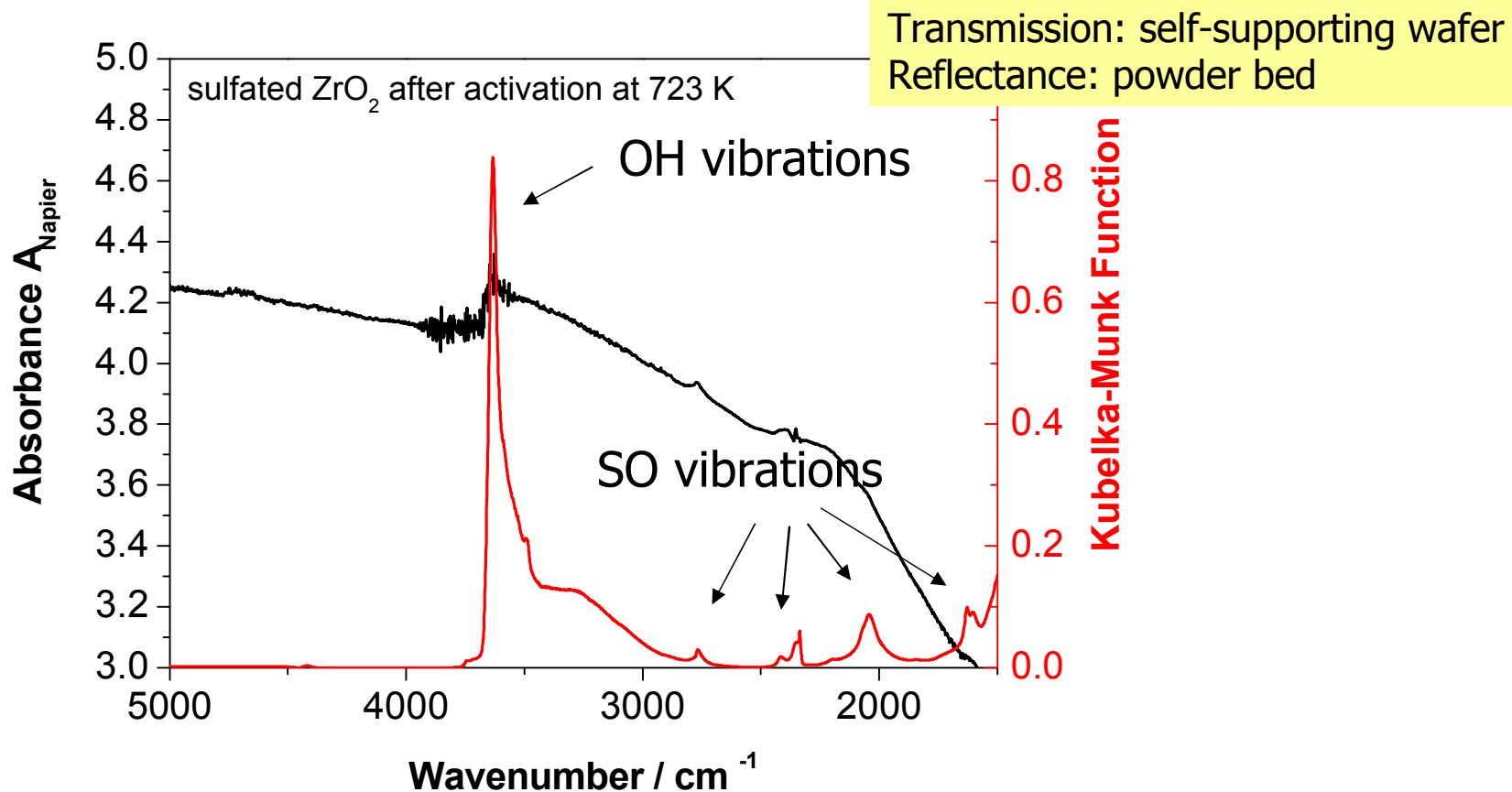

- ❖ vibrations of surface species may be more evident in DR spectra

n-Butane Isomerization over MnSZ: In Situ DRIFTS

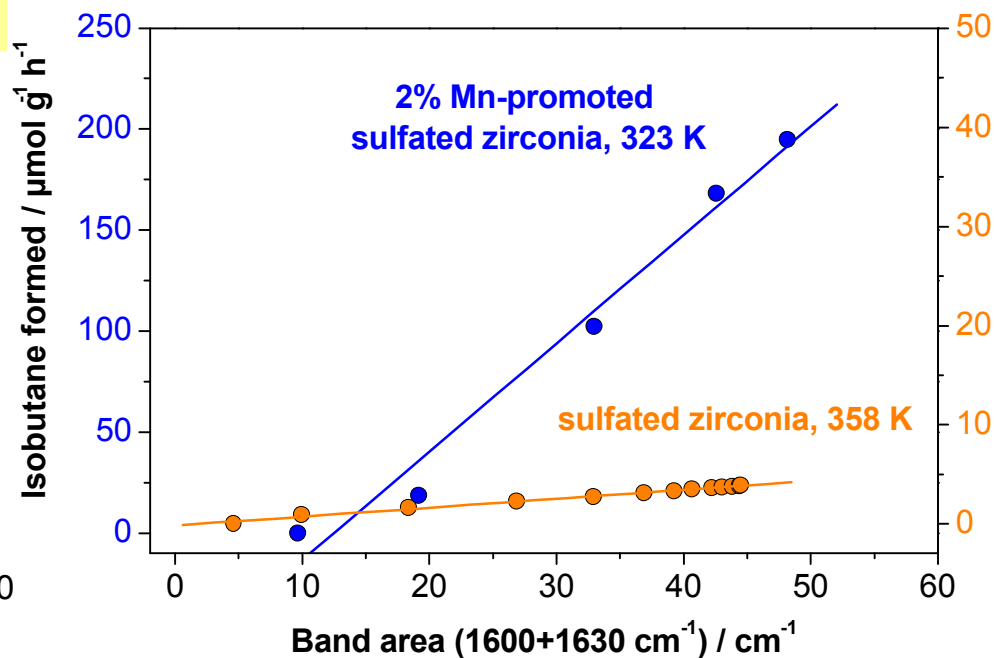
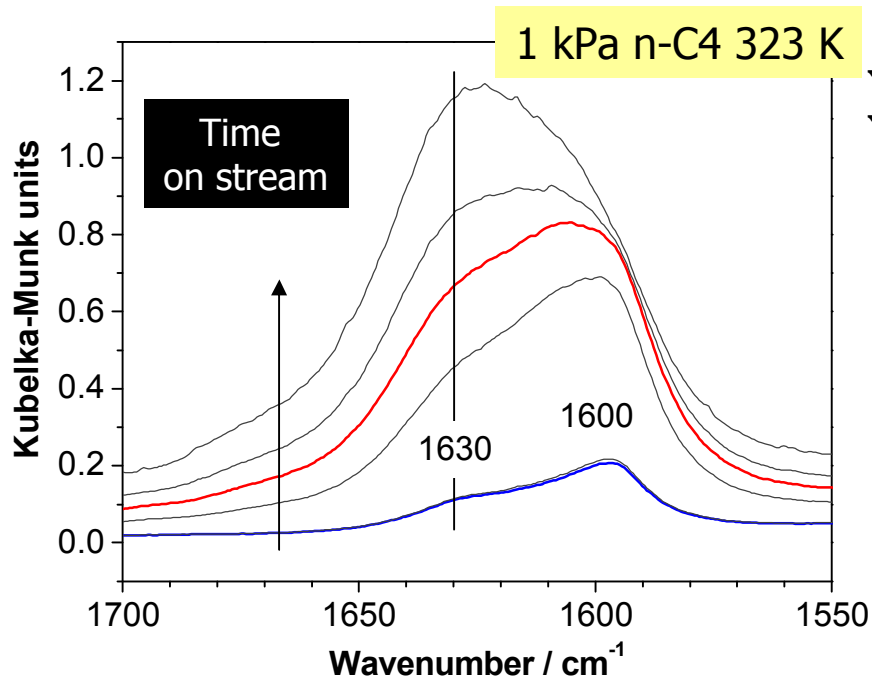

- ❖ bands at 1600 and 1630 cm^{-1} increase
- ❖ also range of C=C stretching vibrations, but corresponding CH vibrations not observed
- ❖ water bending vibration

- ❖ Rate of isomerization proportional to the amount of water formed (induction period)

Fiber Optics

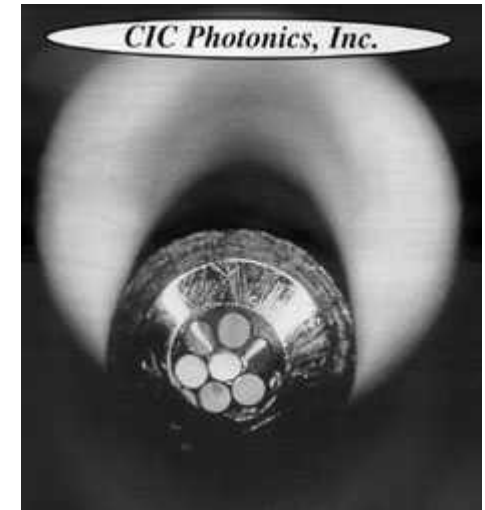
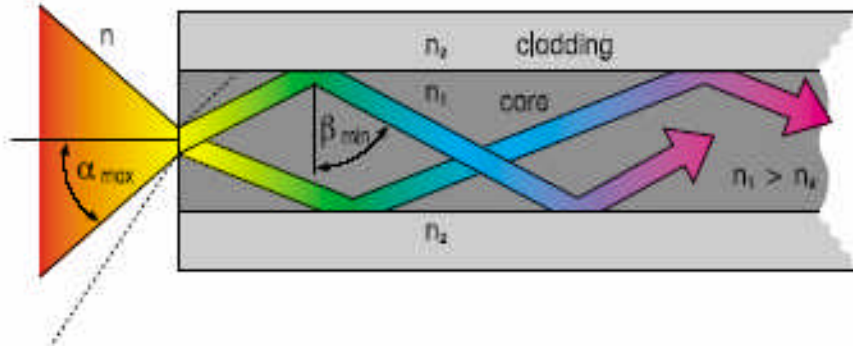

- ❖ light conducted through total reflectance
- ❖ 6 around 1 configuration: illumination through 6 (45°), signal through 1 avoids collection of specularly reflected light

pictures: Hellma (<http://www.hellma-worldwide.de>) and CICP (<http://www.cicp.com/home.html>)

Fiber Optics

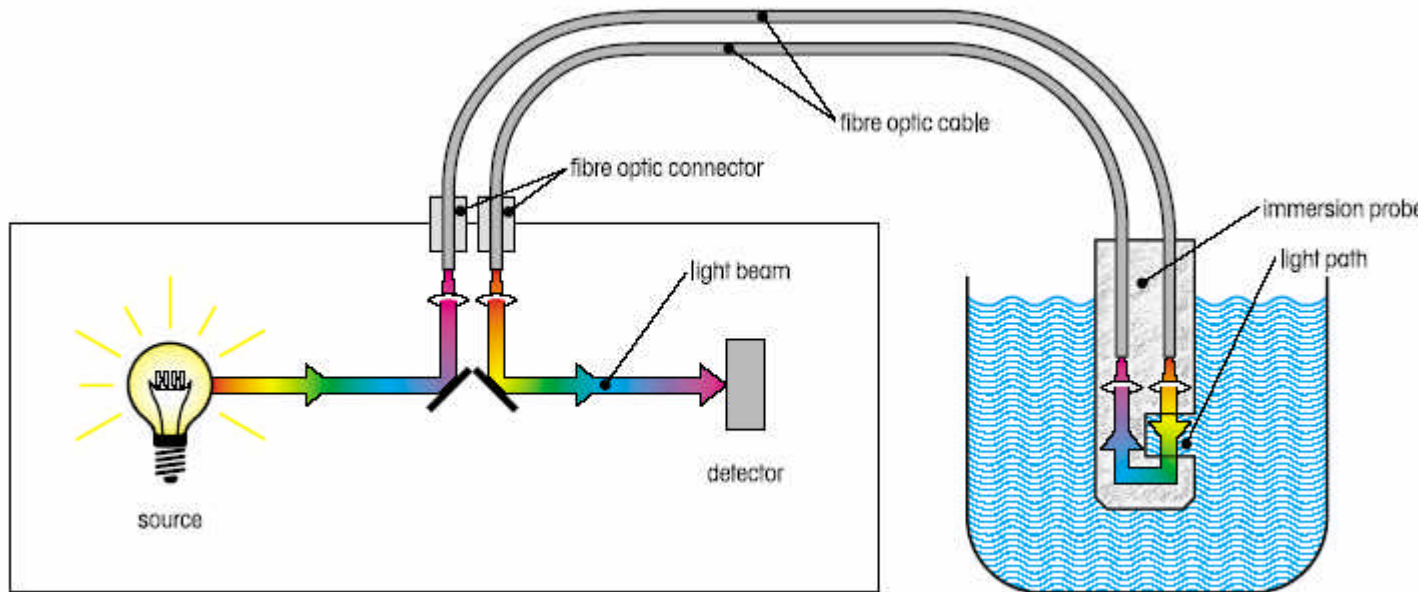

- ❖ fibers need to be coupled into spectrometer beam bath
- ❖ problems: losses at couplers

picture: Hellma (<http://www.hellma-worldwide.de>)

example shows transmission fiber

Summary

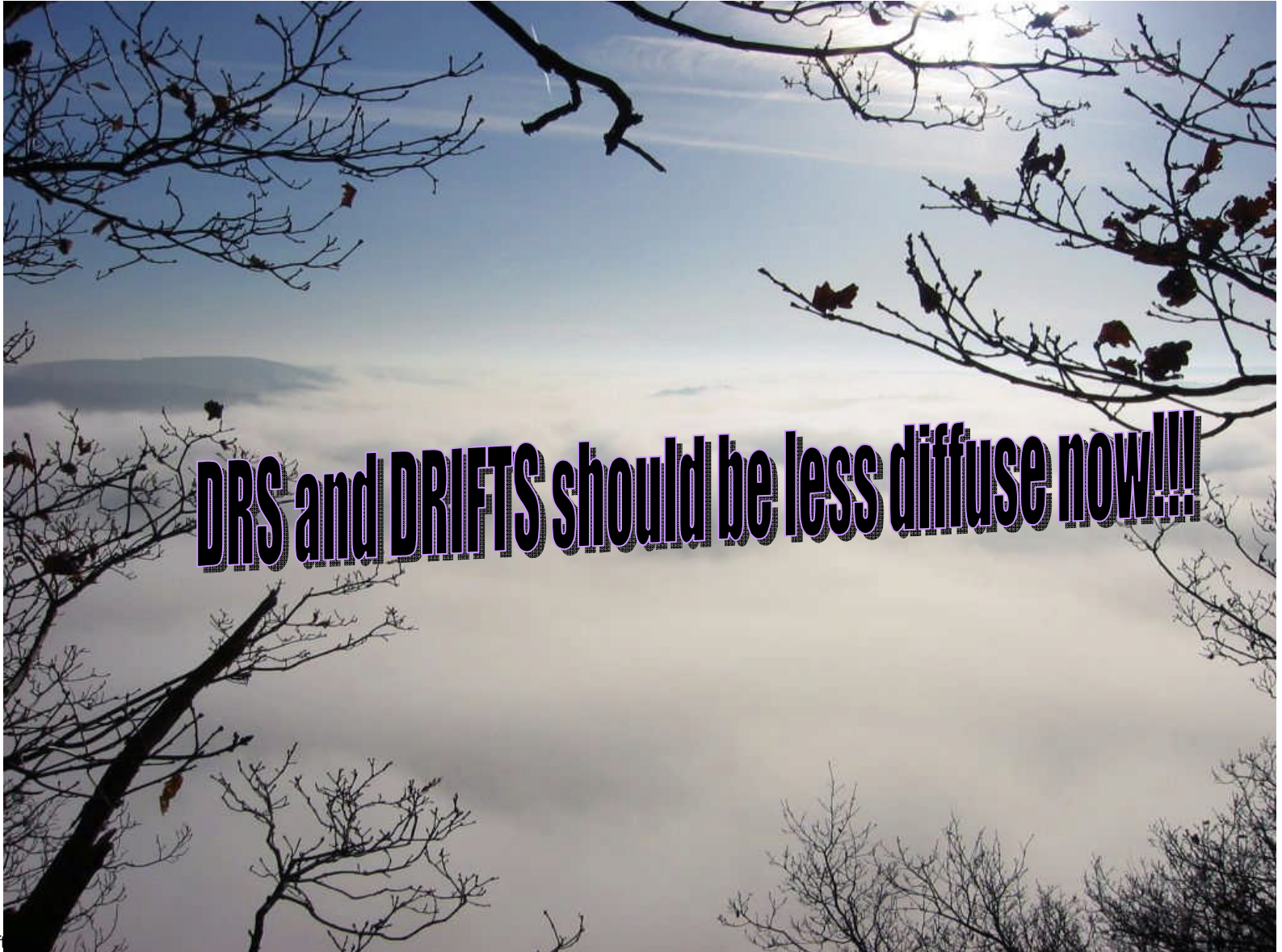

Literature

- ❖ W. WM. Wendlandt, H.G. Hecht, "Reflectance Spectroscopy", Interscience Publishers/John Wiley 1966, [FHI: 22 E 13](#)
- ❖ G. Kortüm, "Reflectance Spectroscopy" / "Reflexionsspektroskopie" Springer 1969, [FHI: missing](#)