

# JVC<sup>®</sup>

## COLOUR VIDEO CAMERA

---

# TK-C1480 TK-C1481

## INSTRUCTIONS



**For Customer Use:**

Enter below the Serial No. which is located on the body. Retain this information for future reference.

Model No. **TK-C1480, TK-C1481**

Serial No. \_\_\_\_\_

## IMPORTANT SAFEGUARDS

1. Read all of these instructions.
2. Save these instructions for later use.
3. All warnings on the product and in the operating instructions should be adhered to.
4. Unplug this appliance system from the wall outlet before cleaning. Do not use liquid cleaners or aerosol cleaners. Use a damp cloth for cleaning.
5. Do not use attachments not recommended by the appliance manufacturer as they may cause hazards.
6. Do not use this appliance near water - for example, near a bathtub, washbowl, kitchen sink, or laundry tub, in a wet basement, or near a swimming pool, etc.
7. Do not place this appliance on an unstable cart, stand, or table. The appliance may fall, causing serious injury to a child or adult, and serious damage to the appliance.

Use only with a cart or stand recommended by the manufacturer, or sold with the appliance. Wall or shelf mounting should follow the manufacturer's instructions, and should use a mounting kit approved by the manufacturer. An appliance and cart combination should be moved with care.

Quick stops, excessive force, and uneven surfaces may cause the appliance and cart combination to overturn.

8. Slots and openings in the cabinet and the back or bottom are provided for ventilation, and to insure reliable operation of the appliance and to protect it from overheating, these openings must not be blocked or covered. The openings should never be blocked by placing the appliance on a bed, sofa, rug, or other similar surface.  
This appliance should never be placed near or over a radiator or heat register. This appliance should not be placed in a built-in installation such as a bookcase unless proper ventilation is provided.
9. This appliance should be operated only from the type of power source indicated on the marking label. If you are not sure of the type of power supplied to your home, consult your dealer or local power company. For appliance designed to operate from battery power, refer to the operating instructions.
10. This appliance system is equipped with a 3-wire grounding type plug (a plug having a third (grounding) pin). This plug will only fit into a grounding-type power outlet. This is a safety feature. If you are unable to insert the plug into the outlet, contact your electrician to replace your obsolete outlet. Do not defeat the safety purpose of the grounding plug.
11. For added protection for this product during a lightning storm, or when it is left unattended and unused for long periods of time, unplug it from the wall outlet and disconnect the antenna or cable system. This will prevent damage to the product due to lightning and power-line surges.
12. Do not allow anything to rest on the power cord. Do not locate this appliance where the cord will be abused by persons walking on it.

PORTABLE CART WARNING  
(symbol provided by RETAC)



S3126A

13. Follow all warnings and instructions marked on the appliance.
14. Do not overload wall outlets and extension cords as this can result in fire or electric shock.
15. Never push objects of any kind into this appliance through cabinet slots as they may touch dangerous voltage points or short out parts that could result in a fire or electric shock. Never spill liquid of any kind on the appliance.
16. Do not attempt to service this appliance yourself as opening or removing covers may expose you to dangerous voltage or other hazards. Refer all servicing to qualified service personnel.
17. Unplug this appliance from the wall outlet and refer servicing to qualified service personnel under the following conditions:
  - a. When the power cord or plug is damaged or frayed.
  - b. If liquid has been spilled into the appliance.
  - c. If the appliance has been exposed to rain or water.
  - d. If the appliance does not operate normally by following the operating instructions. Adjust only those controls that are covered by the operating instructions as improper adjustment of other controls may result in damage and will often require extensive work by a qualified technician to restore the appliance to normal operation.
  - e. If the appliance has been dropped or the cabinet has been damaged.
  - f. When the appliance exhibits a distinct change in performance - this indicates a need for service.
18. When replacement parts are required, be sure the service technician has used replacement parts specified by the manufacturer that have the same characteristics as the original part. Unauthorized substitutions may result in fire, electric shock, or other hazards.
19. Upon completion of any service or repairs to this appliance, ask the service technician to perform routine safety checks to determine that the appliance is in safe operating condition.

# Safety Precautions

## FOR USA AND CANADA



### CAUTION

RISK OF ELECTRIC SHOCK  
DO NOT OPEN



CAUTION: TO REDUCE THE RISK OF ELECTRIC SHOCK, DO NOT REMOVE COVER (OR BACK). NO USER-SERVICEABLE PARTS INSIDE. REFER SERVICING TO QUALIFIED SERVICE PERSONNEL.



The lightning flash with arrowhead symbol, within an equilateral triangle is intended to alert the user to the presence of uninsulated "dangerous voltage" within the product's enclosure that may be of sufficient magnitude to constitute a risk of electric shock to persons.



The exclamation point within an equilateral triangle is intended to alert the user to the presence of important operating and maintenance (servicing) instructions in the literature accompanying the appliance.

## Information for USA

This device complies with part 15 of the FCC Rules. Changes or modifications not approved by JVC could void the user's authority to operate the equipment.

Due to design modifications, data given in this instruction book are subject to possible change without prior notice.

## WARNING:

**TO REDUCE THE RISK OF FIRE OR ELECTRIC SHOCK, DO NOT EXPOSE THIS APPLIANCE TO RAIN OR MOISTURE.**

## AVERTISSEMENT:

**POUR EVITER LES RISQUES D'INCENDIE OU D'ELECTROCUTION, NE PAS EXPOSER L'APPAREIL A L'HUMIDITE OU A LA PLUIE.**

## INFORMATION (FOR CANADA) RENSEIGNEMENT (POUR CANADA)

This Class B digital apparatus complies with Canadian ICES-003.

Cet appareil numérique de la Class B est conforme à la norme NMB-003 du Canada.

**Thank you for purchasing this product.**  
**(These instructions are for TK-C1480U, TK-C1480E and TK-C1481EG)**  
**Before beginning to operate this unit, please read the instruction manual carefully in order to make sure that the best possible performance is obtained.**

## CONTENTS

### INTRODUCTION

Features .....	6
Operating Precautions .....	7
Controls, Connectors and Indicators .....	8

### CONNECTION/INSTALLATION

RM-P2580 System .....	12
Procedures .....	14
Mounting the lens .....	15
Connections on the back .....	16
Mounting the camera .....	18
Lens adjustment .....	20
Back focus adjustment .....	21
Auto white balance control adjustment .....	22

### MENU SETTING

Setting the menu .....	23
The flow of menu screen .....	24
SYNC ADJUST Screen .....	26
ALC SETTINGS Screen .....	26
VIDEO ADJUST Screen .....	30
MODE SELECT Screen .....	31
MOTION DETECT Screen .....	31
COMMUNICATION Screen .....	33
FACTORY SETTINGS Screen .....	33
BLC EDITTING Screen .....	34
Manual Adjustment of White Balance .....	35
CAMERA TITLE Setting .....	36
Setting the MOTION DETECT Function .....	37

### OTHERS

Installing the ferrite core .....	38
Specifications .....	38

# INTRODUCTION

## Features

- A new DSP (Digital Signal Processor) features a Extended Dynamic Range (ExDR) and enables to shoot both bright and dark locations.
  - The use of a new CCD with a SENSE UP (X32) function realized the minimum luminous flux density for subject of 0.8 lx (F1.2, 50%, AGC 20dB) and 0.025 lx (at slow shutter).
  - A motion detector function detects the motion inside an image and emits alarm signals.
  - The equipped Y/C terminals and RS-422A/RS-485 terminals allow intended compatibility with diversified systems.
- Before starting an important recording, be sure to perform a test recording in order to confirm that a normal recording is possible.
  - We do not accept liability for the loss of a recording in the case of it becoming impossible to record due to a problem in the video camera, VCR or video tape.
  - We do not accept liability for any damage to the camera in cases when it is dropped because of incomplete installation due to not observing the installation instructions correctly. Please be careful when installing the camera.
  - The motion detector is not a feature to prevent theft, fire, etc. Even if an accident should occur resulting in damage, we do not accept any liability.

Characters and symbols used in this instruction manual.

**CAUTION** : Cautionary notes concerning operation of the unit.

**MEMO** : Reference such as restrictions of features, etc.

 : Reference page or item.

---

## Operating Precautions

- To save energy, when it is not being used turn the system's power off.
- This camera has been designed for indoor use. When you use it outdoor, be sure to use a housing and the like.
- Do not install or use the camera in the following places.
  - In a place exposed to rain or moisture.
  - In a place with vapor or oil soot, for example in a kitchen.
  - When the ambient temperature rises above or falls below the acceptable range (from  $-10^{\circ}\text{C}$  to  $50^{\circ}\text{C}$ ).
  - Near a source of radiation, X-rays, strong radio waves or magnetism.
  - In a place subject to vibration.
  - In a place with excessive dirt.
- If this camera and the cables connected to this camera are used where there are strong electromagnetic waves or where there is magnetism present, for example near a radio or TV transmitter, power transformer or an electric motor, the picture may produce noise and the colours may be affected.
- This camera incorporates an AGC circuit. As a result, when it is used under low light conditions, the camera sensitivity is automatically boosted and the picture may look uneven. However, this is not a malfunction.
- When this camera is used in the ATW mode, the recorded colours may be slightly different from the actual colours due to the operational principles of the auto-tracking white balance circuit. However, this is not a malfunction.
- If a high-intensity object (such as a lamp) is shot, the image on the screen may have vertical lines (smear) or blur (blooming) at its periphery. This is a characteristic of the CCD, and is not a defect.
- Observe the following when carrying out camera maintenance.
  - Turn the power OFF before proceeding to carry out maintenance.  
If it is contaminated seriously, clean the contaminated part with a cloth (or a tissue) which has been soaked in a solution of water and a neutral detergent.
- TK-C1480U and TK-C1480E  
The unit is to be powered by a DC 12 V or an AC 24 V power supply.  
The AC 24 V power supply should conform to the following:  
TK-C1480U Class 2 only  
TK-C1480E Isolated power supply only  
TK-C1481EG Connect the power cable to the commercial power supply of 230V.
- Caution for operating the video iris lens  
In case the video iris lens is set to an extremely low level, malfunction – such as the hunting phenomenon in which the iris opens or closes unintentionally – can occur.  
In such a case, first set the “LEVEL” potentiometer on the lens to the H position (iris open), and then adjust it to an optimum level.
- A CCD is made by high technology, boasting an exceptionally high level of precision with an effective pixel of more than 99.99%. Although there is a less than 0.01% pixel defect (whitish flaw, blackish flaw), this does not mean that the CCD is out of order.
- The cable stopper on the terminal block can come off sometimes. Therefore, be sure to take enough time and fix the cable securely.
- When a highly bright subject is shot, sometimes undulations can be observed on the vertical lines of the subject. However, this phenomenon is peculiar to the unit and is not a sign of malfunction.

# INTRODUCTION

## Controls, Connectors and Indicators

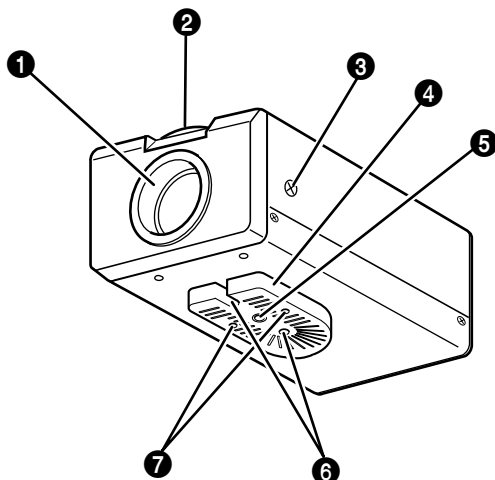

### 1 Lens mount

This means to attach the lens.  
This is applicable to both the C-mount lenses and CS-mount lenses.

### 2 Backfocus adjustment ring

Adjusting the back focus during lens installation.

When readjustment is required, loosen the locking screw 3 by turning it counterclockwise and turn the back focus adjustment ring 2.

After the adjustment, tighten the locking screw 3 again.

### 3 [BF LOCK] Back focus locking screw

This serves to fix the back focus-adjusting ring.

### 4 Camera-mounting bracket

The bracket has been attached on the bottom of the camera before shipment. It can also be attached on the top according to the circumstance.

To re-attach the bracket use the threaded holes at the top, with the camera mounting bracket locking screws 7.

### 5 Camera-mounting screw hole (1/4 inch)

Use this hole when mounting the camera onto a fixer, pan/tilt unit, and the like. (Use a screw shorter than 7 mm.)

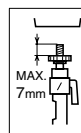

### 6 Rotation-preventive hole

Make use of this rotation-preventive hole to prevent any fall when mounting the camera. Make sure that the camera is securely mounted.

### 7 Camera mounting bracket fixing screws (x2: M2.6 x 6 mm)

Be sure to use a 6 mm long screw.



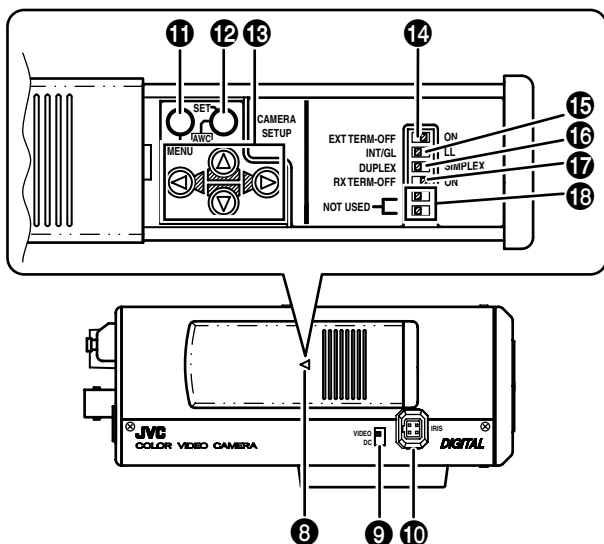

**8 Cover**

The cover opens if it is pulled to the left while being pushed.

**9 [VIDEO/DC] Iris Selector Switch**

This is set according to the type of lens when an automatic iris control lens is used.

**VIDEO:** In case of lens with EE amp built-in.

**DC:** In case of lens without EE amp built-in.

(At time of factory shipment  
 VIDEO: TK-C1480E and TK-C1481EG)  
 DC: TK-C1480U

**10 [IRIS] Iris Terminal**

This is connected to an automatic iris control lens.

(☞ Page 15)

**11 [MENU] Menu Button**

When the button is pressed, a menu

screen is brought up.

(☞ Page 23)

**12 [SET/AWC] Set. Auto White Control Button**

**SET:** Press this button to display a sub-menu.

(☞ Page 23)

**AWC:** If this button is kept pressed for more than 1 second, a one-push-auto-white-balance function works and sets the white balance. Once it is set, even if colour temperature changes, white balance does not change. It is also possible to make fine adjustments on the set white balance.

(☞ Page 22)

# INTRODUCTION

## Controls, Connectors and Indicators (Continued)

### 13 [⏮, ⏪, ⏩, ⏭] Up-and-down, left-and-right Button

These buttons select items on the menu screen and change a set value.

(☞ Page 23)

### 14 [EXT.TERM-ON/OFF] Terminal On/Off Switch of External Synchronization Signal

This is a terminating ON/OFF switch for the external synchronization input signal. When this is switched ON, termination is executed via a 75 Ω resistor.

**ON:** terminates at 75Ω.

**OFF:** does not terminate at 75Ω.

(ON: At time of factory shipment)

### 15 [INT/GL, LL] Selector Switch for Synchronizing System

This switch can set a synchronizing system of the camera.

**INT/GL:**

This is set for internal synchronization (INT) or external synchronization (GL).

**LL (Line Lock):**

The camera's vertical synchronization is locked to the AC 24V power line frequency. When switching between multiple cameras using a switcher, selecting this mode and adjusting the vertical phase can reduce the monitor sync disturbances occurring when the camera image is switched. (This cannot be used in regions where the power frequency is 60 Hz (50 Hz ( ):TK-C1480U)  
(INT/GL: At time of factory shipment)

### 16 [DUPLEX, SIMPLEX] Selector Switch for Transmission System

If the setting is changed, be absolutely sure to switch on the power again.

**DUPLEX:**

This switch sets to DUPLEX when the transmission between the camera and a remote control unit is in a duplex system (two-way).

**SIMPLEX:**

This switch sets to SIMPLEX when the transmission between the camera and a remote control unit is in a simplex system (one-way).

(DUPLEX: At time of factory shipment)

### 17 [RX.TERM-ON/OFF] RX Signal Terminal ON/OFF Switch

This sets whether or not the signal between RX + and RX – on the back 20 should be terminated at the value of 110Ω resistance.

**ON:** terminates.

**OFF:** does not terminate.

If the system including the camera is the M.DROP (Multi-drop, RS-485) system, only the camera mounted at the terminal of control signal cable is set to "ON" and the other camera is set to "OFF". In case of the M.DROP system, it becomes necessary to set the Machine ID. (☞ Page 33)

If the system including the camera is the P TO P (Point to Point, RS-422A) system, set this switch of all the cameras to "ON". The item STYLE on the COMMUNICATION screen sets M.DROP or P TO P (☞ Page 33)

(ON: At time of factory shipment)

### 18 NOT USED

This cannot be used. Do not switch.

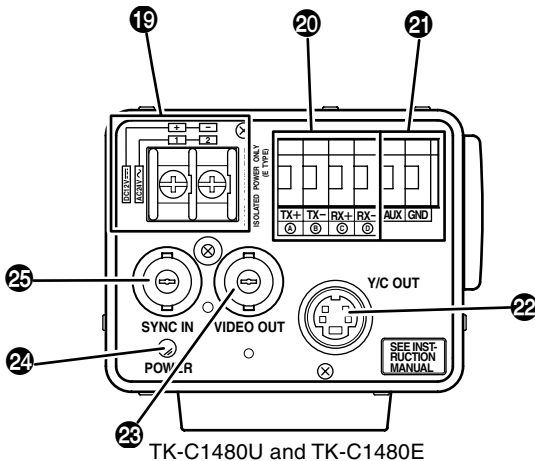

TK-C1480U and TK-C1480E

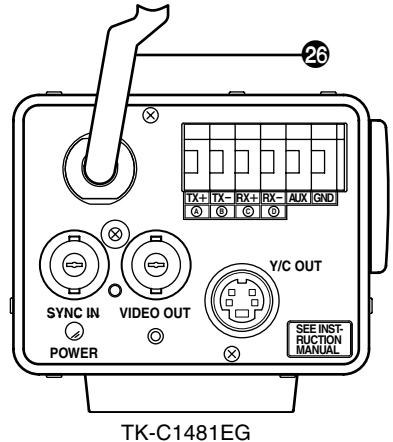

TK-C1481EG

**19 [DC 12V, AC 24V] Power input terminals (TK-C1480U and TK-C1480E)**

To input DC 12V or AC 24V power.

**20 [TX+<sup>A</sup>, TX-<sup>B</sup>, RX+<sup>C</sup>, RX-<sup>D</sup>] Control signal connection terminals**

Terminals for inputting signals with electrical characteristics conforming to the EIA/TIA RS-422A or RS-485 standard.

☞ **17** RX.TERM switch

**21 [AUX, GND] Auxiliary Output Terminals**

If any change occurs in the area that was set on the MOTION DETECT screen, these terminals output signals. (☞ Page 31)

[Open-collector Low signal. Maximum voltage 30V, Current 30mA.]

**22 [Y/C OUT] Y/C output connector**

This 4-pin connector outputs the luminance and chrominance signal.

• Pin configuration of Y/C OUT connector



Pin No.	Signal
1	GND
2	GND
3	Luminance (Y)
4	Chrominance (C)

**23 [VIDEO OUT] Video signal output connector**

This BNC connector outputs a composite video signal. Connect this to the video input connector of a video monitor, switcher, etc.

**24 [POWER] Power indicator lamp**

This lamp lights when power is supplied to the camera.

**25 [SYNC IN] Sync signal input connector**

This BNC connector accepts the input of an external sync signal such as a composite video (VBS) or black burst (BB) signal.

When a sync signal is input into this connector, the camera operation is automatically synchronized with the external sync signal.

To terminate this connector at 75Ω, turn ON the EXT.TERM switch **14**.

**26 Power cable (TK-C1481EG)**

Connect to the commercial AC230V outlet

# CONNECTION/INSTALLATION

## RM-P2580 System

### ■ System with up to 8 cameras

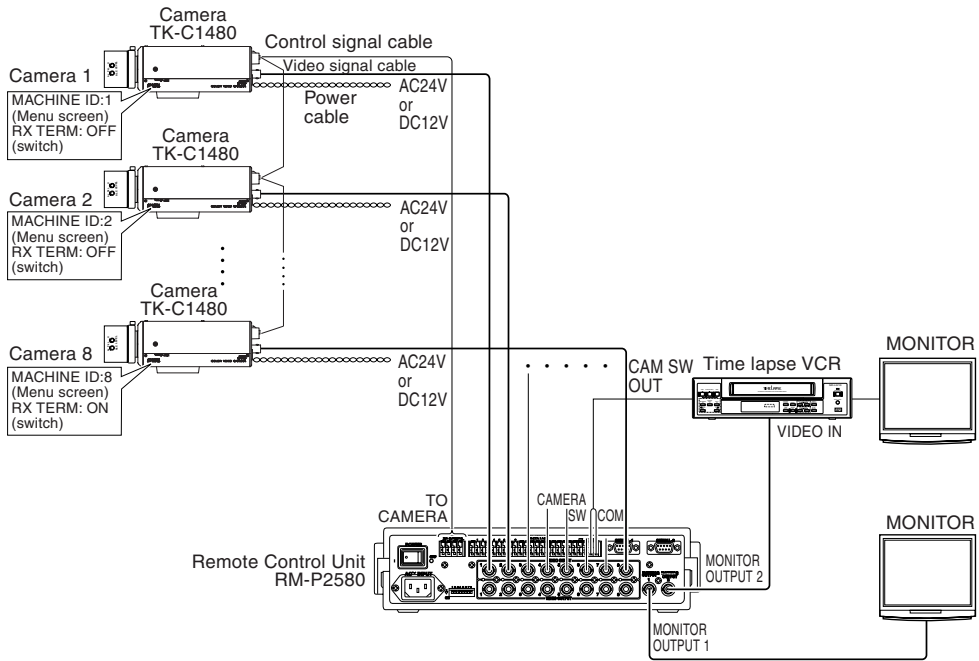

This is the connected example of the TK-C1480U or TK-C1480E.

When controlling with any system except the RM-P2580, execute proper settings using switches and menu screens according to the systems used. (☞ Page 14)

#### MEMO

- When operating a system using the RM-P2580, several cameras (up to 8) can be connected and used on one control signal cable. Consequently, an incorrect switch setting on just a single camera will cause the entire system to work incorrectly.

- Confirm switch settings on the screen as follows.

- ① Confirm that the image from the camera to be checked is displayed on the monitor.
- ② Turn OFF and then ON the AC 24 V power to the camera to be checked.
- ③ The camera begins the initial operation and characters similar to those shown in the illustration on the right appear on the monitor screen.
- ④ Confirm that "DUPLEX" and "ID-□□" are displayed and that the ID number is the correct number (the number should be the same as the number of the VIDEO INPUT terminal to which the camera is connected on the rear panel of the RM-P2580).
- ⑤ If wrong, set the camera ID again.

MONITOR screen  
(example showing camera ID as "05")

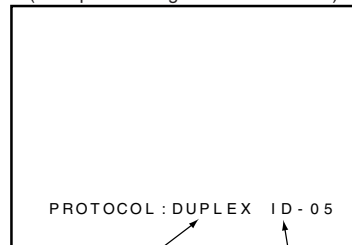

"DUPLEX" should be displayed.

The number shown in the □□ part of ID-□□ should be correct.

## ■ Connecting the control signal cable

(Use a twisted-pair cable for connection.  Page 17.)

Camera 1

control signal  
connection terminals

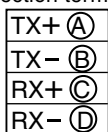

RM-P2580

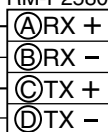

Camera 2  
control signal  
connection terminals

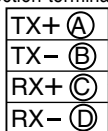

Connect:

Camera TX+ to RM-P2580 RX+

Camera TX- to RM-P2580 RX-

Camera RX+ to RM-P2580 TX+

Camera RX- to RM-P2580 TX-

The (A) (B) (C) (D) marks indicated on both the camera terminals and the RM-P2580 terminals facilitate correct connections. Connect the terminals with identical marks.

## ■ Setting the switches Page 10)

Select the synchronization method of the camera image.

Set the switch on all cameras to LL (Line Lock) and match with the V. PHASE.

( Page 26.)

Set this switch to the DUPLEX

\* If the setting is changed, be absolutely sure to switch on the power again.

Set this switch to ON (signal termination ON) only on the camera placed at the end of the control signal cable.

Set to OFF on all other cameras.

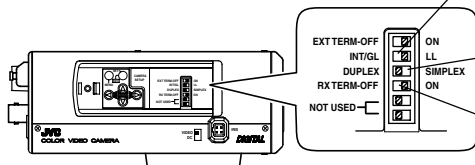

## ■ Setting on the MENU screen Page 33)

\* If the setting is changed, escape from the menu screen once, and definitely switch on the power again.

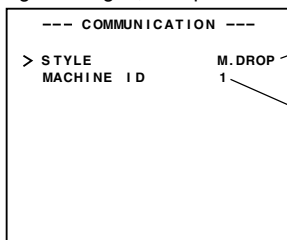

**Set to M.DROP**

Set to M.DROP when the RM-P2580 is used as a remote control unit. When controlling from another machine, make sure that it matches the communication system used.

**MACHINE ID setting switches**

Set this item to match the RM-P2580 VIDEO INPUT terminal number for each camera.

### When connecting

- Turn OFF the power supply to all equipment to be used before making connections.
- Carefully read the Instructions for each piece of equipment to be used before making connections.
- For the appropriate connection cables and the length of these, carefully read “Connections on the back” on page 16.
- The control signal cable cannot be used for loop connection.

# CONNECTION/INSTALLATION

## Procedures

Execute connection/installation according to the procedures described below.  
Turn OFF the power supply to all equipment to be used before making carefully.

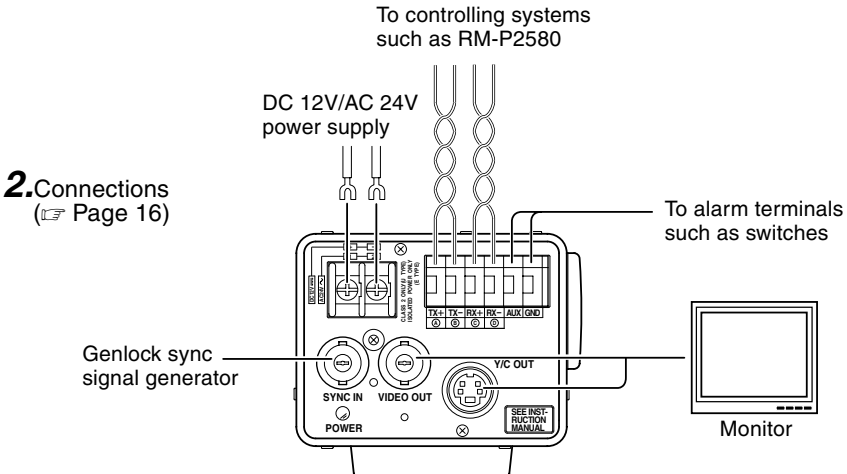
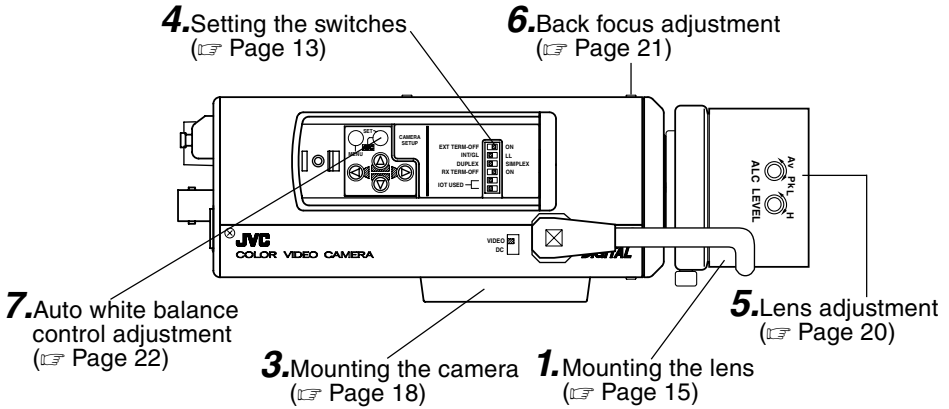

This is the connected example of the TK-C1480U or TK-C1480E.  
TK-C1481EG (☞ Page 16)

## Mounting the lens

Mount the lens according to the procedures described below.

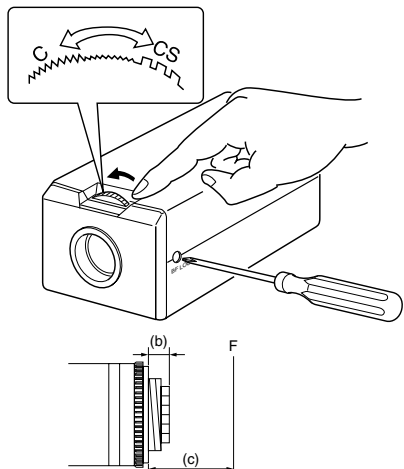

1. Before mounting a lens, check whether it is a C-mount or CS-mount lens.

To change the mounting method, loosen the back-focus locking screw (M 2.6) using a Phillips head screwdriver, turn the back-focus adjusting ring with your fingers or the screwdriver and change the mounting method.

Dimension (b) of the lens shown in the illustration must be as shown in the table below. If (b) exceeds the value in the table, it may damage the inside of the camera or correct mounting may be impossible; never use such lenses. Do not attach the C-mount lens when using a CS-mount.

Lens	Flange back (c)	Dimension (b)
C mount lens	17.526mm	10mm or less
CS mount lens	12.5mm	5.5mm or less

The F mark indicates a focal point.

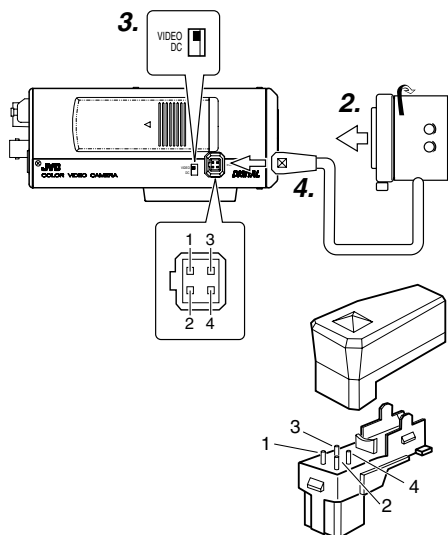

2. Mount the lens on the camera by turning the lens clockwise. Adjust its position.
3. When using an auto-iris lens with an EE amplifier, turn the switch to the "VIDEO" side. When no EE amplifier is equipped, turn the switch to the "DC" side.
4. If the lens has an auto-iris mechanism, connect the lens cable after checking the pin arrangement. If the lens cable has a different type of plug, use the 4-P plug supplied.

Attached 4 pin plugs

Pin No.	Lens	DC IRIS (does not contain EE amplifier)	VIDEO IRIS (contain EE amplifier)
1		Brake ⊖	9V [max 50mA]
2		Brake ⊕	NC
3		Drive ⊕	VIDEO
4		Drive ⊖	GND

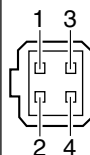

# CONNECTION/INSTALLATION

## Connections on the back

### ■ Power supply

TK-C1480U and TK-C1480E (DC 12V or 24V)

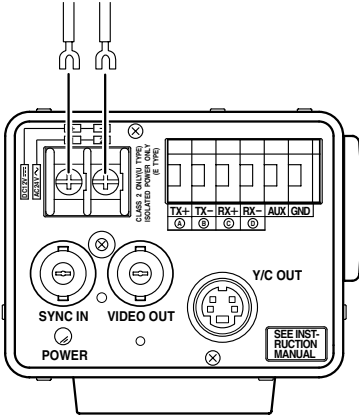

Connect the DC 12 V or the AC 24 V power supply to the DC 12V/AC 24V terminals. To prevent connection errors or a cable disconnection, we recommend the use of lug plates for the connections.

The following table shows the connection distances and connection cables provided that 2-conductor VVF cables (vinyl-insulated vinyl sheath cables) are used.

Maximum extension (reference)	100 m	260 m	410 m	500 m
Conductor diameter	1.0Ømm and more	1.6Ømm and more	2.0Ømm and more	2.6Ømm and more

### MEMO

- If thin cables are used (i.e. with a high resistance), a significant voltage drop will occur when the unit is at its maximum power consumption. Either use a thick cable to restrict the voltage drop at the camera side to below 10%, or place the power supply near to the camera. If voltage drop occurs during operation, the performance will be unstable.
- Attach the cable conductors so that they do not come into contact with the drop prevention wires.
- Do not allow input from both a DC 12 V and AC 24 V power supply at the same time.
- When using a DC 12 V power supply, ensure that the polarities of the cable are correct.
- The AC 24 V power supply should conform to the following:  
TK-C1480U Class 2 only  
TK-C1480E Isolated power supply only

### TK-C1481EG (AC230V)

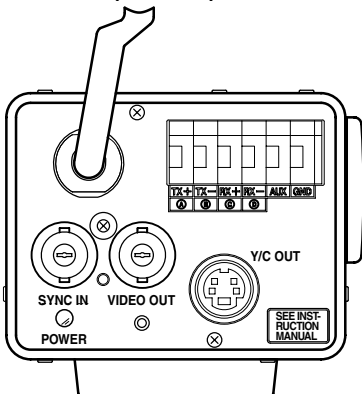

Power cable connect to the commercial AC230V outlet

### CAUTION:

When you use this camera, the socket-outlet shall be installed near equipment so as to disconnect easily.



---

## ■ Control signal cables

These cables should be connected only when it is required to control the camera using the RS-442A or RS-485 signals. The use of 0.65 4-conductor twisted pair cables is recommended. With these cables, the maximum extension distance is 1,200 m.

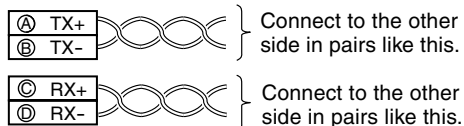

## ■ Genlock connection

With some systems, when the external sync signal is a composite video or black burst signal genlocking by applying an external sync input requires the horizontal phase (H PHASE) and colour phase (SC COARSE) to be adjusted.

---

### MEMO

---

- Genlocking is not possible with a signal containing too much jitter, such as a VCR or videodisc playback signal.
- For details, consult a JVC authorized dealer.

# CONNECTION/INSTALLATION

## Mounting the camera

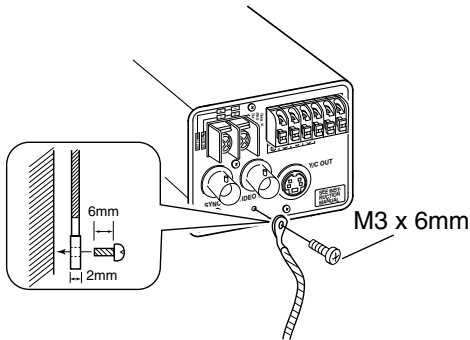
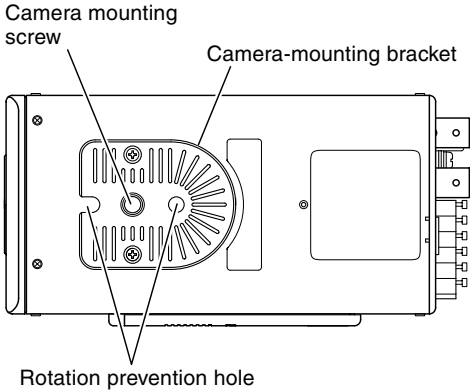

This diagram shows the installed example of the TK-C1480U or TK-C1480E. Be sure to install a fall preventive wire likewise in case of the TK-C1481EG.

When mounting the camera on a fixer, pan/tilt, etc., use the camera mounting screw hole located on the camera-mounting bracket.

### CAUTION:

Use the screw with a length shorter than 7mm from a camera-mounting face.

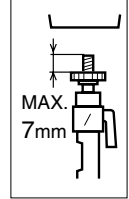

Furthermore, make use of the rotation prevention hole to prevent the camera from falling and securely mount the camera. Special precautions must be taken for mounting the camera on a wall or a ceiling. We are not liable for any damage caused by improper installation.

### Fall Prevention

- Exercise maximum caution when installing the unit to the wall or ceiling. You should not engage in the installation work yourself. Ask a professional to do the job, since the fall of the unit can result in injuries and accidents.
- When installing the unit on a fixer, Pan/Tilt unit, etc., make sure to install it firmly using a rotation-preventing hole provided to prevent fall.
- To prevent fall, connect the unit to a section with sufficient strength (ceiling slab or channel) using a fall prevention wire such as a wire chain and the like. Use the screw hole on the back of the unit for installation. Pay utmost attention to the length of the wire, too.
- Specified screw (M3 × 6 mm)  
Never use any screw longer than the specified length as the inside can be damaged.

①

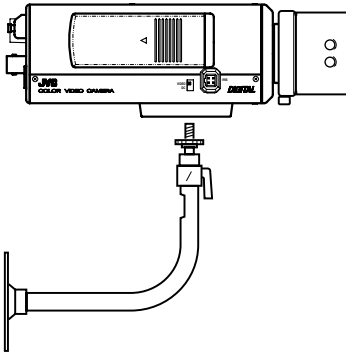

②

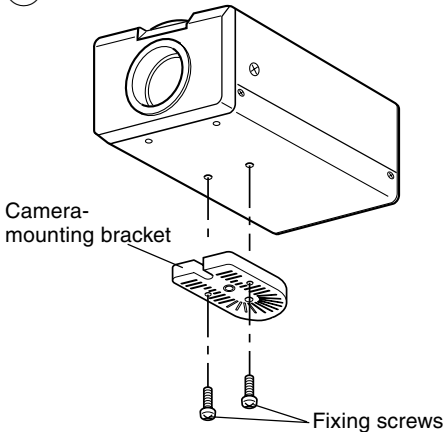

③

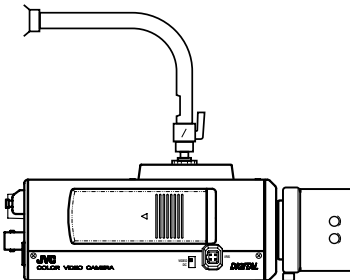

### Installation of camera

- Mounting from the bottom  
This camera is originally designed to be mounted from the bottom, as shown ①. The hole is standard photographic pan-head screw size (1/4-20 UNC). Example the Fixing unit or Pan/Tilt unit.
- Mounting from the top  
Remove the CAMERA MOUNTING BRACKET from the bottom of the camera by removing two fixing screws as shown ②. Attach the CAMERA MOUNTING BRACKET to the top, then mount the camera on the Fixing Unit as shown ③. Make sure that two original screws are used when mounting the CAMERA MOUNTING BRACKET. Be sure to use a 6 mm long locking screw for the camera-mounting bracket.  
(This camera is used indoor and under similar conditions.)

# CONNECTION/INSTALLATION

## Lens adjustment

Connect the camera according to the connection method, turn it on, display an image on the monitor, and check the image. The camera has been factory-adjusted to the best position, but it may need to be adjusted according to the object conditions or combination of lenses. If the image is unnatural, adjust it as follows: (Also read the instruction manual of the lens.)

LEVEL  
adjustment

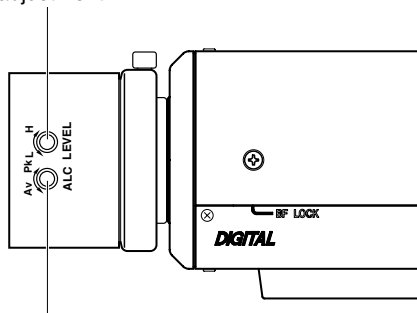

ALC adjustment  
(Does not operate.)

### MEMO

Note that the lens cannot make ALC adjustments. Make ALC adjustments using the item AVERAGE: PEAK on the menu.

(☞ Page 26)

### • LEVEL adjustment

Monitor screen	LEVEL turning direction
Too bright	Counterclockwise (Toward L)
Too dark	Clockwise (Toward H)

### MEMO

- If the sensitivity adjustment LEVEL is turned excessively to L, the sensitivity increases because of the AGC function of the camera, and the image looks grainy.
- If the video iris lens is set to too low a level, malfunction such as the hunting phenomenon, in which the iris opens or closes unintentionally, may occur.

In such a case, first set LEVEL potentiometer on the lens to the H (iris open) position then adjust it to the optimum level.

## Back focus adjustment

### ■ Back focus adjustment



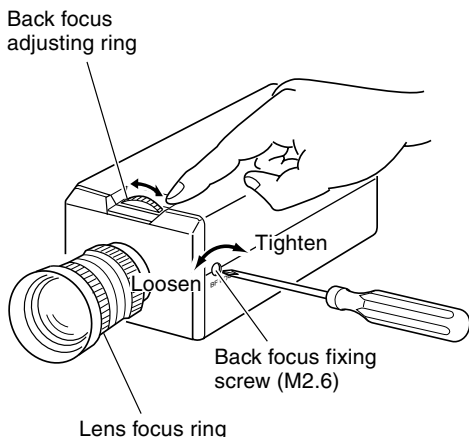

Be sure to make back-focus adjustments when changing the lens mounting method or using a different lens. If required, adjust it as follows:



#### MEMO

#### • LENS FOCUS ADJUSTMENT MODE

At the time of focus adjustment, press the button  at the side of the unit for at least one second to open the lens iris and to facilitate focusing. At this time, "LENS FOCUS ADJUSTMENT MODE" will be displayed on the monitor screen.

When the adjustment has been completed, press one of the buttons     to cancel focus adjustment mode.



- Focus setting can differ on the color and on the black and white screen. Make adjustments so that the focus will come to the optimum on both screens.

#### MEMO

When the subject is bright, the use of an ND filter permits more accurate back-focus adjustment. (The ND filter reduces the amount of incident light upon the lens equally over the entire range of wavelength.)



#### • With a fixed-focus lens

If the focus can not be adjusted correctly by rotating the lens focus ring, adjust the back focus as follows.

1. Loosen the back focus locking screw by turning it counterclockwise () with a screwdriver.
2. Shoot a pattern closely.
3. Turn the lens focus ring to  $\infty$ .
4. Turn the back focus adjustment ring to focus at the best point.
5. Tighten the back focus locking screw by turning it clockwise (.

#### • With a zoom lens

If the image is out of focus when zooming (telephoto wide-angle), adjust the camera as follows:

1. Loosen the back focus locking screw by turning it counterclockwise () with a screwdriver.
2. Shoot a comparatively dark scene with thin lines.
3. Set the lens to the maximum telephoto position, and adjust the lens focus.
4. Set the lens to the maximum wide-angle position, and turn the back focus ring to adjust the focus. (Repeat steps 3. and 4. two or three times.)
5. Tighten the back focus locking screw by turning it clockwise (

# CONNECTION/INSTALLATION

## Auto white balance control adjustment

Each light source has its own colour temperature. Therefore, when the main light source lighting an object is changed, the white balance should be adjusted again by pressing the AWC button.

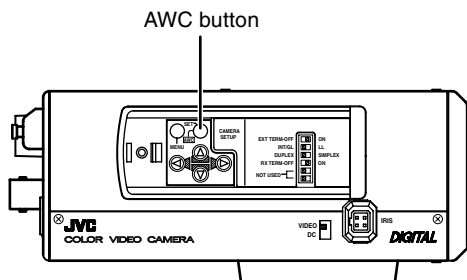

1. Place a white object under the same lighting condition as the object to be shot and zoom in to fill the screen with white.
2. When the AWC button is pressed for approx. one sec., the white balance is adjusted for the object being recorded.
3. During the time when the Auto White function is operated, "AWC OPERATION" is displayed (for approx. 0.5 sec.). When the appropriate white balance is acquired, "AWC OK" is displayed.

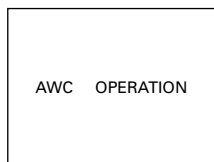

DURING OPERATION

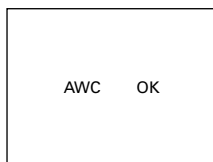

DISPLAYING RESULT

4. Error message display

- **NG : OBJECT**

Displayed when there is not enough white colour on an object or the colour temperature is not suitable.

By taking a shot of a white object to fill the screen, adjust the white balance again.

- **ERROR : LOW LIGHT**

Displayed when the light is low. Increase the illumination then re-adjust the white balance.

- **ERROR : HIGH LIGHT**

Displayed when the light is too bright. Decrease the illumination then re-adjust the white balance.

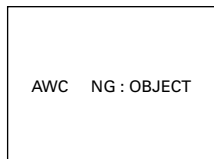

OBJECT ERROR

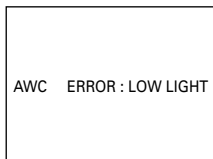

LOW LIGHTING

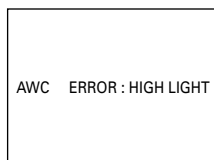

OVER LIGHTING

# MENU SETTING

## Setting the menu

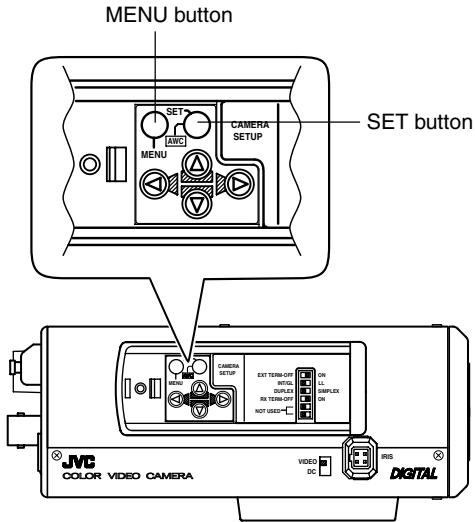

1. Press the MENU button.  
The MENU screen is displayed.
2. Set the cursor (>) to a desired sub-menu using the  $\triangle$ ,  $\nabla$  button.
3. Press the SET button.  
The selected sub-menu screen is displayed.

```

--- MENU ---
SYNC ADJUST..
> ALC SETTINGS..
VIDEO ADJUST..
MODE SELECT..
MOTION DETECT..
COMMUNICATION..
FACTORY SETTINGS..
    
```

```

--- ALC SETTINGS ---
> IRIS LEVEL      NORMAL
AVERAGE : PEAK   8 : 2
SHUTTER (ExDR)   NORMAL
AGC MODE         20 dB
LOLUX MODE       OFF
SENSE UP         OFF
PRIORITY         ---
BLC              OFF
    
```

4. Use the  $\triangle$ ,  $\nabla$  button to set the cursor (>) to a desired item.

```

--- ALC SETTINGS ---
> IRIS LEVEL      NORMAL
AVERAGE : PEAK   8 : 2
SHUTTER (ExDR)   NORMAL
AGC MODE         20 dB
LOLUX MODE       OFF
SENSE UP         OFF
PRIORITY         ---
BLC              OFF
    
```

5. Change the set value using the  $\triangleleft$ ,  $\triangleright$  button.  
Change of the set value displays a change mark (\*).

```

--- ALC SETTINGS ---
>*IRIS LEVEL      -5
AVERAGE : PEAK   8 : 2
SHUTTER (ExDR)   NORMAL
AGC MODE         20 dB
LOLUX MODE       OFF
SENSE UP         OFF
PRIORITY         ---
BLC              OFF
    
```

If you wish to change the set values of another items, repeat items 2. to 5. above.

6. Press the MENU button.  
The screen returns to the previous one (MENU screen).
7. Press the MENU button.  
The screen returns to the normal screen (quitting the menu display).

\* When the setting is executed using the RM-P2580, use a joy stick instead of the  $\triangle$   $\nabla$   $\triangleleft$   $\triangleright$  button.

# MENU SETTING

## The flow of menu screen

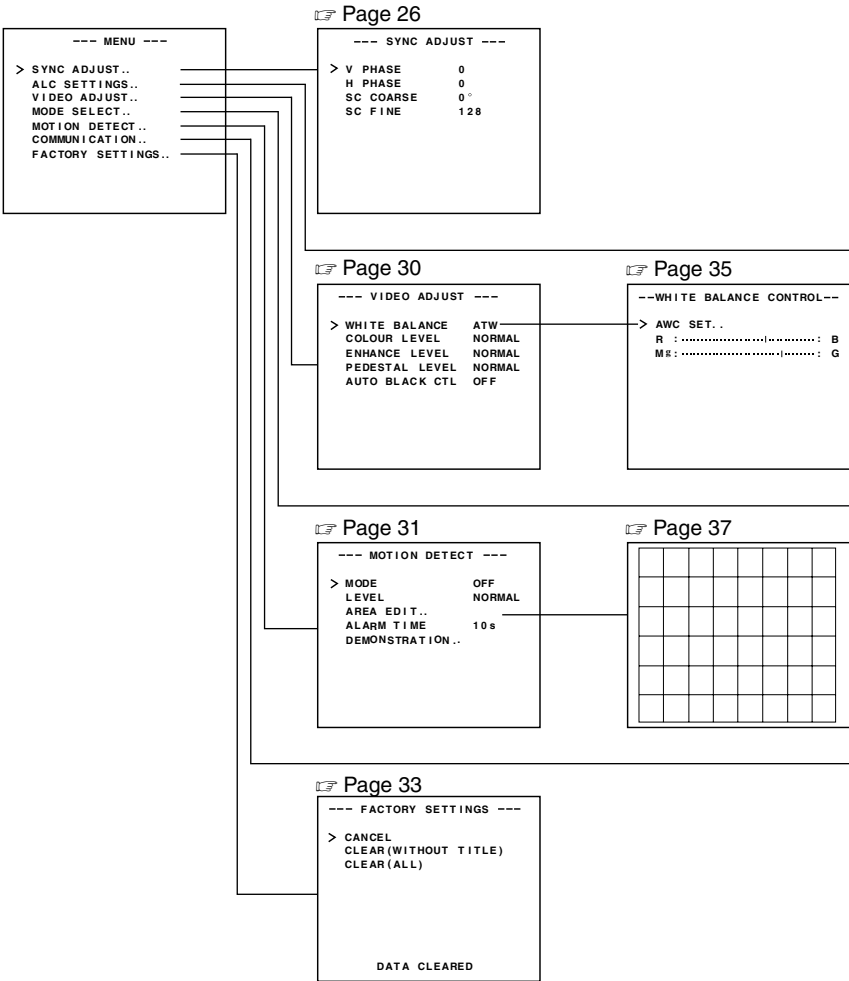

The word "COLOUR" is displayed as "COLOR" on the TK-C1480U.



Page 26

```

--- ALC SETTINGS ---
> IRIS LEVEL          NORMAL
  AVERAGE PEAK      8:2
  SHUTTER (ExDR)    NORMAL
  AGC MODE           20dB
  LOLUX MODE         OFF
  SENSE UP           OFF
  PRIORITY           ---
  BLC                OFF
  
```

Page 31

```

--- MODE SELECT ---
> CAMERA TITLE EDIT..
  REVERSE MODE       OFF
  ALM.TITLE SIZE     DOUBLE
  ALARM COLOUR       WHITE
  D.ZOOM MAX         x2
  
```

Page 33

```

--- COMMUNICATION ---
> STYLE              PTOP
  MACHINE ID         ---
  
```

```

--- SHUTTER (ExDR) ---
> SHUTTER SPEED      1/120
  FAST LIMIT         ---
  ExDR LEVEL         ---
  M.ExDR SPEED       ---
  
```

Page 34

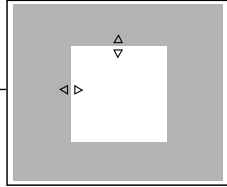

Page 36

```

--- CAMERA TITLE ---
0123456789.: / , .
ABCDEFGHIJKLMN O P
QRSTUVWXYZ
abcdefghijklmnop
qrstuvwxyz'
AOUAETOUÇN
àèiòùâéiôûâéiôû
âèiòùçñßiç

<-WIDE          TELE ->
  Title Display
  
```

(The TK-C1480U does not display these characters.)

# MENU SETTING

## SYNC ADJUST Screen

This executes the setting regarding synchronization.

Item	Functions and set values	Initial value
V PHASE	This adjusts the vertical synchronization to those of other cameras when a selector switch for the synchronizing system on the side is at LL. (50Hz (60Hz) power region only. ( ): TK-C1480U) When it is not set to LL, "---" will appear, disabling change the set value. TK-C1480U [Set value: -131 to 0 to 131] TK-C1480E and TK-C1481EG [Set value: -156 to 0 to 156]	0
H PHASE	This adjusts the horizontal synchronization to those of other cameras and systems when a selector switch for the synchronizing system on the side is at INT/GL. When external signals are not input, "---" will appear, disabling change the set value. [Set values: -16 to 0 to 16]	0
SC COARSE	Coarse adjustment of the SC phase in gen-lock operation. The SC phase can be varied by up to 90° in each direction. Adjust with reference to another camera (or system) and together with the SC FINE adjustment. Adjust SC COARSE and SC FINE only after adjusting H PHASE. When it is not set to GL, "---" will appear, disabling change the set value. [Set values: 0°, 90°, 180°, 270°]	0°
SC FINE	Fine adjustment of the SC phase in gen-lock operation. When it is not set to GL, "---" will appear, disabling change the set value. [Set values: 0 to 255]	128

## ALC SETTINGS Screen

This makes automatic adjustments according to brightness.

Item	Functions and set values	Initial value
IRIS LEVEL	Adjusts the brightness level of the video signal. <ul style="list-style-type: none"> <li>To lower the brightness level ... Decrease the value</li> <li>To raise the brightness level .... Increase the value</li> </ul> [Set values: -5 to NORMAL to 5]	NORMAL
AVERAGE: PEAK	Sets the exposure detection as a ratio of the average value and the peak value. <ul style="list-style-type: none"> <li>AVERAGE value large: Increase the AVERAGE value when portions other than the highlighted areas of the screen are dark and look corrupted. (Ex. 10:0)</li> <li>PEAK value large: Increase the PEAK value when halation occurs in the highlighted areas of the screen. (Ex. 5:5)</li> </ul> [Set values: 10:0, 9:1, 8:2, 7:3, 6:4, 5:5]	8 : 2

Item	Functions and set values	Initial value
SHUTTER (ExDR)	<p>This sets the electronic shutter as well as the ExDR (Extended Dynamic Range). The use of an electronic shutter function enables shooting with proper brightness, as more brightness results in higher shutter speed. The ExDR function allows even the shooting of a subject having different luminous flux density by composing a picture shot at 1/100 (1/120) sec. shutter speed with a picture shot by a high-speed shutter. ( ):TK-C1480U</p> <p><b>NORMAL:</b> This fixes the shutter speed to 1/50 (1/60). The ExDR does not function.</p> <p><b>MANUAL:</b> This sets the shutter speed by the item SHUTTER SPEED on the SHUTTER screen. The ExDR does not function. When SENSE UP is functioning, MANUAL cannot be selected. (Not displayed on MENU)</p> <p><b>AUTO:</b> This automatically switches the shutter speed according to brightness. The ExDR does not function. The item FAST LIMIT on the SHUTTER (ExDR) screen sets a maximum shutter speed value.</p> <p><b>M.ExDR:</b> This is used when shooting a subject with difference in a luminous flux density in the screen under a fixed illumination condition, and so on. During ExDR mode, the item M.ExDR.SPEED on the SHUTTER (ExDR) screen sets the composing high shutter speed. It is possible to set only when the items BLC and SENSE UP are OFF. What's more, the ExDR LEVEL sets the signal level of the composing high-speed shutter.</p> <p><b>A.ExDR:</b> This is used when the subjects having different luminous flux densities are continuously used night and day in the situation where both indoor and outdoor subjects are mixed in existence, and so forth. During ExDR mode, the composing shutter speed automatically varies according to the contrast of a subject. This is set when shooting the subject with changing brightness. This can be set only when the item BLC is OFF. What's more, the ExDR LEVEL sets the signal level of the composing high-speed shutter.</p> <p>— MEMO —</p> <ul style="list-style-type: none"> <li>• Do not set to A.ExDR when using a manual lens.</li> <li>• When M.ExDR mode or A.ExDr mode is used, the border between a bright part and a dark part can be coloured (cyan, orange, etc.), but this is not a malfunction.</li> </ul>	NORMAL
SHUTTER SPEED	<p>This sets a shutter speed when MANUAL is set. The AUTO, M. ExDR, A. ExDR set value is displayed as “- - -” and cannot be changed [Set values: 1/120 (1/100), 1/250, 1/500, 1/1000, 1/2000, 1/4000, and 1/10000] ( ):TK-C1480U</p>	1/120 (1/100)

\* When the SHUTTER (ExDR) item is set to NORMAL, the following items (SHUTTER SPEED, FAST LIMIT, ExDR LEVEL, and M.ExDR SPEED) cannot be changed.

# MENU SETTING

## ALC SETTINGS Screen (Continued)

Item	Functions and set values	Initial value
FAST LIMIT	This sets the fastest value of a shutter speed when AUTO is set. The MANUAL, M. ExDR, A. ExDR set value is displayed as “- -” and cannot be changed. The higher the shutter speed becomes, the more smear phenomenon is emphasized, which is peculiar to the CCD. [Set values: 1/1000, 1/2000, 1/4000, 1/10000, 1/20000, 1/40000, 1/100000]	1/100000
ExDR LEVEL	This sets the signal level of the composing high-speed shutter during ExDR mode. This is set according to the brightness of a subject. When using M.ExDR, be sure to set M.ExDR SPEED in advance. When the SHUTTER (ExDR) item is set to MANUAL or AUTO, “- -” appears, disabling setting. To give priority to the low-brightness parts of the subject... increase the value To give priority to the high-brightness parts of the subject... decrease the value [Set values: -5 to NORMAL to 5] — <b>MEMO</b> — • In the case of a subject with a large difference in the luminous flux density, sometimes images do not change even if ExDR LEVEL is varied. However, this occurrence is a peculiarity of the unit and is not a malfunction.	NORMAL
M.ExDR SPEED	This sets the composing high shutter speed when ExDR is set to M.ExDR. Set the shutter speed in order that a subject with a high luminous flux density (outdoor, etc.) may come out most clearly. This is displayed as “- -” during MANUAL, AUTO or A. ExDR and cannot be set. [Set values: 1/500, 1/1000, 1/2000, 1/4000, 1/10000, 1/20000]	1/4000
AGC MODE	This sets a maximum gain of the AGC (Automatic Gain Control). OFF: When the AGC function is not used. 10dB: When luminous energy is insufficient. 20dB: When luminous energy is extremely insufficient. SUPER: When brightness is insufficient even when it is set to 20dB. • If the gain is increased, the screen gets rough in a dark place. • If it is set to SUPER, it can sometimes consume operation time to cope with a drastic level change. • When the item “B&W” is set to “AUTO”, [SUPER] is displayed when the item “AGC MODE” is set to “SUPER”, and [20dB] is displayed for other settings. Increase the gain up to the value displayed.	20dB
LOLUX MODE	Used when brightness is low even when setting the AGC MODE. (Functions regardless of the AGC MODE setting.) OFF: LOLUX MODE is off. ON: LOLUX MODE is on (+ 6dB)	OFF
SENSE UP	This item makes up a sensitivity should be heightened automatically when a subject becomes dark. In case of the X32 AUTO, the sensitivity is automatically heightened up to 32 times continuously as compared with standard. As the sensitivity becomes higher, the shutter speed becomes lower, resulting in unnatural motion. If SHUTTER (ExDR) is set to MANUAL or the M.ExDR, “- -” will appear, disabling the SENSE UP function. [Set values: OFF, X2 AUTO, X4 AUTO, X8 AUTO, X16 AUTO, X32 AUTO] — <b>MEMO</b> — • When the magnification of SENSE UP is enhanced, the screen can become coarse or whitish, or whitish flaws can emerge sometimes, but this is not abnormal.	OFF

Item	Functions and set values	Initial value
<p>PRIORITY</p>	<p>This item sets the order in which the AGC and slow shutter speed decrease function when the object brightness becomes low.</p> <p>When the item AGC MODE or the item SENSE UP is set to OFF, “- - -” will appear, disabling any setting.</p> <p>MOTION: Priority is given to motion. This is suitable to a subject with quick motion, since the AGC (automatic gain control) functions with priority when the subject becomes dark.</p> <p>PICTURE: Priority is given to image. When the subject becomes dark, SENSE UP (sensitivity goes up) functions with priority, offering suitability that gives priority to image.</p>	<p>MOTION</p>
<p>BLC</p>	<p>Sets the backlight compensation function. Set when a bright light source, etc. is placed in the same direction as the subject.</p> <p>If the item SHUTTER (ExDR) is set to the M.ExDR or the A.ExDR, “- - -” will appear, and the BLC does not function.</p> <p>OFF: The backlight compensation function does not work.</p> <p>AREA 1 to AREA 4: When the SET button is pressed, the fixed light metering areas are displayed. Select one of the four types. (Indicated positions on the screen are rough guides. Execute required settings after checking and confirming the functions on actual images.)</p> <div data-bbox="322 954 797 1125" data-label="Diagram"> <p>The diagram illustrates five different light metering area configurations for the BLC function. Each configuration is shown as a square frame with a specific area highlighted in gray. Above each frame is the label 'Light metering area'. Below each frame is its corresponding label: OFF, AREA 1, AREA 2, AREA 3, and AREA 4.</p> </div> <p>EDIT 1 to EDIT 2: When the SET button is pressed, the user light metering areas are displayed. Select one of the two types.</p> <p> “BLC EDITTING Screen” on page 34.</p>	<p>OFF</p>

# MENU SETTING



## VIDEO ADJUST Screen

Adjustments are made on video signals.

Item	Functions and set values	Initial value
WHITE BALANCE	<p>Selects the white balance adjustment function. The white balance can be adjusted manually or automatically for light within the colour temperature range of 2500K to 8000K.</p> <ul style="list-style-type: none"> <li>• ATW: Auto-Tracking White Balance mode. This automatically adjusts the white balance.</li> <li>• AWC: Auto White Balance Controll mode. When the SET button is pressed, the adjustment screen appears. ( See page 35.)</li> </ul>	ATW
COLOUR LEVEL	<p>To adjust the colour level of the video signal.</p> <ul style="list-style-type: none"> <li>• To make colours lighter ... Decrease the value</li> <li>• To make colours darker ... Increase the value</li> </ul> <p>[Set values: -5 to NORMAL to 5]</p>	NORMAL
ENHANCE LEVEL	<p>To adjust the contour enhancing level of the video signal.</p> <ul style="list-style-type: none"> <li>• To make the picture quality harder ... Increase the value</li> <li>• To make the picture quality softer ... Decrease the value</li> </ul> <p>[Set values: -5 to NORMAL to 5]</p>	NORMAL
PEDESTAL LEVEL	<p>To adjust the pedestal level of the video signal.</p> <ul style="list-style-type: none"> <li>• To brighten picture ... Increase the value</li> <li>• To darken picture ... Decrease the value</li> </ul> <p>[Set values: -5 to NORMAL to 5]</p>	NORMAL
AUTO BLACK CTL	<p>This is set when it is difficult to view a dark part of the image even if gain is boosted by the AGC (automatic gain control).</p> <p>ON: When a black level of the image signal is low, a pedestal level that becomes the standard of black is automatically elevated, making it easier to view a dark part.</p> <p>OFF: AUTO BLACK does not function.</p> <p>— MEMO —</p> <ul style="list-style-type: none"> <li>• When PEDESTAL LEVEL is set to 5, no function can take place even if AUTO BLACK CTL is ON.</li> <li>• When AGC MODE is set to OFF, no function can take place even if AUTO BLACK CTL is ON.</li> </ul>	OFF

## MODE SELECT Screen

Titles, image reversion, etc., are set.

Item	Functions and set values	Initial value
CAMERA TITLE EDIT	Bring up the CAMERA TITLE, EDIT screen. (  Page 36)	—
REVERSE MODE	Settings are executed for image reversion. OFF: Image does not reverse. R-L: Left and right of the image are reversed. U-D: Up and down of the image are reversed. ALL: Up and down and left and right of the image are reversed.	OFF
ALM.TITLE SIZE	Set the size of the characters displayed in the case of alarms.  <div style="display: flex; justify-content: space-around; align-items: center;"> <div style="text-align: center;">  NORMAL         </div> <div style="text-align: center;">  DOUBLE         </div> </div>	DOUBLE
ALARM COLOUR	This sets the colour of an alarm title. [Set values: WHITE, YELLOW, CYAN, GREEN]	WHITE
D.ZOOM MAX	This function sets the maximum zoom ratio of the electronic zooming. [Set values: x1, x2, x4, x6, x8, x10]  — MEMO — <ul style="list-style-type: none"> <li>• The electronic zoom function can only be used by the communication command of exclusive controllers (RM-P2580, etc.).</li> <li>• Note Picture quality deteriorates under electronic zooming as it is accompanied by digital image processing.</li> <li>• When the electronic zoom magnification ratio is increased, there may be blurring in the upper center left of the screen. This is a characteristic of the main unit and is not a malfunction.</li> </ul>	x2

## MOTION DETECT Screen

Settings are executed about the motion detecting function that emits alarm signals when there exists any motion in the image. Alarm signals are output from the auxiliary terminals on the back.

Item	Functions and set values	Initial value
MODE	This sets ON/OFF of motion detecting function. OFF: Motion detecting function does not work. ON: Motion detecting function works.	OFF

# MENU SETTING

## MOTION DETECT Screen(Continued)

Item	Functions and set values	Initial value
LEVEL	<p>This sets the level that detects motion.            If the item MODE is set to OFF, “- - -” will appear, and settings cannot be changed.            To function with large signal level change...decrease the value            To function with small signal level change...increase the value            [Set values: -5 to NORMAL to 5]</p>	NORMAL
AREA EDIT	<p>This sets the range in which the motion detecting function works.            (☞ Page 37)</p>	-
ALARM TIME	<p>This sets the output time of the alarm signal output of AUX terminal as well as “ALARM” display on the screen when motion is detected.            If the item MODE is set to OFF, “- - -” will appear, and settings cannot be changed.            [Set values: OFF, 5s, 6s, 7s, 8s, 9s, 10s, 15s, 20s, 30s, 1min]</p> <p>— <b>MEMO</b> —</p> <p>When the MODE item is set to OFF, only the alarm signal of the AUX terminal is output, and “ALARM” is not displayed on the screen.</p>	10s
DEMONSTRATION	<p>This is used when checking and confirming the set motion detecting function. The detection area is shown in gray.            (☞ Page 37)</p>	-



## COMMUNICATION Screen

Settings are made for the control signal-connecting terminals on the back.  
If the setting is changed, be absolutely sure to switch on the power again.

Item	Functions and set values	Initial value
STYLE	This sets a communication system according to the system used. P TO P (Point to point) This is set when a remote control unit controls a camera. M.DROP (Multi-drop) This is set when a remote control unit controls a plural number of cameras.	P TO P
MACHINE ID	This is set when the STYLE item is set to M.DROP. This is the number that identifies individual cameras in a group. No proper function can be realized if an ID number is repeated within a system. A combined use with the RM-P2580 necessitates the setting together with the video input number of the RM-P2580. If the item STYLE is set to P TO P, “- - -” will appear, and settings cannot be changed. [Set values: 1 to 99]	- - -

## FACTORY SETTINGS Screen

Set values are returned to initial values.

Item	Functions and set values	Initial value
FACTORY SETTINGS	The values set on the menu are returned to initial values. CANCEL : No return to the initial value. CLEAR : Returns set values except titles to the (WITHOUT TITLE) initial value. CLEAR (ALL) : Returns all set values including titles to the initial value. Select respective set value and press the SET button. Then, “DATA CLEARED” will appear for about 3 seconds. Be sure not to switch off the power while the display is still on.  — <b>MEMO</b> — However, when making settings by means of transmitted commands, the contents of the COMMUNICATION menu do not return to the factory settings.	—

# MENU SETTING

## BLC EDITTING Screen

It is possible to set freely the light metering area for backlight compensation. The 2 screens of EDIT1 and EDIT2 can be set.

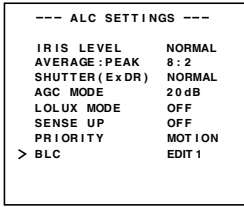

MENU button SET button

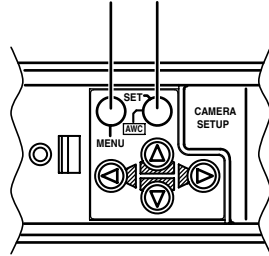

EDIT 1 screen

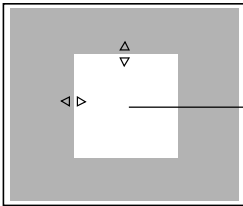

Light metering area

⇕ SET button

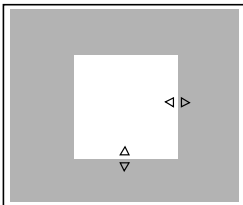

EDIT 2 screen

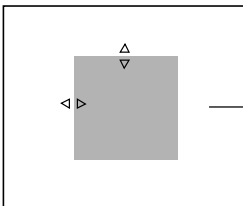

Light metering area

⇕ SET button

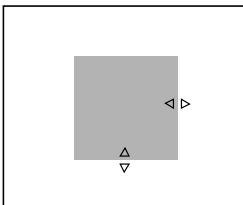

- 1.** Set the item BLC on the ALC SETTING screen to EDT1.
- 2.** Press the SET button.  
The EDIT1 screen is brought up.
- 3.** Set the upper side and left side of the metering area using the button.  
The sides having  $\Delta$   $\nabla$   $\triangleleft$   $\triangleright$  marks can be changed.
- 4.** Press the SET button.  
The changeable sides of the metering area move to the right side and base side.
- 5.** Set the base and right side of the metering area using the button.  
If the SET button is pressed once more, the two changeable sides of the metering area return to the top and left sides. (The EDIT2 screen can also be set likewise)
- 6.** Upon completion of setting, press the MENU button.  
The screen returns to ALC SETTING SCREEN.

\* To use the set metering area, set the item BLC to EDIT1 or EDIT2.

## Manual Adjustment of White Balance

When automatic adjustment of the white balance results in a “reddish screen”, etc., adjust the white balance manually.



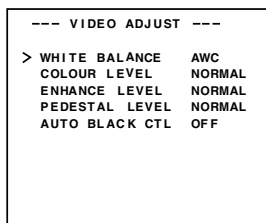
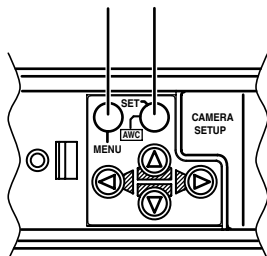

MENU button SET button

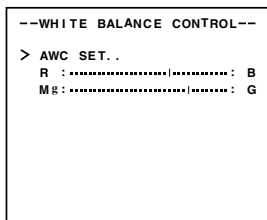

VIDEO ADJUST screen



WHITE BALANCE CONTROL screen

1. Set the WHITE BALANCE item on the VIDEO ADJUST screen to AWC and press the SET button.  
\* The WHITE BALANCE adjustment screen appears on the monitor.
2. Select the hue to be adjusted. (R/B or Mg/G)  
Press the  or  button.
3. Adjust the hue.  
Press the  or  button.  
\* The “i” indicator moves in accordance with the setting. When a setting is changed, the “+” mark appears at the original position.
4. Concluding manual white balance adjustment.  
Pushing the MENU button returns the screen to VIDEO ADJUST.

# MENU SETTING

## CAMERA TITLE Setting

Up to 24 characters can be selected as camera text for each camera. The set characters are displayed at the bottom of the screen.

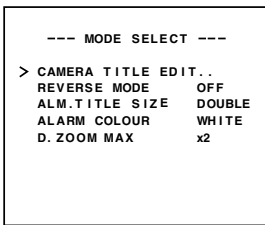
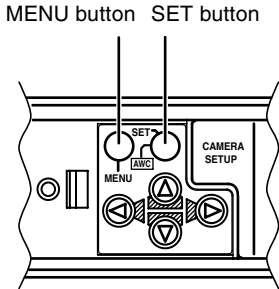

MODE SELECT screen

- 1.** Select the item CAMERA TITLE on the MODE SELECT screen, and push the SET button. Then, the CAMERA TITLE screen is brought up.
- 2.** Select the first character from the character area using buttons. The selected character is displayed flashing on and off.
- 3.** Push the SET button. The first character gets fixed and the blinking title input area moves to the second character.
- 4.** Repeat the above items 2 to 3. It is possible to use up to 24 characters to input the title.
- 5.** Push the MENU button. The screen returns to MODE SELECT.

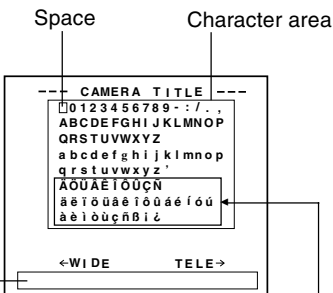

CAMERA TITLE screen

Title input area (The TK-C1480U does not display these characters.)

## Setting the MOTION DETECT Function

It is possible to set freely the area where MOTION DETECTING functions.

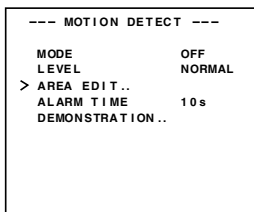

MOTION DETECT screen

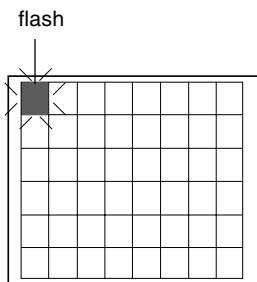

Setting screen

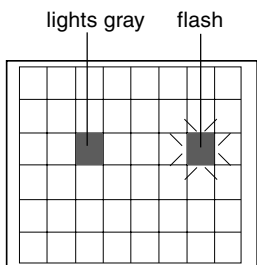

1. Select the item AREA EDIT on the MOTION DETECT screen.
2. Press the SET button.  
The setting screen is brought up.
3. Select the area not subject to detection using the button.  
The area flashing ON and OFF in black and white moves.
4. Press the SET button.  
The area not subject to detection is set, and it turns gray (lights up).  
To cancel the set area, press the SET button again.
5. Repeat items 3 and 4 above.
6. Upon completion of setting, press the MENU button.  
The screen returns to the MOTION DETECT menu.

### MEMO

Indicated positions on the screen are rough guides.

Be sure to check and conform the positions on the actual screen.

\* It is possible to check and confirm the set areas on the DEMONSTRATION screen.  
The detection area is shown in gray.

The motion detector is not a feature to prevent theft, fire, etc. Even if an accident should occur resulting in damage, we do not accept any liability.

# OTHERS

## Installing the ferrite core

To retain electromagnetic compatibility, use the ferrite cores provided when connecting to the lens or the power source.

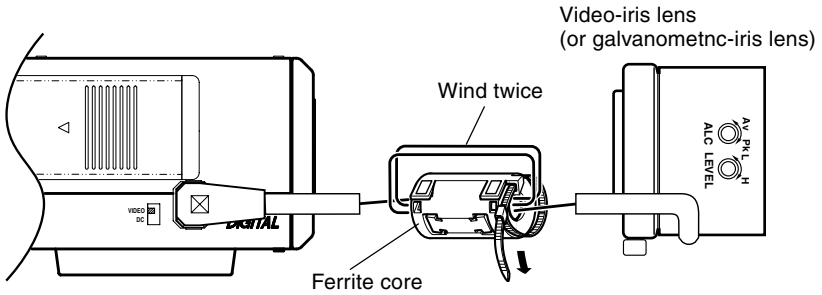

### Notes:

Install the ferrite cores within 50 mm of the camera-side connectors. (Fasten the ferrite core with the wire clamp provided.)

For lens connection: Pass the lens cable through the ferrite core twice and connect it to the camera.

## Specifications

### DIMENSIONS (Unit: mm)

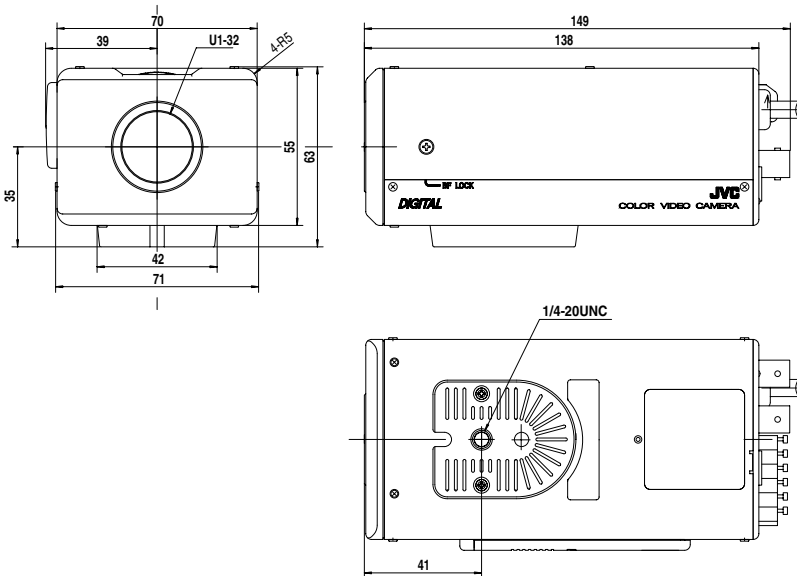

Image pickup device:	TK-C1480U 1/3 type IT CCD, 768 (H) × 494 (V) TK-C1480E and TK-C1481EG 1/2 type IT CCD, 752 (H) × 582 (V)
Synchronization method :	Internal, Line lock, Full Genlock
Scanning frequency:	TK-C1480U (H) 15.734 kHz, (V) 59.94 Hz TK-C1480E and TK-C1481EG (H) 15.625 kHz, (V) 50 Hz
Resolution:	480 TV lines (H)
VIDEO OUT:	Composite video signal 1 V (p-p), 75Ω (BNC)
Y/C OUT:	TK-C1480U (4-pin) Y: 1V(p-p), 75Ω C: 0.286V(p-p), 75Ω TK-C1480E and TK-C1481EG (4-pin) Y: 1V(p-p), 75Ω C: 0.3V(p-p), 75Ω
Video S/N ratio:	50 dB (AGC OFF)
Minimum required illumination:	0.8 lx (50%, F1.2, AGC 20 dB) 0.4 lx (25%, F1.2, AGC 20 dB) 0.025 lx (50%, F1.2, AGC 20 dB, SENSE UP × 32)
Communication:	RS-422A or RS-485 (switchable) 9600 bit/s
Lens mount:	C/CS mount
Power supply and power consumption:	TK-C1480U AC24V ~, 60 Hz, DC12V ≒ 5.5W TK-C1480E AC 24 V ~ 50 Hz/60 Hz, DC 12 V ≒ 500 mA TK-C1481EG AC220V to AC240V ~, 50 Hz/60 Hz, 75mA
Ambient temperature:	-10°C to 50°C (operation) 0°C to 40°C (recommended)
Mass:	TK-C1480U and TK-C1480E 600 g TK-C1481EG 835 g
Accessory:	TK-C1480U Instructions ..... 1 Ferrite core ..... 1 4P plug ..... 1 Warranty card ..... 1 Service Information card ..... 1 TK-C1480E and TK-C1481EG Instructions ..... 2 Ferrite core ..... 1 4P plug ..... 1

Design and specifications are subject to change without notice.



**JVC**<sup>®</sup> is a registered trademark owned by VICTOR COMPANY OF JAPAN, LTD.

**JVC**<sup>®</sup> is a registered trademark in Japan, the U.S.A., the U.K. and many other countries.

© 2001 VICTOR COMPANY OF JAPAN, LIMITED



Printed in Thailand  
SC961006H-007