

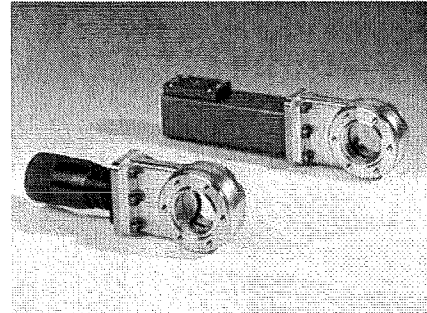

## Mini UHV gate valve with manual actuator with pneumatic actuator



This manual is valid for the valve ordering numbers:

01024/28/32/34- . E01/08

01024/28/32/34- . E11/21/31/41

01024/28/32/34- . E12/22/32/42

01024/28/32/34- . E14/24/34/44

The fabrication number is indicated on each product as per the label below (or similar):

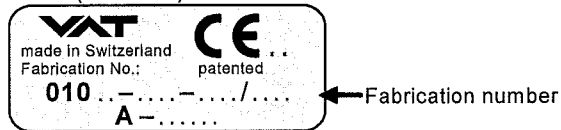

### Explanation of symbols:



Read declaration carefully before you start any other action!



Keep body parts and objects away from the valve opening!



Attention!



Hot surfaces; do not touch!



Product is in conformity with EC guidelines, if applicable!



Loaded springs and/or air cushions are potential hazards!



Disconnect electrical power and compressed air lines. Do not touch parts under voltage!



Wear gloves!



Read these «Installation, Operating & Maintenance Instructions» and the enclosed «General Safety Instructions» carefully before you start any other action!



**Installation, Operating, and Maintenance Instructions**  
**Series 01, DN 16 - 50 (5/8" - 2")**

---

**Imprint:**

**Manufacturer** VAT Vakuumventile AG, CH-9469 Haag, Switzerland

<b>Website</b>	<b>Phone</b>	<b>Fax</b>	<b>Email</b>
www.vatvalve.com	+41 81 771 61 61	+41 81 771 48 30	CH@vatvalve.com

**Publisher** VAT Vakuumventile AG, CH-9469 Haag, Switzerland

**Editor** VAT Vakuumventile AG, CH-9469 Haag, Switzerland

**Print** VAT Vakuumventile AG, CH-9469 Haag, Switzerland

**Copyright** © VAT Vakuumventile AG 2008

No part of these Instructions may be reproduced in any way (photocopies, microfilms or any other reproduction processes) nor may it be manipulated with electronic systems, duplicated or distributed without written permission from VAT. Offenders are liable to pay damages.

The original VAT firmware and updated state of the art versions of the VAT firmware are intended for use with VAT products. The VAT firmware contains a limited, time unlimited user license. The VAT firmware may not be used for purposes other than those intended nor is it permitted to make copies of the VAT firmware. In particular, it is strictly forbidden to give copies of the VAT firmware to other people.

The use of trade names, brand names, trademarks, etc. in these Instructions does not entitle third parties to consider these names to be unprotected and to use them freely. This is in accordance with the meaning of the laws and acts covering brand names and trademarks.

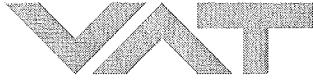

**Contents:**

1	Use of product .....	4
1.1	Technical data .....	4
2	Installation .....	4
2.1	Unpacking .....	4
2.2	Installation into the system .....	4
2.3	Admissible forces .....	5
2.4	Connections .....	5
2.4.1	Compressed air connection .....	5
2.4.2	Compressed air connection: Solenoid separate, without solenoid .....	5
2.4.3	Electrical connection .....	6
3	Operation .....	7
3.1	Normal operation .....	7
3.2	Operation of manual actuator .....	7
3.3	Operation under increased temperature .....	7
3.4	Compressed air failure .....	7
3.5	Power failure .....	7
3.6	Emergency operation at power failure .....	8
4	Trouble shooting .....	9
4.1	Global leak at bonnet seal after heating the valve! .....	9
5	Maintenance & repairs .....	9
5.1	Replacement of actuator/gate assembly .....	10
5.2	Replacement of gate .....	11
5.3	Replacement of position indicator .....	12
6	Drawing .....	13
7	Spare parts .....	14
8	Warranty .....	15



## 1 Use of product

Use product for clean and dry indoor vacuum applications under the conditions indicated in chapter «Technical data» only! Other applications are only allowed with the written permission of VAT.

### 1.1 Technical data

Pressure range	1 x 10 <sup>-10</sup> mbar to 2 bar (abs)
Differential pressure on the gate	≤ 2 bar in either direction
Differential pressure at opening	≤ 30 mbar
Admissible temperature: Valve	≤ 250°C open, 200°C closed
Manual actuator	≤ 250°C
Pneumatic actuator	≤ 200°C
Position indicator	≤ 80°C
Solenoid	≤ 50°C
Position indicator: Contact rating	5 A / 250 V AC, 3 A / 50 V DC
Solenoid	see tag on solenoid

**The temperatures specified in the technical data are only admissible if the valve is in open or closed position. Operation of the valve during the bakeout cycle is prohibited!**

Further data according to VAT catalogue

## 2 Installation

### 2.1 Unpacking

Make sure, that the delivered components are according the order.  
Visually check the quality of the components.  
If something of the delivery is not as expected please immediately contact VAT.

Notice:

Please do not throw away the original packaging. Packaging may be useful in a case of service to return the components to VAT.

### 2.2 Installation into the system

The valve seat side is indicated by the symbol "∇" on the connection flange.



### 2.3 Admissible forces

Tighten mounting screws of the flanges uniformly in crosswise order. Observe the maximum torque of 9 Nm / 6.5 lbf · ft for CF flanges

Forces from evacuating the system, from the weight of other components, and from baking can lead to deformation of the valve body and to malfunction of the valve. The stress has to be relieved by suitable means, e.g. bellows sections. The following forces are admissible:

Axial tensile or compressive force «FA»: 500 N / 112 lbf  
Bending moment «M»: 30 Nm / 22 lbf · ft

If a combination of both forces («FA» and «M») occurs, the values mentioned above are invalid. Please contact VAT for more information.

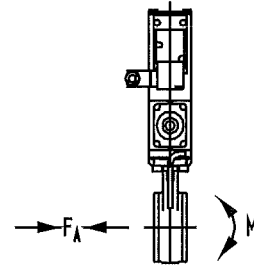

### 2.4 Connections

#### 2.4.1 Compressed air connection



- Connect compressed air only if
  - valve has been installed into the vacuum system
  - moving parts cannot be touched

With solenoid: Connect compressed air to **IN** (internal thread R 1/8", 1/8" NPT for USA)

Without solenoid: Connect compressed air to **OPEN** and **CLOSE** (internal thread M5)

Compressed air pressure (min. - max. overpressure): 5.0 - 7 bar / 72.5 - 100 psig

Use only clean, dry or slightly oiled air!

#### 2.4.2 Compressed air connection: Solenoid separate, without solenoid

Ordering No. 010 . . . E12/22

Pneumatic actuator: single acting with opening spring (NO)  
3/2-way valve

Compressed air connection: Internal thread R1/8" (1/8" NPT for USA)

Compressed air to connection <2>: valve closes

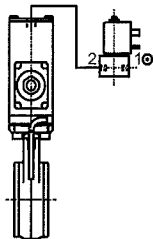

Ordering No. 010 . . . E11/21

Pneumatic actuator: single acting with closing spring (NC)  
3/2-way valve

Compressed air connection: Internal thread R1/8" (1/8" NPT for USA)

Compressed air to connection <2>: valve opens

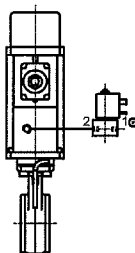

Ordering No. 010 . . . E14/24

Pneumatic actuator: double acting 4/2-way valve

Compressed air connection: Internal thread 1/8"

Compressed air to connection <A>: valve opens

Compressed air to connection <B>: valve closes

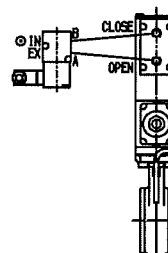



**2.4.3 Electrical connection**



Do not touch any electrically charged parts!



Connect electrical power only if  
 - valve has been installed into the vacuum system  
 - moving parts cannot be touched

Verify that mains voltage matches voltage stated on the solenoid! Sockets for position indicator and solenoid are supplied with the valve.

Wire solenoid and position indicator according to the following diagrams:

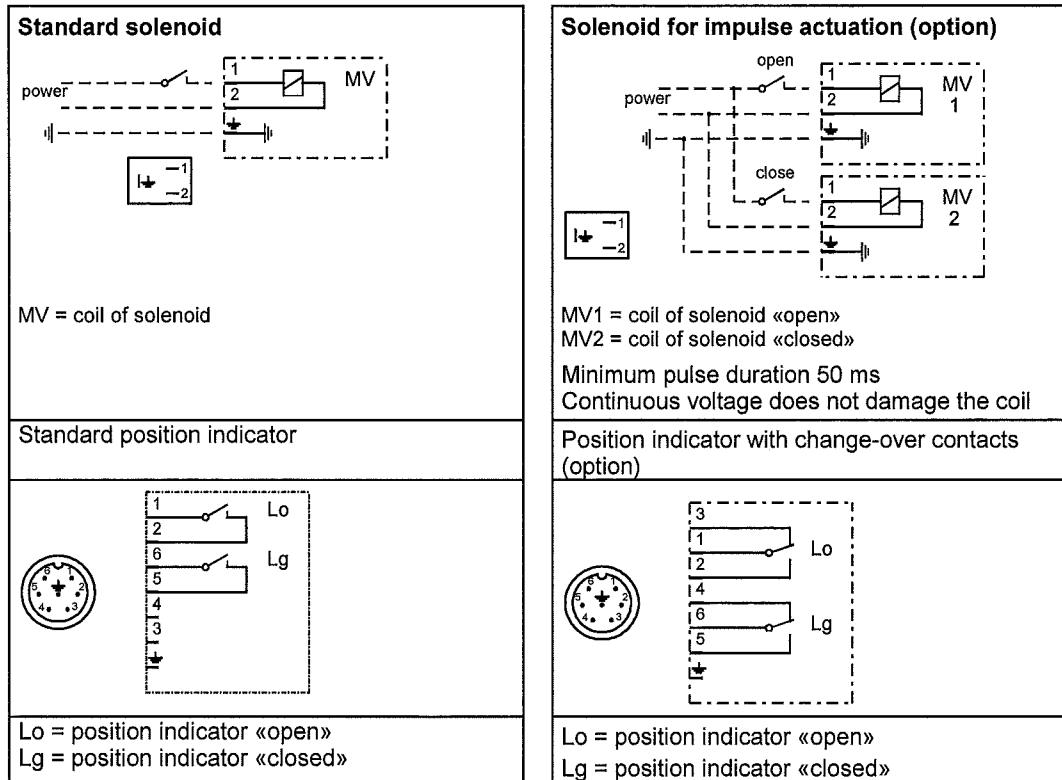



### 3 Operation

#### 3.1 Normal operation

01024/28/32/34- . E01/08	Valve is opened and closed manually.
01024/28/32/34- . E11/21/31/41	Valve is opened by compressed air and closed by a spring.
01024/28/32/34- . E12/22/32/42	Valve is opened by a spring and closed by compressed air.
01024/28/32/34- . E14/24/34/44	Valve is opened and closed by compressed air.

#### 3.2 Operation of manual actuator

Do not exceed the maximum torque of 6 Nm.

This torque is fairly reached by tightening the manual actuator by one hand.

A higher torque may damage the gate seal.



#### 3.3 Operation under increased temperature

See «Technical data»!

The temperatures specified in the technical data are only admissible if the valve is in open or closed position. Operation of the valve during the bakeout cycle is prohibited.

#### 3.4 Compressed air failure

Pneumatic actuator: single acting with opening spring	valve opens
single acting with closing spring	valve closes
Double acting: valve closed	valve remains closed and leaktight
valve open	valve position is undefined, depending on mounting position

#### 3.5 Power failure

Pneumatic actuator: single acting with opening spring	valve opens
single acting with closing spring	valve closes
double acting (standard solenoid):	valve closes
double acting (solenoid for impulse actuation - option):	valve remains in its position, but a started movement will be completed



### 3.6 Emergency operation at power failure

In case of a power failure, the valve can be actuated manually if compressed air is available:

Ordering No. 010 . . . E32/42

Pneumatic actuator:  
single acting with opening spring (NO)

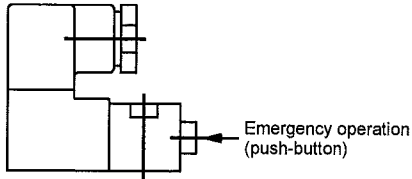

Press push-button: valve closes  
Release push-button: valve opens

Ordering No. 010 . . . E31/41

Pneumatic actuator:  
single acting with closing spring (NC)

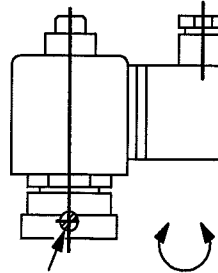

Emergency operation (slotted screw)

Turn in clockwise order: valve opens  
Turn in counter-clockwise order: valve closes

**Attention!**

Remote operation is only possible if the emergency operation (slotted screw) is turned counter-clockwise to its stop.

Ordering No. 010 . . . E34/44

Pneumatic actuator: double acting

Standard solenoid

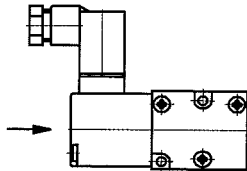

Press key-button: valve opens  
Release key-button: valve closes

Solenoid for impulse actuation (option)

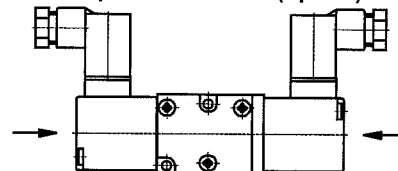

Press push-button on the left: valve opens  
Press push-button on the right: valve closes





## 4 Trouble shooting

Valve does not close/open:	Power available? Compressed air available? Solenoid defective? Check voltage! Check air pressure!
Leak at gate:	Clean valve seat and gate! Replace gate if damaged! Correct air pressure?
Leak at body:	Flanges leaktight? Replace bonnet seal!

### 4.1 Global leak at bonnet seal after heating the valve!

Due to a possible settlement of screw and VATSEAL it could happen that after a heat up and cool down procedure the bonnet seal becomes slight leaky. In this case please check the torque (see below) of bonnet screw (see page 13 item 15) and tighten the screws if necessary with a torque wrench.

Remark:

Do tighten screws crosswise!

Necessary torque of screws is for DN16 -DN50; 10 Nm / 7.4 lbf · ft.

If you need any further information, please contact one of our service centers. You can find the addresses on our website:  
<http://www.vat.ch>

## 5 Maintenance & repairs

Under clean operating conditions, the valve does not require any maintenance during the specified cycle life. Contamination from the process may influence the function and requires more frequent maintenance.

Before carrying out any maintenance or repairs, please contact VAT. It has to be individually decided whether the maintenance/repair can be performed by the customer or has to be carried out by VAT. The fabrication number on the valve

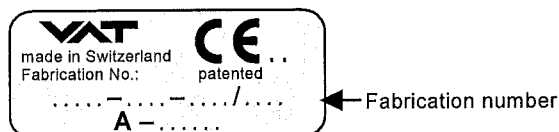

has always to be specified.

All supplies (e. g. compressed air, electrical power) must be disconnected for removal/installation of the valve from/into the system and for maintenance work.



Even with disconnected supply, loaded springs and/or air cushions in cylinders can be potential hazards.



Keep fingers and objects away from the valve opening!

Products returned to VAT must be free of harmful substances such as e.g. toxic, caustic or microbiological ones. If products are radioactively contaminated, fill in the VAT form «Contamination and Radiation Report» and send it with the product. The form is available at VAT. The maximum values indicated in the form must not be exceeded.

## 5.1 Replacement of actuator/gate assembly

The figures in brackets refer to the drawing on page 13

1. Vent vacuum chambers on either side of valve
2. Open valve
3. Disconnect compressed air
4. Disconnect electrical power
5. Disconnect compressed air line and plug (4) from solenoid and plug (2) from position indicator
6. Remove screws (15) from bonnet
7. Withdraw actuator/gate assembly carefully from body and put it on a clean place
8. Check and clean sealing surfaces of bonnet and valve seat
9. Put new bonnet seal «VATSEAL» (7) on body or bonnet (depending on mounting position)  
**Attention:** Bordering of 2 bore holes must be on the body side!
10. Insert actuator/gate assembly carefully. At first, insert two screws (15) at both centering holes (bordering) of the bonnet seal «VATSEAL» (7) and tighten them slightly only. Afterwards, tighten all screws (15) uniformly in crosswise order (diagonal), in 2 or 3 steps, by means of the supplied hexagon pin spanner.  
**Notice!** A suitable torque wrench with the appropriate hexagonal insert to tighten the screws (tightening torque: 10 Nm) is available from VAT (item 10, 11, 12)
11. Connect plug (2) to position indicator
12. Connect plug (4) to solenoid
13. Connect compressed air
14. Perform function and leak test
15. Valve is ready for operation

## 5.2 Replacement of gate

The figures in brackets refer to the drawing on page 13

1. Press out pin (9) by means of tool (8)
2. Take new gate (6) and press in new pin (supplied with new gate) by using the same tool

**ATTENTION:** Inspect position of pin in the opening. The pin must be flush with the valve shaft!

The opening of the pin has to point into the direction of the gate or the actuator. An incorrect located pin may result in a damage of the valve.

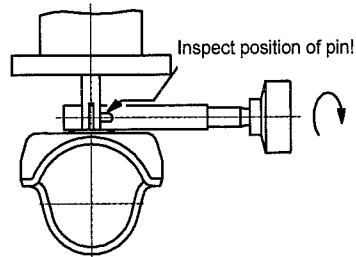

Correct assembly

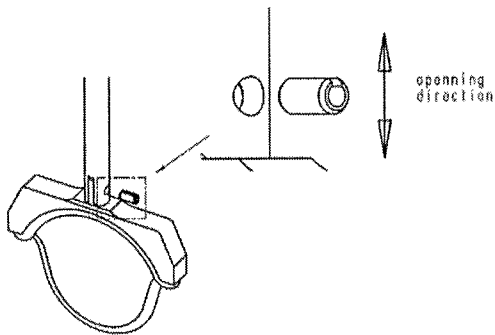

Wrong assembly

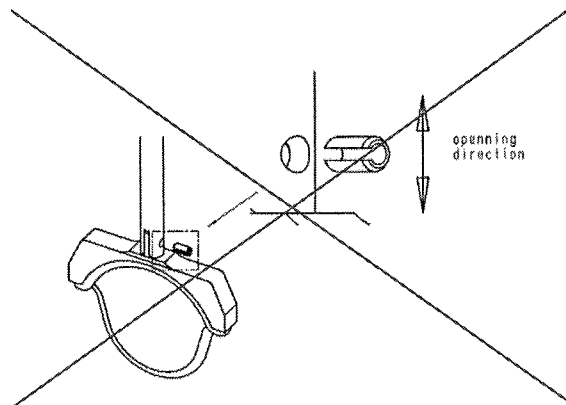

### 5.3 Replacement of position indicator

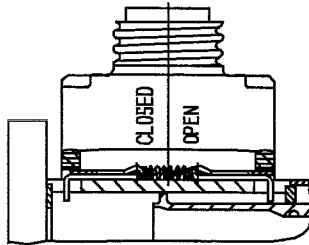

Fig 1  
 Before mounting the new position indicator, move the gate to the **intermediate position**. Then attach new position indicator.

Gate valve with double acting pneumatic actuator:  
 Move gate to the intermediate position by compressed air.

Gate valve with single acting pneumatic cylinder and closing spring:  
 Move gate to the intermediate position by compressed air and keep up an air pressure of approx. 2.5 bar ( 35 psig) in order to maintain the intermediate position.

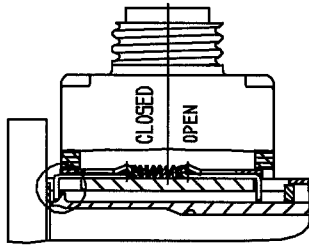

Fig 2  
 Correct mounting of position indicator, i.e. valve piston is not blocked by the position indicator actuator.  
 (⇒ see circle marking)

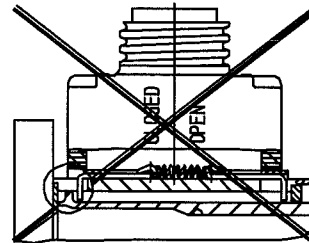
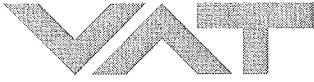
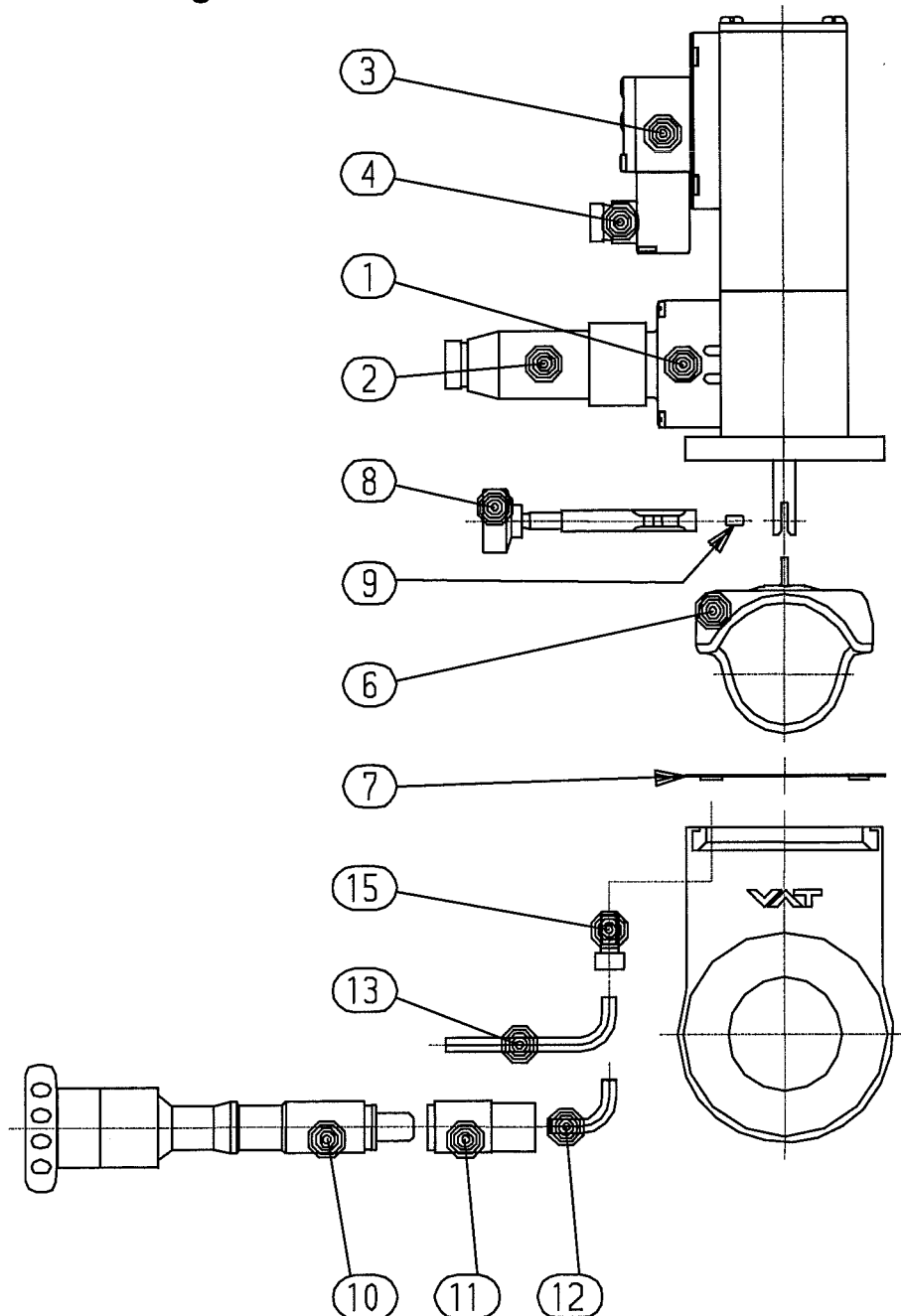

Fig 3  
 Wrong mounting of position indicator, i.e. valve piston is blocked by the position indicator actuator (⇒ see circle marking).

In this case, valve cannot be opened.



## 6 Drawing





## 7 Spare parts

The item numbers refer to the drawing on page 13.

The ordering numbers are valid for standard valves without options.

Item	Description	Part No.
	Seal kit, consisting of gate (6) with pin (9) and bonnet seal (7)	91984-R1
6/9	Gate with pin	91983-R1
7	Bonnet seal	65209-01
1	Position indicator: Ordering No. 010 . . . . E22/42 (valve with closing spring - NC) Ordering No. 010 . . . . E21/41 (valve with opening spring - NO) Ordering No. 010 . . . . E24/44 (double acting)	69250-R1 69249-R1 69250-R1
8	Special tool to remove/insert pin	69842-R1
3	Standard solenoid with coil Ordering No. 010 . . . . E31/41 (valve with closing spring - NC) Ordering No. 010 . . . . E32/42 (valve with opening spring - NO) Ordering No. 010 . . . . E34/44 (double acting)	N-7501-306* N-7553-000* N-7557-018*
3	Solenoid for impulse actuation with coil only ordering No. 010 . . . . E34/44	N-7557-021*

..... \*) **Specify voltage!**  
(e. g. N-7557-018-**220V 50Hz**)



## 8 Warranty

Each product sold by VAT Vakuumventile AG (VAT) is warranted to be free from the manufacturing defects that adversely affect the normal functioning thereof during the warranty period stated in VAT's «Terms of Sale» immediately following delivery thereof by VAT, provided that the same is properly operated under conditions of normal use and that regular, periodic maintenance and service is performed or replacements made, in accordance with the instructions provided by VAT. The foregoing warranty shall not apply to any product or component that has been repaired or altered by anyone other than an authorized VAT representative or that has been subject to improper installation or abuse, misuse, negligence or accident. VAT shall not be liable for any damage, loss, or expense, whether consequential, special, incidental, direct or otherwise, caused by, arising out of or connected with the manufacture, delivery (including any delay in or failure to deliver), packaging, storage or use of any product sold or delivered by VAT shall fail to conform to the foregoing warranty or to the description thereof contained herein, the purchaser thereof, as its exclusive remedy, shall upon prompt notice to VAT of any such defect or failure and upon the return of the product, part or component in question to VAT at its factory, with transportation charges prepaid, and upon VAT's inspection confirming the existence of any defect inconsistent with said warranty or any such failure, be entitled to have such defect or failure cured at VAT's factory and at no charge therefor, by replacement or repair of said product, as VAT may elect. VAT MAKES NO WARRANTY OR REPRESENTATION OF ANY KIND, EXPRESS OR IMPLIED, (INCLUDING NO WARRANTY OR MERCHANTABILITY), EXCEPT FOR THE FOREGOING WARRANTY AND THE WARRANTY THAT EACH PRODUCT SHALL CONFORM TO THE DESCRIPTION THEREOF CONTAINED HEREIN, and no warranty shall be implied by law.

Furthermore, the «Terms of sale» at the back of the price list are applicable.

