

Operating Instructions

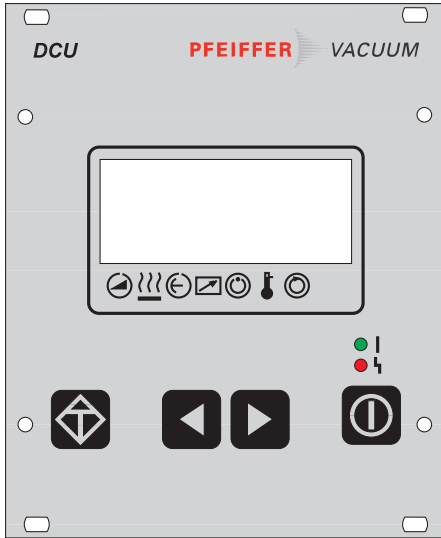

Display And Operating Unit

DCU 002

**DCU 110, DCU 180,
DCU 310, DCU 400**

Index

	Page
1. Safety Instructions	3
2. Understanding The Control And Operating Unit DCU	4
2.1. For Your Orientation	4
2.2. Product Description	4
Scope of Delivery	4
Mechanical Design	4
Connection Options	5
Proper Use	5
Improper Use	5
2.3. Front Panel	5
2.4. Rear Panel	6
3. Installation	7
3.1. Preparations For Installation	7
3.2. Rack Fitting	7
3.3. Connecting Diagram	7
3.4. Making The Connections	8
4. Operations	8
4.1. Short Overview, Operating	8
4.2. General	9
4.3. Switching On The DCU	9
Self-Testing	9
4.4. Functions Of The Keys	10
4.5. LC-Display	10
4.6. Symbol Definitions	12
4.7. LED Display	13
4.8. The Serial Interface	13
5. Pressure Measurement	13
5.1. Parameter List	14
6. Error-/Warning Codes	14
6.1. General	14
6.2. Errors and Warnings	15
7. Maintenance and Service	15
8. Technical Data	16
8.1. Data List	16
8.2. Dimensions	16
9. Supplementary Informations	17
Manufacturer's Declaration	Appendix 1

1. Safety Instructions

- ☞ Read and follow all instructions in this manual.
- ☞ Inform yourself regarding
 - Dangers which can arise from the unit;
 - Dangers which can arise from the system;
- ☞ Follow the safety and accident prevention instructions.
- ☞ Check regularly that all safety and protection requirements are being observed.
- ☞ When installing the DCU, take account of the ambient conditions.

The protection type is IP 20. The units DCU are protected against the ingress of foreign bodies $\leq \varnothing 12$ mm. Since water protection is not provided, the unit should be mounted in a suitable housing (see Section 3. "Installation").
- ☞ Do not carry out any unauthorised modifications or alterations to the DCU.
- ☞ Do not open the housing cover when the unit is connected to the mains nor during pumping operations.
- ☞ Take account of the prescribed mains voltage values when connecting units DCU 110 to DCU 400.
- ☞ When shipping, please note the instructions in Section 7.

Pictogram definitions:



There is danger of an electric shock if the contacts are touched.



There is danger of personal injury.



There is danger of damage to the unit or to the system.

2. Understanding The Display and Operating Unit DCU

2.1. For Your Orientation

Symbols used

The following symbols will be used in the illustrations throughout the manual:



Electrical connection

Abbreviations used

TMP = Turbomolecular Pump
DCU = Display and Operating Unit
TC = Electronic Drive Unit
TPS = Mains Power Unit

Position numbers

The same accessory parts have the same position numbers in all illustrations.

Operation instruction in the text

➔ Here you must do something.

2.2. Product Description

The Display Control Unit DCU is an operating unit for PFEIFFER drive units. It enables control over all the main parameters of the unit. Additionally, the connection of a vacuum gauge is possible.

DCU 002 = Basic unit without mains power unit
DCU 110/180/310/400 = Unit with mains power unit.

Scope of Delivery

- Display Control Unit DCU
- Connecting cable DCU - TC (3m)
- 4 mounting screws

Mechanical Design

The DCU is fitted in a housing suitable for mounting in a 19"/3HE rack.

Connection Options

The DCU provides the following connection options:

- Electronic drive unit for turbopump ("DC out")
- Pressure gauge (X3).
- Serial interface RS-485.

The units DCU 002, DCU 110 - DCU 400 have been tested and passed by the authorities in accordance with EN 61010/VDE 0411 "Safety Equipment For Electrical Units".

Proper Use

- The display and operating unit DCU may only be used to control PFEIFFER Electronic Drive Units and their peripheral units.
- Instructions concerning installation, start-up, operating and maintenance must be observed.

Improper Use

Improper is:

- Uses not covered above, especially:
 - Connection to pumps and units which is not permitted in their operating instructions.
 - Connection to units which contain touchable and voltage carrying parts.
 - Applications with this unit in radioactive areas.

Improper use will cause any rights regarding liability and guarantees to be forfeited.

2.3 Front panel

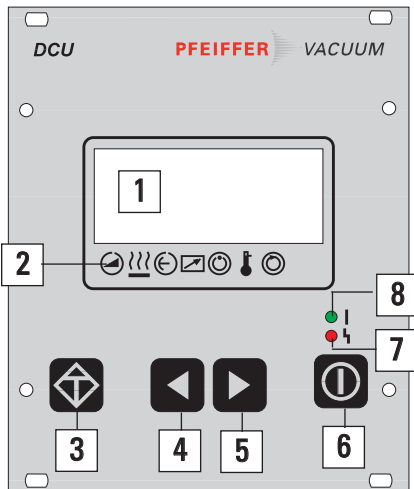

The front panel contains all the operating and display elements.

- 1 LCD display, illuminated
- 2 Status display (symbol definitions see chapter 4.6.)
- 3 "Error acknowledgement" key
- 4 Key "Left"
- 5 Key "Right"
- 6 "Pumping Station ON/OFF" key
- 7 Red illuminating diode for error status
- 8 Green illuminating diode for operating status

2.4 Rear Panel

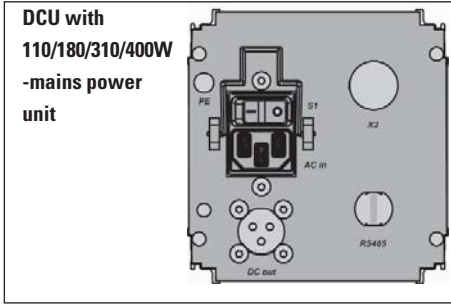

- S1 Mains switch
- AC in Mains connection 115/230 V AC
- DC out Output for voltage supply, electronic drive unit
- X3 Pressure gauge connection
- RS-485 Communication with electronic drive unit

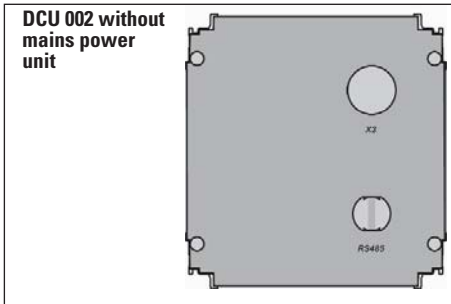

- X3 Pressure gauge connection
- RS-485 Communication with electronic drive unit

3. Installation

3.1. Preparations For Installation



Unauthorised modifications or alterations to the Display Control Unit are not allowed.

The unit must be fitted in a housing taking account of the ambient conditions (see section "Technical Data").

➔ Disconnect mains power plug before installation work.

Installation location: Protected against the weather.

The following is applicable for open buildings and operations rooms which are not fully air conditioned:

- Temperature:** +5°C - +50°C.
- Relative humidity:** 5 - 85%, non-condensing.
- Air pressure:** 86 kPa - 106 kPa

3.2. Rack Fitting

The units DCU 002, DCU 110 - DCU 400 are designed to be fitted into a 19"/3HE rack with guide rails.

- ➔ For installation secure the front panel to the rack using four fixing screws.
- ➔ Ensure free convection. The minimum distance to the upper and lower ventilation slits must be ≥ 50 mm.
- ➔ Please install in vertical direction.

The ambient temperature in the rack housing must not exceed 50°C.
Depending on the version, various connections are provided on the DCU.

3.3. Connecting Diagram

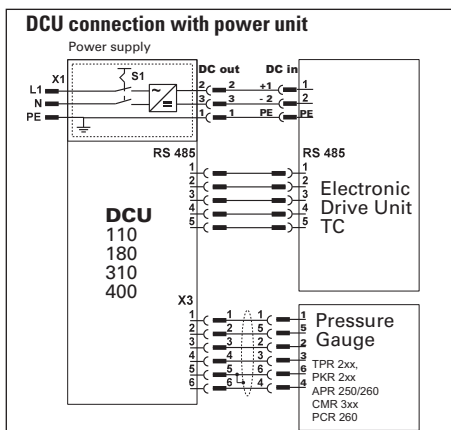
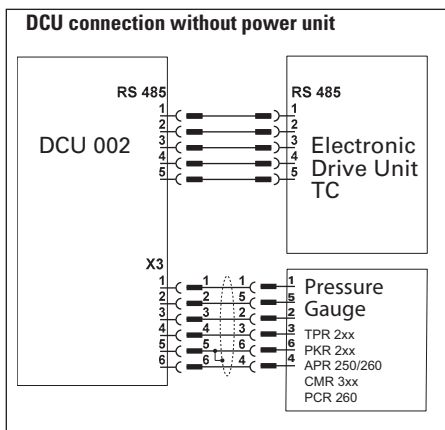

3.4. Making The Connections

- The units DCU 110 - DCU 400 have been designated protection class 1 and must always be connected with the earthed conductor (PE) via the mains cable.
- ➔ Mains connection must be made in accordance with the local regulations.
- ➔ Make the connection "DC out" - Electronic Drive Unit in accordance with the connecting diagram, section 3.3.



If using the DCU with TC 400 electronic drive unit, please disconnect the remote plug before connection.

If using the TC 110 electronic drive unit, switch off "Remote Priority" (S1/S2=OFF) before connecting.

- ➔ Make the connection pressure gauge to X3 as required.
- > **Please note:** if connecting a pressure gauge PCR 260, "TPR" is shown at the display.
- ➔ Make the connection RS-485/DCU-RS-485/Electronic Drive Unit via the delivered 5 pole cable.

The DCU 002 is re-supplied with its operating voltage via the Serial Interface RS-485 cable from the Electronic Drive Unit. As soon as this unit is switched on, the DCU is supplied with voltage.

Mains voltage (DCU 110...400)



115/230V AC (-20/+15%), 50/60 Hz

4. Operations

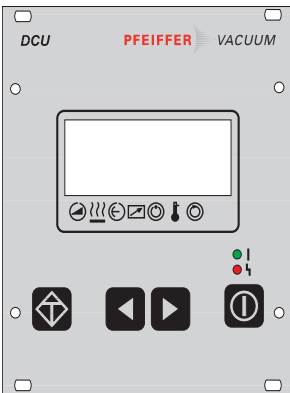
4.1. Short Overview, Operating





Selecting the parameters



- ➔ Select the parameter numbers with the keys  (back) or  (forward) (keeping the key depressed enables rapid scrolling).

Setting parameters

- ➔ Select a parameter.

- ➔ Depress keys  and  simultaneously.

-> The arrow (--->) appears in the second line from the top.

- ➔ Reduce or increase the values with the key  or  respectively.

- ➔ Depress key  and  simultaneously.

-> The arrow (--->) disappears.

-> The parameter is set.

4.2. General

All function relevant aspects of the pump electronics are illustrated in the form of parameters. Each parameter has a number and a designation (for example, "720: Vent frequ").

The value of the parameter is always readable, in some cases also modifiable via the keyboard.

4.3. Switching On The Control Unit

➔ Make the connection to the Serial Interface RS-485.

DCU 002:

➔ Switch on the external supply of the Electronic Drive Unit (for example TPS 110-400).

DCU 110/180/310/400:

➔ Switch on the DCU by the switch S1 on the rear side.

➔ In the event of an error message: depress: .

Self-Testing

After switching on, the DCU performs a self-test and also a test on the connected turbo electronics. Run time of the self-test: approx. 20s. During the test a bar appears in the display in line 4 and this shows the progress of this procedure.

- **Display test:** All signs in the LC display are shown for a short time in black.
- **LED test:** During the whole testing process the red and the green LEDs illuminate.
- **DCU test:** The DCU hardware is tested.
- **Connection to the turbo electronics test:** The correct connection to the turbo electronics and their identity are examined.
- **Parameter test:** Information regarding the parameters is loaded.
- **Identification of the connected components:** The designation of the drive unit is displayed.

Providing there are no errors the DCU is now ready to operate.

4.4. Functions Of The Keys

The four keys on the front panel have the following functions:

Key	Application/Example		Explanation
			Reset (error acknowledgement). Acknowledges errors (red LED illuminates)
	—>	↶309: Act rotspd ↶310: TMP I-Mot ↷871 Hz ↷ 872 Hz	Scroll back parameters Scrolls back a parameter Reduce a value (with arrow “—>”)
		—>	↷310: TMP I-Mot ↷311: TMP Op hrs 871 Hz ↶ 872 Hz ↶
		001: Heating off	Alters a value (⇔ data editing mode) Access to a displayed value, if possible (arrow “—>” appears)
	simultaneously	—>	001: Heating off ✓
	010: Pump stat. on ⇔ off		Pumping Station ON/OFF Switches the pumping station ON and OFF, equivalent to parameter 010: “Pump stat.”

4.5. LC-Display

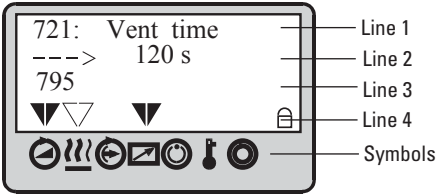

The functions are displayed via an illuminated four line LC display. A special function is assigned to each line:

- **Line 1:** Number and name of the selected parameter (for example 721: >>Vent time<<).
- **Line 2:** Relating value. If an arrow (--->) is displayed, the displayed value can be altered.
- **Line 3:** Two functions

Function 1: Messages relating to operations and operating are displayed. (see table “Operating Messages” in the operating instruction “Pumping Operations with DCU” and “Error Codes”, section 5).

Function 2: An optional second parameter in the form of >>Parameter number<< : >>value<< is displayed. The function of this line enables setting via parameter **[P:795]** >>Servicelin<< at line 1. With >>Servicelin<< all parameters can be displayed. Error messages are displayed independent of the selected function.

- **Line 4:** Arrows which points to the underlying symbol. This restores the unit status.







Please note:

Prolonged depressing of the key  or  enables rapid scrolling and/or alterations to the data.

The data mode (arrow “--->” is displayed) is automatically relinquished, without taking over the values to be altered, under the following conditions:

- No settings or key depressing for longer than 10 seconds.
- The occurrence of an error.
- The key  has been depressed.

4.6. Symbol Definitions

	Symbol	Arrow	Explanation
	Pump	–	No
	accelerates	▼	yes
	Pre-selection	–	No pre-selection
	heating	▽	Pre-selection heating, but switchpoint not attained
		▼	Heating ON, switchpoint attained
	Stand-by	–	Off
		▼	On
	Unit under remote control	–	No
		▼	Yes
	Switchpoint attained	–	No
		▼	Yes
	Excess-temperature	–	No excess temperatures
		▼	Excess temperature pump
		▽	Excess temperature pump elektronik
		▼	Excess temperature pump and pump elektronik
	Final rotation speed attained	–	No
		▼	Yes

4.7. LED Display

The red LED (error status) and green LED (operations status) on the front panel can take on the following conditions:

Red LED

Illuminates: Collective error messages
Flashes: Warning

Green LED

Illuminates: Mains power unit OK, pumping station ON
Flashes: Mains power unit OK, pumping station OFF
Blinks: Mains power failure

4.8. Serial Interface

The serial Interface RS-485 is only used for connecting the pump controller at the vacuum pump. The description of the interface protocol you can find in the operating instruction of the corresponding electronic drive unit.

5. Pressure Measurement

With the use of a high vacuum pressure gauge the pressure in the vacuum chamber is shown at the DCU display.



Basically an exactly pressure measurement is not possible by the DCU. This is especially indicated at linear working gauges in the lower pressure range. In case of doubt an intended measuring unit should be used.

Requesting the type of pressure gauge

- ➔ Select «**794 : Param set**» and set to «**1**».
- ➔ Select «**738 : gauge type**».
- ➔ Read off the pressure gauge type.

Some pressure gauges can only be recognized as a group (e.g. ACR 261-ACR 263) and have to be set manually.

Requesting the actual pressure value

- ➔ Select «**794 : Param set**» and set to «**1**».
- ➔ Select «**340 : Pressure**».
- ➔ Read off the pressure value in mbar.

The following can be displayed, depending on the pressure gauge type:

Display (Example)	Appears when
«---- mbar»	no pressure gauge is connected
«<5E-4mbar»	measuring range is non-attained (depending on the pressure gauge in use)
«>1E3mbar»	measuring range is exceeded (depending on the pressure gauge in use)
«6.3E-9mbar»	valid pressure measurement range
«idfam mbar»	pressure gauge type not yet identified
«TPR250»	pressure gauge TPR 250 connected
«ACR..?»	pressure gauge ACR 261, ACR 262 oder ACR 263 connected but not yet selected (in this case the display «idfam» [P:340] is shown)
«Error!»	error in the pressure gauge

5.1. Parameter List

The following parameters can be displayed or adjusted at the DCU:

#	Display	Name, Description	min	max	preset	RS-485 ¹⁾
340	Pressure	Actual pressure value [mbar]	1E-10	1E3	-	R
350	Ctr Name	Unit type operating and display unit	-	-	-	R
351	Ctr Softw	Software version Display and Control Unit DCU	-	-	-	R
738	Gaugetype	Vacuum pressure gauge type	-	-	-	R/W
794	Param set	Parameter set 0 = basic parameter set; 1 = extended	0	1	0	R/W
795	Servicelin	Insert service line	-	-	795	R/W

¹⁾ R = Parameter readable via interface / W = parameter writeable via interface.

The displaying of more parameters depends on the connected drive units.

6. Error-/Warning Codes

6.1. General

Errors ("Errxxx" or "Error Exxx") always causes to shut-down of the TMP, the fan, the heating and the backing pump.

➔ After the error is removed depress key .

→ The unit is again ready to operate.

Warnings ("Wrnxxx" or "Warning Fxxx") are only displayed and do not cause components to be shut down.

6.2. Errors/Warnings

The following errors can occur during self-testing performed when the DCU is switched on:

Display	Error	Possible action
** Wrn F110 **	<ul style="list-style-type: none"> • Failure at the pressure gauge • Gauge disconnected during operation 	<ul style="list-style-type: none"> • Change pressure gauge • Restart with connected gauge
** Error E040 **	<ul style="list-style-type: none"> • Hardware failure: external RAM defective 	<ul style="list-style-type: none"> • Inform PFEIFFER-Service
** Error E042 **	<ul style="list-style-type: none"> • Hardware failure: EPROM checksum 	<ul style="list-style-type: none"> • Inform PFEIFFER-Service
** Error E090 **	<ul style="list-style-type: none"> • Insufficient RAM • The DCU is connected to the wrong pump electronic 	<ul style="list-style-type: none"> • Inform PFEIFFER-Service • Connect correct pump electronic
** Error E698 **	<ul style="list-style-type: none"> • The connected drive unit does not respond 	<ul style="list-style-type: none"> • Check communication lead between electronic drive unit and DCU, switch on electronic drive unit
** Error E043 **	<ul style="list-style-type: none"> • Hardware failure: E²PROM-writing failure 	<ul style="list-style-type: none"> • Inform PFEIFFER-Service

Further errors and warnings are described in the operating instructions of the electronic drive unit.

7. Maintenance And Service

A damp cloth can be used to wipe away any dirt which has collected on the front panel. Ensure that the unit is first disconnected from the mains power supply.

Do Make Use Of Our Service Facilities

In the event that repairs are necessary a number of options are available to you to ensure any system down time is kept to a minimum:

- Have the unit repaired on the spot by PFEIFFER Service Engineers;
- Return the unit to the manufacturer for repairs;
- Replace with a new value unit.

Local PFEIFFER representatives can provide full details.

Please note:

Units returned to us for repair or maintenance are covered by our general conditions of sale and supply.

Contact addresses and telephone hotline:

Please refer to the back cover of this manual for contact addresses and telephone hotline numbers.

8. Technical Data

8.1. Data List

Definition	Unit	DCU 002	DCU 110	DCU 180	DCU 310	DCU 400
Connection voltage:	V DC	12-30 ¹⁾	–	–	–	–
Connection voltage (-20/+15%):	V AC	–	115-230	115-230	115-230	115-230
Frequency:	Hz	–	50/60	50/60	50/60	50/60
Max. power consumption:	VA	≤ 6	≤ 130	≤ 220	≤ 340	≤ 450
Output voltage (DC out):	VDC	–	24	24	24	48
Max output current (DC out):	A	–	4,6	7,5	12,5	8,4
Permiss. amb. temperature:	°C			5 - 50		
Max. relative humidity ²⁾ :	%			5 - 85		
Air pressure:		86kPa - 106 kPa				
Protection type:		IP 20				
Weight:	kg	0,4	1,2	1,7	1,9	1,9

1) only supplied by PFEIFFER Electronic Drive Unit
 2) non condensing at 5-50°C

8.2. Dimesions

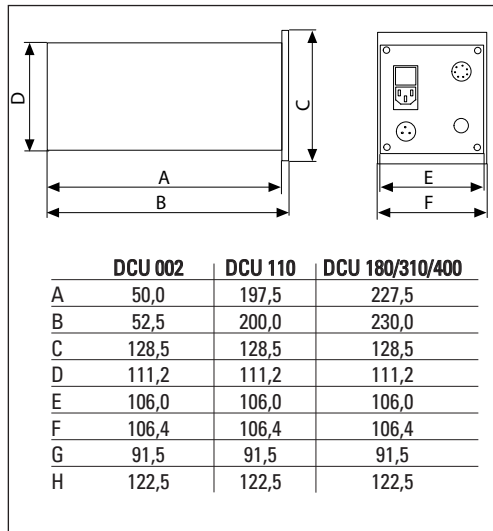
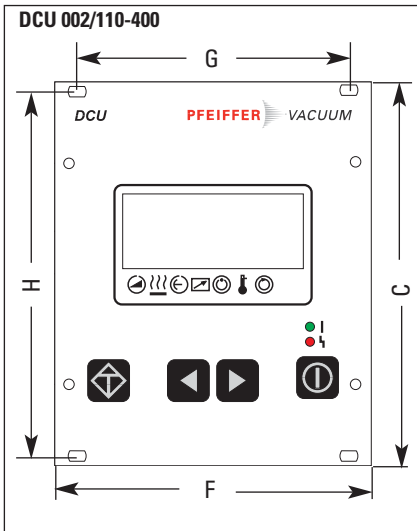

9. Supplementary Information

The Display And Control Unit DCU is a universal component for the control and monitoring of PFEIFFER vacuum pumps and drive units.

Depending on the configuration of your components further operating instructions are included in the delivery consignment. If, despite every effort by us, information on your products is missing please get in touch with your local Pfeiffer representatives or call us on the hotline shown on the back cover page.

All operating instructions are also available as PDF files at www.pfeiffer-vacuum.net.

CE **Konformitätserklärung** **CE**
Declaration of Conformity

im Sinne folgender EU-Richtlinien:
pursuant to the following EU directives:

- **Elektromagnetische Verträglichkeit/ Electromagnetic Compatibility 89/336/EWG**
- **Niederspannung/ Low Voltage 73/23/EWG**

Wir bestätigen Konformität mit der **EU-Richtlinie über elektromagnetische Verträglichkeit 89/336/EWG** und der **EU-Niederspannungsrichtlinie 73/23/EWG**.

We hereby certify that the product specified below is in accordance with the provision of EU Electromagnetic Compatibility Directive 89/336/EEC and EU Low Voltage Directive 73/23/EEC.

Produkt/Product:

DCU 002, DCU 110, DCU 180, DCU 310, DCU 400

Angewendete Richtlinien, harmonisierte Normen und angewendete, nationale Normen:
Guidelines, harmonised standards, national standards in which have been applied:

EN 61010, EN 55011, EN 50081-1, EN 50082-2, IEC 801 1-4, VDE 0843-6

Unterschriften/*Signatures:*



(M. Bender)
Geschäftsführer
Managing Director



(Dr. M. Wiemer)
Geschäftsführer
Managing Director

Pfeiffer-Vacuum GmbH
Berliner Strasse 43
35614 Asslar
Germany

Konf.II/2007

Vacuum is nothing, but everything to us!



Turbo Pumps



Rotary Vane Vacuum Pumps



Roots Pumps



Dry Vacuum Pumps



Leak Test Units



Valves



Flanges, Feedthroughs



Vacuum Measurement



Gas Analysis



System Technology



Service

PFEIFFER  **VACUUM**

Pfeiffer Vacuum Technology AG · Headquarters/Germany
Tel. +49-(0) 64 41-8 02-0 · Fax +49-(0) 64 41-8 02-2 02 · info@pfeiffer-vacuum.de
www.pfeiffer-vacuum.net