



**InstruTech<sup>®</sup>, Inc.**

**Hot Cathode Ionization Vacuum Gauge  
With Dual Convection  
IGM402 Module  
*The Hornet™***



**User Manual**

InstruTech, Inc.  
1475 S. Fordham St.  
Longmont, CO 80503  
USA

Phone: +1-303-651-0551  
Fax: +1-303-678-1754  
E-mail [info@instrutechinc.com](mailto:info@instrutechinc.com)  
[www.instrutechinc.com](http://www.instrutechinc.com)

**NOTICE**

This User Manual is applicable to the InstruTech® Hornet™ model IGM402 product manufactured with firmware p/n 1769 versions 108 or higher. For previous versions of IGM402 manufactured prior to the introduction of firmware p/n 1769-108, please go to <http://www.instrutechinc.com/downloads-archived-user-manuals/> to find the version of user manual applicable to prior versions of IGM402. See [section 5.8.6, SERVICE MENU](#) of this manual to determine the firmware version of your IGM402.

**Important User Information**

There are operational characteristic differences between solid state equipment and electromechanical equipment. Because of these differences, and because there are a variety of uses for solid state equipment, all persons that apply this equipment must take every precaution and satisfy themselves that the intended application of this equipment is safe and used in an acceptable manner.

In no event will InstruTech, Inc. be responsible or liable for indirect or consequential damages that result from the use or application of this equipment.

Any examples or diagrams included in this manual are provided solely for illustrative purposes. Because of the many variables and requirements imposed on any particular installation, InstruTech, Inc. cannot assume responsibility or liability for any actual use based on the examples and diagrams.

No patent liability is assumed by InstruTech, Inc. with respect to use of information circuits, equipment, or software described in this manual.

Throughout this manual we use notes, notices and apply internationally recognized symbols and safety messages to make you aware of safety considerations.

**WARNING**

Identifies information about practices or circumstances that can cause electrical or physical hazards which, if precautions are not taken, could result in death or serious injury, property damage, or economic loss.

**CAUTION**

Identifies information about practices or circumstances that can cause electrical or physical hazards which, if precautions are not taken, could result in minor or moderate injury, property damage, or economic loss.

**NOTICE**

Identifies information that is critical for successful application and understanding of the product.

**SHOCK HAZARD**

Labels may be located on or inside the device to alert people that dangerous voltages may be present.

*Copyright © 2011 by InstruTech®, Inc.*

*All rights reserved. No part of this work may be reproduced or transmitted in any form or by any means, electronic or mechanical, including photocopying and recording, or by any information storage or retrieval system, except as may be expressly permitted in writing by InstruTech, Inc.*

*Printed in the United States of America*

Granville-Phillips® and Convectron® are registered trademarks of MKS Instruments, Andover, MA  
Conflat® is a registered trademark of Varian, Inc. / Agilent Technologies, Lexington, MA.  
Teflon® is a registered trademark of E. I. du Pont de Nemours and Company, Wilmington, DE.  
Swagelok®, Cajon®, VCR® are registered trademarks of the Swagelok Company, Solon, OH.  
Hyperterminal® is a registered trademark of Hilgraeve, Inc., Monroe, MI

## Table of Contents

1	Introduction / General Information.....	5
1.1	Description .....	5
1.2	Specifications .....	5
1.3	Dimensions.....	6
1.4	Part Numbers .....	6
1.5	Options & Accessories.....	7
2	Important Safety Information.....	8
2.1	Safety Precautions - General.....	8
2.2	Safety Precautions - IGM402 service and operation.....	9
2.3	Safety Precautions - CVG101 service and operation.....	10
2.4	Electrical Conditions.....	10
2.4.1	Proper Equipment Grounding.....	11
2.4.2	Electrical Interface and Control.....	11
2.5	Overpressure and use with hazardous gases.....	11
2.6	Gases other than nitrogen / air.....	12
3	Installation .....	12
3.1	Mechanical Installation - IGM402 ionization gauge.....	12
3.2	Mechanical Installation - CVG101 convection gauge.....	13
3.3	Electrical Installation .....	14
3.3.1	Grounding.....	14
3.3.2	Connectors .....	14
3.3.2.1	ANALOG connector pin-out for IGM402 .....	15
3.3.2.2	RS485 COM / Relay Connector pin-out for IGM402 .....	16
3.3.2.3	Analog output and setpoint relays for CG1 and CG2 .....	17
4	Bakeout.....	18
4.1	Bakeout - Ionization gauge sensor .....	18
4.2	Bakeout - Convection vacuum gauges CG1 and CG2 .....	18

- 5 Setup and Operation.....19
  - 5.1 Applying power .....19
  - 5.2 Emission Current .....19
  - 5.3 Overpressure shut down.....19
  - 5.4 Degas.....20
  - 5.5 Filament Material Selection / Venting the Chamber .....20
  - 5.6 User Interface Basics .....21
  - 5.7 Factory-Set Default Parameters.....22
  - 5.8 Programming.....24
    - 5.8.1 SETUP DISP .....25
    - 5.8.2 SETUP UNIT .....29
    - 5.8.3 SETUP IG.....32
    - 5.8.4 SETUP CGS.....34
      - 5.8.4.1 SETUP CG1.....35
      - 5.8.4.2 SETUP CG2.....37
    - 5.8.5 SETUP COMMS.....38
    - 5.8.6 SERVICE MENU .....38
  - 5.9 Activating the IG sensor .....39
  
- 6 Analog output .....39
  - 6.1 Ion gauge analog output - IG ONLY .....40
  - 6.2 Ion gauge plus convection gauge analog output - IG + CG1 .....41
  - 6.3 Convection gauge analog output - LOG-LINEAR .....42
  - 6.4 Convection gauge analog output - NON-LINEAR .....43
  
- 7 Using the gauge with different gases .....45
  - 7.1 Effects of different gas types on ionization gauge display.....45
    - 7.1.1 Ion gauge display correction factors for selected gases .....46
  - 7.2 Effects of different gases on convection gauge display .....46
    - 7.2.1 Convection gauge display conversion for selected gases .....48
  - 7.3 Effect of different gases on analog output .....50
    - 7.3.1 Ion gauge analog output correction factors for selected gases.....50

- 7.3.2 IG + CG1 analog output correction factors for selected gases.....51
  - 7.3.2.1 IG + CG1 analog output correction factors - Ion gauge range .....51
  - 7.3.2.2 IG + CG1 analog output correction factors - Convection gauge range .....52
- 7.3.3 Convection gauge analog output for selected gases .....53
  - 7.3.3.1 Log-Linear CG analog output correction factors .....53
  - 7.3.3.2 Non-Linear CG analog output correction factors .....54
- 8 RS485 serial communications .....55
  - 8.1 Device Specific Serial Communication Info - BINARY Protocol with CRC8.....55
  - 8.2 RS485 Command Protocol Summary - BINARY Protocol with CRC8 .....58
  - 8.3 Device Specific Serial Communication Info - ASCII Protocol .....66
  - 8.4 RS485 Command Protocol Summary - ASCII Protocol .....67
- 9 Service.....71
  - 9.1 Calibration .....71
  - 9.2 Troubleshooting - Operation.....71
  - 9.3 Troubleshooting - Error Messages .....72
  - 9.4 Troubleshooting - Filaments F1 or F2 open .....73
  - 9.5 R & D (Research) Diagnostic Display .....74
  - 9.6 Maintenance .....76
  - 9.7 Contamination.....76
  - 9.8 Sensor Replacement.....78
- 10 Factory Service and Support .....79
- 11 Warranty .....79

## 1 Introduction / General Information

### 1.1 Description

A hot cathode ionization gauge (IG) measures vacuum pressure by ionizing gas atoms and molecules inside the vacuum region of the gauge transducer and measuring the quantity of ions produced. The measurement of the resulting ion current is directly proportional to the density of gas inside the gauge transducer therefore proportional to the pressure. As pressure inside the vacuum system drops, there are fewer ions created and therefore ion current measured is lower translating to a lower pressure reading.

The InstruTech® IGM402 *Hornet*™ module provides the basic signal conditioning required to turn a hot cathode ionization vacuum gauge into a complete measuring instrument. In addition, the IGM402 is capable of operating two external convection vacuum gauges simultaneously. The module provides three log-linear analog outputs, three setpoint relays and RS485 serial communications. A built-in display provides a convenient user interface for setup and operation of the vacuum gauges. The measurement range for the hot cathode ionization gauge part of the InstruTech IGM402 is  $1 \times 10^{-9}$  to  $5 \times 10^{-2}$  Torr. The IGM402 can combine the vacuum measurement from the ion gauge and a convection gauge to provide wide range vacuum measurements from  $1 \times 10^{-9}$  to 1,000 Torr, or simply operate the ion gauge and the two convection gauges as individual gauges.

### 1.2 Specifications

measurement range:	ionization (IG)	$1 \times 10^{-9}$ to $5 \times 10^{-2}$ Torr / $1.3 \times 10^{-9}$ to $6.7 \times 10^{-2}$ mbar / $1.3 \times 10^{-7}$ to 6.7 Pa
	convection (CG)	$1 \times 10^{-4}$ to 1,000 Torr / $1.3 \times 10^{-4}$ to 1,333 mbar / $1.3 \times 10^{-2}$ Pa to 133 kPa
	used as a wide range gauge (IG+CG)	$1 \times 10^{-9}$ to 1,000 Torr / $1.3 \times 10^{-9}$ to 1,333 mbar / $1.3 \times 10^{-7}$ Pa to 133 kPa
accuracy - N <sub>2</sub> (typical)		$1 \times 10^{-8}$ to $1 \times 10^{-3}$ Torr; ± 15% of reading $1 \times 10^{-3}$ to 400 Torr; ± 10% of reading, 400 to 1,000 Torr; ± 2.5% of reading
repeatability - (typical)		$1 \times 10^{-8}$ to $1 \times 10^{-3}$ Torr; ± 5% of reading $1 \times 10^{-3}$ to 1,000 Torr; ± 2% of reading
display		bright OLED display, 3 digits plus 2 digits exponent, user-selectable Torr, mbar, or Pa
functionality		ionization gauge can operate up to 2 convection gauges
materials exposed to gases		dual filaments: yttria coated iridium or optional tungsten Ion collector: tungsten Grid: tantalum Others: 316/304 SS, glass, nickel
sensitivity		factory pre-set. Also user adjustable between 2 to 99
x-ray limit		$< 5 \times 10^{-10}$ Torr, $< 6.7 \times 10^{-10}$ mbar, $< 6.7 \times 10^{-8}$ Pa
emission current		100 $\mu$ A, 4 mA
degas		3 W, electron bombardment
overpressure protection		gauge turns off at factory default setting of $5 \times 10^{-2}$ Torr
internal gauge volume		1.0 in <sup>3</sup> (16.4 cm <sup>3</sup> )
temperature		operating; 0 to + 40 °C storage; -40 to + 70 °C
bakeout temperature		200 °C (sensor only - electronics removed)
humidity		0 to 95% RH non-condensing
weight		0.6 lb. (0.27 kg) with NW25 KF flange
housing (electronics)		aluminum extrusion
mounting orientation		any
altitude		operating; 8,200 ft. (2,500 m) max storage; 41,000 ft. (12,500 m) max
serial communications		RS485 - User selectable BINARY protocol using InstruTech CRC8, or ASCII protocol; minimum command interval: 50 ms
analog outputs (3 total)	IG	one log-linear 0 to 9 Vdc, 1 V/decade, or
	IG+CG	one log-linear 0.5 to 7 Vdc, 0.5 V/decade, and
	CG	two log-linear 1 to 8 Vdc, 1 V/decade or non-linear 0.375 to 5.659 Vdc

**Specifications - continued**

setpoint relays (3 total)	three single-pole, double-throw (SPDT), 1 A at 30 Vdc resistive, or ac non-inductive
status outputs	degas & filament on/off status via display messages, open collector transistor or RS485
input signal	degas and filament on/off & emission current are set by continuity to ground using digital inputs, RS485 or manually using front panel soft-keys
filament selection	filament 1 or 2 selectable via front panel soft-keys or RS485 commands
input power	20 to 28 Vdc, 30 W protected against power reversal and transient over-voltages
connectors	(2) 9-pin D-Sub, (2) terminal blocks, (2) convection gauge connectors
convection gauge compatibility	InstruTech CVG101 <i>Worker Bee™</i> or Granville-Phillips® 275 Convectron®
CE compliance	EMC Directive 2004/108/EC, EN61326-1, EN55011 Low Voltage Directive 2006/95/EC, EN61010-1
environmental	RoHS compliant

**1.3 Dimensions**

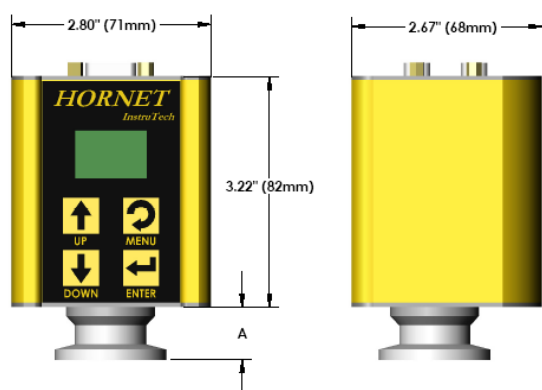

fitting	dimension A
NW16KF	1.45 in. (37mm)
NW25KF	1.45 in. (37mm)
NW40KF	1.45 in. (37mm)
1 1/3 in. Mini CF	1.85 in. (47 mm)
2 3/4 in. Conflat®	1.70 in. (43 mm)
3/4 in. Tube	2.16 in. (55 mm)
1/2 in. VCR	2.58 in. (65 mm)

**1.4 Part Numbers**

<u>IGM402 Fittings / Flanges</u>	<u>With Yttria Filaments</u>	<u>With Tungsten Filaments</u>	<u>Replacement Sensor - Yttria</u>	<u>Replacement Sensor - Tungsten</u>
NW16KF	IGM402YBD	IGM402TBD	IG4YB	IG4TB
NW25KF	IGM402YCD	IGM402TCD	IG4YC	IG4TC
NW40KF	IGM402YDD	IGM402TDD	IG4YD	IG4TD
1 1/3 in. Mini-CF/NW16CF Mini-Conflat®	IGM402YED	IGM402TED	IG4YE	IG4TE
2 3/4 in. CF / NW35CF Conflat®	IGM402YFD	IGM402TFD	IG4YF	IG4TF
3/4 in. Tube (3/4 in. O.D. O-ring compression)	IGM402YAD	IGM402TAD	IG4YA	IG4TA
1/2 in. Cajon® 8VCR® female	IGM402YHD	IGM402THD	IG4YH	IG4TH

<u>IGM402 / CVG101 convection gauge cable</u>	<u>P/N</u>
Cable, IGM402 to CVG101, 3 ft. (1m)	HB431-1-03F
Cable, IGM402 to CVG101, 10 ft. (3m)	HB431-1-10F
Cable, IGM402 to CVG101, 25 ft. (8m)	HB431-1-25F
Cable, IGM402 to CVG101, 50 ft. (15m)	HB431-1-50F

**Note** - For convection gauge product and installation information refer to CVG101 Worker Bee™ User Manual.



### 1.5 Options & Accessories

#### PS501-A

Compatibility: Powers the IGM402 *Hornet™* vacuum gauge module

Power Input: 100 - 240 Vac

Power Plug: North American 115 Vac

Output: 24 Vdc @ 2.5 A (60 W)

Connector: 9-pin D-sub female to mate with and power the IGM401 module

Cable length: 6 ft. (2 m)

Note: 9-pin D-sub connector backshell can be opened to enable connections to signals and relays



## 2 Important Safety Information

InstruTech has designed and tested this product to provide safe and reliable service, provided it is installed and operated within the *strict safety guidelines provided in this manual*. **Please read and follow all warnings and instructions.**



**To avoid serious injury or death, follow the safety information in this document. Failure to comply with these safety procedures could result in serious bodily harm, including death, and or property damage.**

Failure to comply with these warnings violates the safety standards of installation and intended use of this instrument. InstruTech, Inc. disclaims all liability for the customer's failure to comply with these instructions.

Although every attempt has been made to consider most possible installations, InstruTech cannot anticipate every contingency that arises from various installations, operation, or maintenance of the module. If you have any questions about the safe installation and use of this product, please contact InstruTech.

This device meets FCC part 15 requirements for an unintentional radiator, class A.

### 2.1 Safety Precautions - General

Hazardous voltages are present with this product during normal operation. The product should never be operated with the covers removed unless equivalent protection of the operator from accidental contact with hazardous internal voltages is provided.

 **WARNING!** There are no operator serviceable parts or adjustments inside the product enclosure; refer servicing to service trained personnel.

Do not modify this product or substitute any parts without authorization of qualified InstruTech service trained personnel. Return the product to an InstruTech qualified service and repair center to ensure that all safety features are maintained. Do not use this product if unauthorized modifications have been made.

 **WARNING!** Source power must be removed from the product prior to performing any servicing.

After servicing this product, ensure that all safety checks are made by a qualified service person. When replacement parts are required, ensure that the parts are specified by InstruTech. Substitutions of non-qualified parts may result in fire, electric shock or other hazards. Use of unauthorized parts or modifications made to this product will void the warranty.

To reduce the risk of fire or electric shock, do not expose this product to rain or moisture. These products are not waterproof and careful attention must be paid to not spill any type of liquid onto these products. Do not use these products if they have been damaged. Immediately contact InstruTech, Inc. to arrange return of the product if it is damaged.

Due to the possibility of corrosion when used in certain environmental conditions, it is possible that the product's safety could be compromised over time. It is important that the product be periodically inspected for sound electrical connections and equipment grounding. Do not use if the equipment grounding or electrical insulation has been compromised.

## 2.2 Safety Precautions - IGM402 service and operation

Ensure the IGM402 is properly connected to earth ground.

Do not turn on filaments and try to activate the sensor when pressure exceeds  $1.00 \times 10^{-3}$  Torr if the device is operating at the 4 mA emission current setting.

Do not turn on the filaments and try to activate the sensor when pressure exceeds  $5.00 \times 10^{-2}$  Torr if the device is operating at the 100  $\mu$ A emission current setting.

Ensure vacuum level is at or less than  $5.00 \times 10^{-5}$  Torr before attempting to initiate degas.

 **WARNING!** The power supply used in the IGM402 hot cathode gauge module is subject to high voltages which could cause severe injury or death. In order to prevent electric shock and bodily harm, the user should wait 5 minutes after power is removed before touching the IGM402 power supply components.

 **WARNING!** When the IGM402 is turned on, 180 V is present at the power supply and other components such as the ion gauge and the cable. Furthermore, voltages as high as 350 V are present during degas. **DO NOT** operate the IGM402 with the IGM402 enclosure removed. Contact with exposed electrical circuits in the IGM402 could result in death or serious injury.

### NOTICE

Do not use another gauge to automatically turn off the ion gauge when the ion gauge filament in use is constructed of tungsten (yttria coated filament is ok). The response time of other gauges may not allow for timely turn off of the tungsten filament leading to filament damage. Always turn off the IG filament manually before pressure is to rise above  $1.00 \times 10^{-3}$  Torr.

When using yttria coated filaments, it is highly recommended to periodically alternate operating Filaments 1 and 2. An inactive filament not operating for an extended length of time may result in that filament failing to establish emission current when it is eventually used. This will be more problematic in dirty applications.

Use an appropriate power source of 20 to 28 Vdc, 30 W min. (InstruTech PS501 power supply is rated 60 W).

Turn off power to the unit before attempting to service the module. Turn off power to the unit before detaching the electronics from the sensor for sensor replacement or bake-out purposes.

Turn off power to the unit if a cable or plug is damaged or the product is not operating normally according to this instruction manual.

Do not use if the unit has been dropped or the enclosure has been damaged. Contact InstruTech for return authorization and instructions for returning the product to InstruTech for evaluation.

Use yttria coated filaments with air and inert gases such as N<sub>2</sub>, argon, etc. Optional tungsten filaments are available for use with gases not compatible with yttria filaments.

The most common cause of all vacuum gauge failures is contamination of the sensor. Noisy or erratic readings and total gauge failure are possible indications of gauge contamination. Contamination can generally be characterized as either:

- A) A physical or chemical reaction of process gases with the sensor element. A different gauge may be considered if neither yttria coated nor tungsten filament sensor materials are compatible with your application.
- B) An accumulation of material on the sensor element. In this case, performing the degas function of the instrument may resolve the issue.

### **2.3 Safety Precautions - CVG101 service and operation**

Refer to the CVG101 convection gauge User Manual and information listed below for safe operation of the device. Ensure that the vacuum port on which the CVG101 vacuum gauge is mounted is electrically grounded. Remove cable to the unit before attempting to service the gauge.

Remove cable to the unit if a cable or plug is damaged or the product is not operating normally according to this User Manual. Contact qualified InstruTech service personnel for any service or troubleshooting condition that may not be covered by this User Manual.

It is important that the product be periodically inspected for sound electrical connections and equipment grounding. Do not use if the equipment grounding or electrical insulation has been compromised.

Do not use if the unit has been dropped. Contact InstruTech for further instructions regarding evaluation of the damaged sensor.

### **2.4 Electrical Conditions**

 **WARNING!** When high voltage is present in any vacuum system, a life threatening electrical shock hazard may exist unless all exposed electrical conductors are maintained at earth ground potential. This applies to all products that come in contact with the gas contained in vacuum chambers. An electrical discharge within a gaseous environment may couple dangerous high voltage directly to any ungrounded conductor of electricity. A person could be seriously injured or killed by coming in contact with an exposed, ungrounded electrical conductor at high voltage potential. This condition applies to all products that may come in contact with the gas inside the vacuum chamber (vacuum/pressure containment vessel).

### 2.4.1 Proper Equipment Grounding

 **WARNING!** Hazardous voltages that could seriously injure or cause death are present in many vacuum processes. Verify that the vacuum connection ports on which the ion gauge and the convection gauges are mounted are electrically grounded. Consult a qualified Electrician if you are in doubt about your equipment grounding. Proper grounding of your equipment is essential for safety as well as intended operation of the equipment. The vacuum gauge transducers and enclosure of any control module must be connected directly to a good quality equipment earthing conductor. Use a ground lug on the vacuum connection flange of the pressure measurement devices if necessary.

 **WARNING!** In order to protect personnel from electric shock and bodily harm, shield all conductors which are subject to potential high voltage electrical discharges in or around the vacuum system.

### 2.4.2 Electrical Interface and Control

It is the user's responsibility to ensure that the electrical signals from this product and any connections made to external devices, for example, relays and solenoids, are used in a safe manner. Always double check the system set-up before using any signals to automate your process. Perform a hazardous operation analysis of your system design and ensure safeguards and personnel safety measures are taken to prevent injury and property damage.

## 2.5 Overpressure and use with hazardous gases

 **WARNING!** Install suitable protective devices that will limit the level of pressure inside your vacuum chamber to less than what the vacuum chamber system components are capable of withstanding.

In cases where an equipment failure could cause a hazardous condition, always implement fail-safe system operation. For example, use a pressure relief device in an automatic backfill operation where a malfunction could result in high internal pressures if the pressure relief device was not installed on the chamber.

The IGM402 and the CVG101 are not intended for use at pressures above 20 psia (1000 Torr); DO NOT exceed 35 psig (< 2 ½ bars) pressure inside the sensor. If your chamber goes to higher pressures, you should install an isolation valve or pressure relief device to protect the gauge tube from overpressure conditions. With some fittings, actual safe overpressure conditions may be lower; for example, a quick-connect, O-ring compression fitting may forcibly release the gauge tube from the vacuum chamber fitting with only a few psi over local uncorrected barometric (atmospheric) pressure.

 **CAUTION!** If the internal pressure of a vacuum gauge device is allowed to increase above local uncorrected barometric pressure (atmospheric pressure side), vacuum fittings may release and possible overpressure conditions may cause leaks that would allow the gas inside the gauge tube to release into the atmosphere of the surrounding environment. Toxic, pyrophoric and flammable gases are examples of hazardous gases that if allowed to leak out of the vacuum/pressure containment vessel into the atmospheric environment, could cause bodily injury and possible damage to equipment. Never expose the gauge tube internal volume to pressure above local atmospheric pressure when using hazardous gases.

## 2.6 Gases other than nitrogen / air

**⚠ WARNING!** Do not attempt to use with gases other than nitrogen (N<sub>2</sub>) or air without referring to correction factor data tables. InstruTech gauges and modules are calibrated for direct readout of nitrogen or air. Do not attempt to use with other gases such as argon (Ar) or carbon dioxide (CO<sub>2</sub>), unless you have applied correction factors to both the displayed pressure and the analog output to determine the true measured pressure. This is particularly critical when using convection gauges to measure pressure of gases other than N<sub>2</sub>/Air.

**⚠ WARNING!** Do not use the IGM402 in an explosive atmosphere or in the presence of flammable gases, vapors or fumes. Do not use this device to measure the pressure of explosive or combustible gases or gas mixtures. The sensor filaments operate at incandescent temperatures and could become an ignition source. This could cause an explosion which could result in serious injury or death.

**⚠ WARNING!** Do not use the CVG101 in an explosive atmosphere or in the presence of flammable gases, vapors or fumes. Do not use this device to measure the pressure of explosive or combustible gases or gas mixtures. The sensor wire in the gauge normally operates at 125 °C, but if malfunction should occur, the wire temperature could exceed the ignition temperature of certain combustible gases and gas mixture. This could cause an explosion which could result in serious injury or death.

## 3 Installation

### 3.1 Mechanical Installation - IGM402 ionization gauge

Mount the IGM402 as close as possible to the pressure you want to measure. Long or restricted, small diameter tubing will create a pressure difference between your process chamber and the gauge. This may cause a delay in response to pressure changes. Mounting the IGM402 too close to a gas source inlet may also cause measurement and control instability.

The IGM402 can be mounted in any orientation, however, if possible, mount the gauge with port down to help minimize the effect of any particles or condensation collecting in the gauge.

Do not mount the IGM402 where it will be subjected to excessive vibration. Vibrations may cause unstable readings, measurement errors and possible mechanical stress to components in the IGM402.

Shield the IGM402 near ion or electron sources such as an electron beam or in a sputtering system.

For electrical safety purposes the housing of the gauge must be grounded to the vacuum chamber. When using KF flanges, metal clamps must be used to ensure proper grounding. Do not attempt to modify your flange in order to use non-metallic-type flange clamps.

Fittings/Flanges - follow the fitting/flange manufacturer's recommendations for installation and use. Use all metal vacuum fittings with metal seals when operating pressures are expected to be below  $1.00 \times 10^{-7}$  Torr ( $1.33 \times 10^{-7}$  mbar,  $1.33 \times 10^{-5}$  Pa).

### 3.2 Mechanical Installation - CVG101 convection gauge

Mount the CVG101 as close as possible to the pressure you want to measure. Long or restricted, small diameter tubing will create a pressure difference between your process chamber and the gauge. This may cause a delay in response to pressure changes.

Mounting the CVG101 too close to a gas source inlet may also cause measurement and control instability. Do not mount the CVG101 near a source of heating or cooling, such as heaters or air conditioning vents.

Mount the CVG101 with its main axis horizontal (see diagram below). Pressure reading errors may occur above 1 Torr if the unit is not mounted horizontally. Below 1 Torr, mounting position has little to no effect.

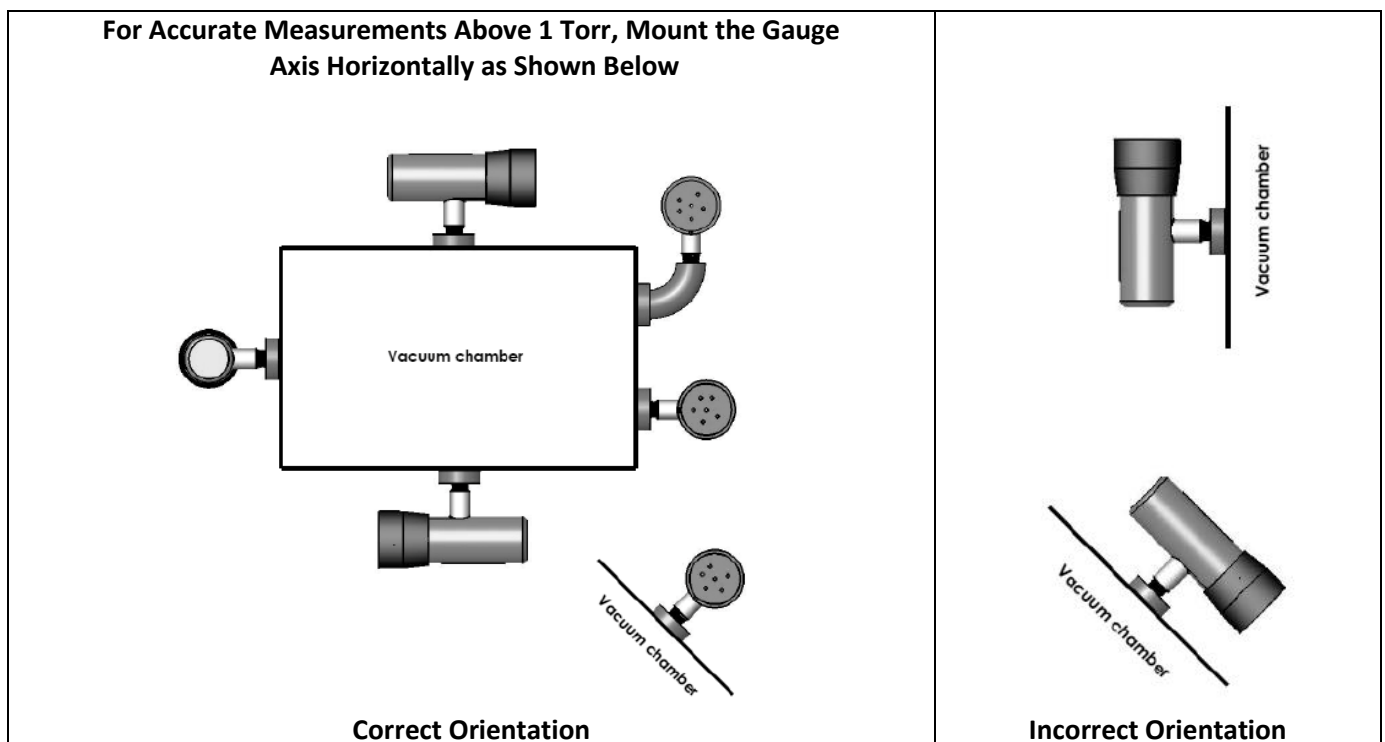

Mount the CVG101 with port down, if possible, to help minimize the effect of any particles or condensation from collecting in the gauge.

Do not mount the CVG101 where it will be subjected to excessive vibration. Vibrations may cause unstable readings, measurement errors and possible mechanical stress to components in the CVG101.

Flanges/ Fittings - follow the manufacturer's recommendations and note the following:

- NPT fittings: When connecting the device using a NPT fitting, apply a thread sealant compound or wrap the threaded portion of the tubing with one-and-a-half to two wraps of pipe thread seal tape such as PTFE (Teflon®) tape and hand tighten the gauge into the gauge port. Do not use a wrench or other tool which may damage the gauge.

### 3.3 Electrical Installation

#### 3.3.1 Grounding

**⚠** Be sure the vacuum gauges and the rest of your vacuum system are properly grounded to protect personnel from shock and injury. Be aware that some vacuum fittings, especially those with O-rings when not used with metal clamps, may not produce a good electrical connection between the gauge and the chamber it is connected to. Use a ground lug on the vacuum connection flange of the pressure measurement device if necessary.

#### 3.3.2 Connectors

The IGM402 allows for operation of the unit including turning the gauge/filaments on/off, selecting emission current and turning degas on/off using digital inputs, RS485 communication commands or the front panel soft-keys.

Good, recommended practice is to remove power from any cable prior to connecting or disconnecting it.

The IGM402 is provided with two D-sub connectors used for I/O interface as shown below:

1. 9-pin D-sub male (DE-9P) connector for Digital I/O and analog output.
2. 9-pin D-sub female (DE-9S) connector for RS485 serial communications and ion gauge relay connections.

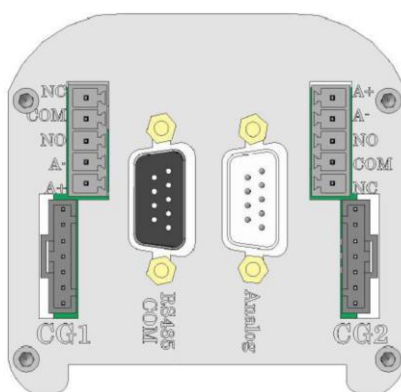

**IGM402 I/O Interface**

When using InstruTech's power Supply PS501A, connect the power supply to the ANALOG connector. If using a power supply other than InstruTech's PS501A, connect your power supply to either the RS485 or the ANALOG connector as shown on the next page.

**⚠ CAUTION!** Do not connect power to both the Analog and RS485 COM connectors.

Fabricate a cable according to your interface requirements. For analog signals and digital inputs use the 9-pin D-Sub male (DE-9P) connector. For ion gauge relay connections and serial communications use the 9-pin D-Sub female (DE-9S) connector. For convection gauge analog and relay connections use the green terminal blocks. Refer to the following pages for detailed explanations of the various connector pin-outs.



### 3.3.2.1 ANALOG connector pin-out for IGM402

**⚠ CAUTION!** Do not connect power to both the Analog and the RS485 connectors. Apply power only to one or the other. Applying power to both connectors may cause damage to the gauge and other connected devices.

**ANALOG I/O 9-Pin D-sub male (DE-9P) connector**

PIN NUMBER	PIN DESCRIPTION
1	Sensor on/off input signal. The ion gauge (IG) filament is activated by applying a continuous ground <sup>1</sup> (0 Vdc). This will activate the sensor and will turn on the filament. The IG filament is turned off by removing the ground. See <a href="#">section 5.9</a> for other methods of activating the sensor.
2	Power ground & sensor on/off ground.
3	Analog output: log-linear 0 to 9 Vdc, 1 V/decade - IG only or log-linear 0.5 to 7 Vdc, 0.5 V/decade when used as a wide range gauge with one convection gauge.
4	Power input (20-28 Vdc at 30 W, minimum). Do not connect power to both the Analog and the RS485 connectors. Apply power only to one or the other.
5	Degas status output signal. This is an output signal to other external instruments to confirm degas is on or off. Signal: Open collector transistor (grounded emitter) rated at 40 V max. $V_{CE}$ , 50 mA $I_C$ max. Transistor off = degas off, transistor on = degas on.
6	Degas on/off Input signal. Degas is initiated by applying a momentary ground. The degas cycle will last for 2-10 minutes (based on user setting) even if ground is removed. The ground must be removed to start cycle again.
7	Analog output signal ground (Do not use for sensor on/off ground).
8	Emission current. Applying ground changes emission current from 100 $\mu$ A to 4 mA.
9	Sensor status. This is an output signal switch to other external instruments to confirm IG filament is on or off. Signal: Open collector transistor (grounded emitter) rated at 40 V max. $V_{CE}$ , 50 mA $I_C$ max. Transistor off = IG filament off, transistor on = IG filament on.

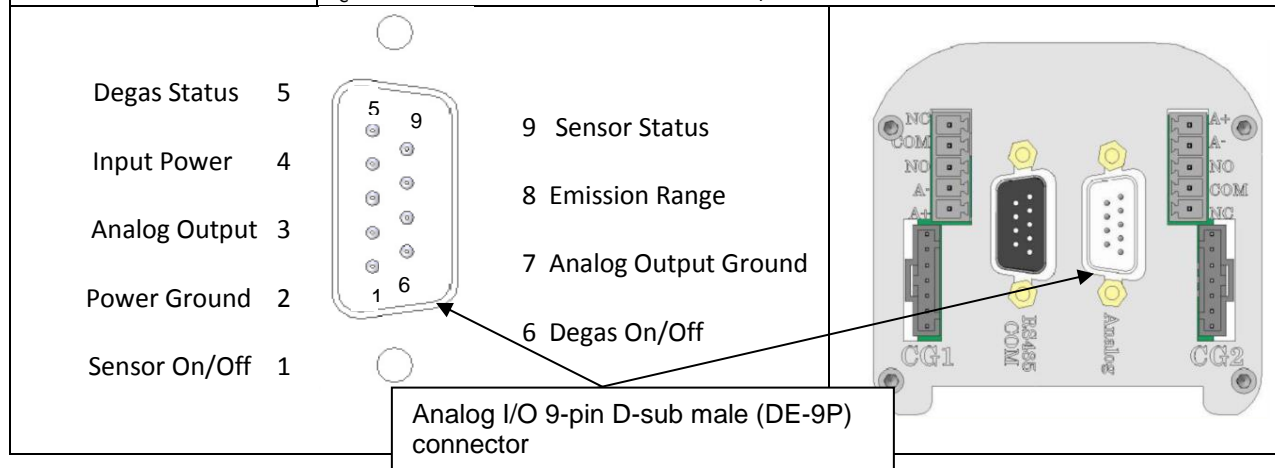

<sup>1</sup> When reading the context under the section of the table above titled PIN DESCRIPTION, references to “ground” are relative to pin 2 of the ANALOG I/O connector which is the Power Ground or power supply common connection.

### 3.3.2.2 RS485 COM / Relay Connector pin-out for IGM402

**⚠ CAUTION!** Do not connect power to both the Analog and the RS485 connectors. Apply power only to one or the other. Applying power to both connectors may cause damage to the gauge and other connected devices.

When using the RS485 serial communications mode of operation, use the 9-pin D-sub (DE-9S) female RS485 COM connector as described below. The same connector is also used for ion gauge setpoint relay connections.

**RS485 COM / Relay 9-Pin D-sub female (DE-9S) connector**

PIN NUMBER	PIN DESCRIPTION
1	Setpoint relay - Normally Open; referred to as RLY I on front panel display
2	Power input (20-28 Vdc at 30 W, minimum). Do not connect power to both the Analog and the RS485 connectors. Apply power only to one or the other.
3	No connection
4	Power ground (Also when using RS485 serial communications, connect this pin to ground pin of your RS485 converter)
5	Setpoint relay - Normally Closed contact (RLY I on front panel display)
6	RS485 DATA A (-) Input/output
7	Setpoint Relay - Common contact (RLY I on front panel display)
8	Not used (do not connect)
9	RS485 DATA B (+) Input/output

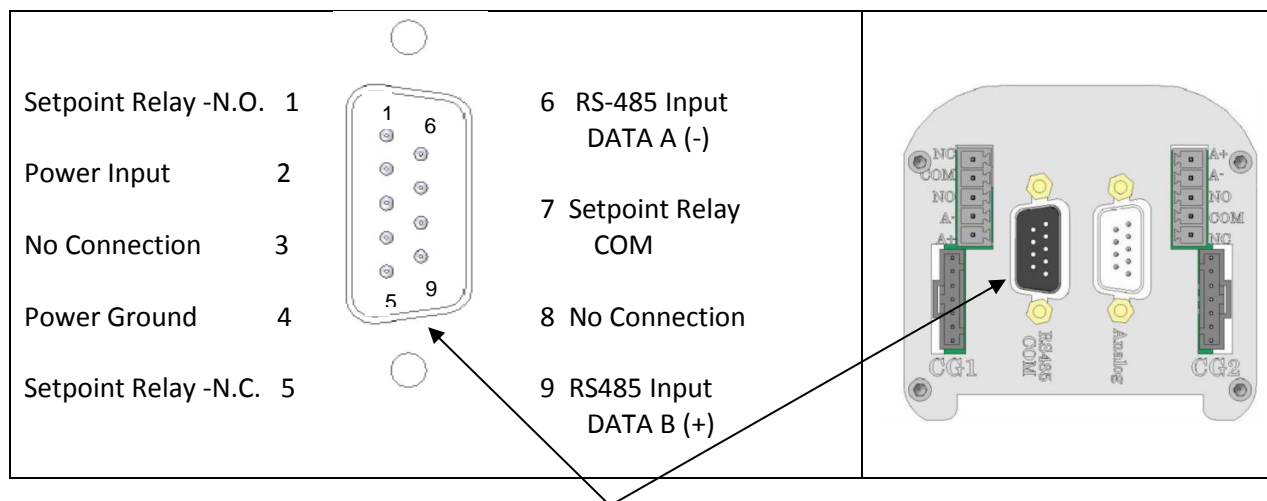

**RS485 COM / IG Setpoint Relay 9-Pin D-sub female (DE-9S) connector**

**NOTICE**

Do not connect power to both connectors. Furthermore, if you are using InstruTech’s PS501-A power supply and using the RS485 function do not connect power to pins 2 and 4 of the RS485 COM connector. The power will be received from the PS501A power supply via the ANALOG connector. Use the RS485 COM connector pins for communications and setpoint relay only. If you intend to operate the IGM402 via RS485 communications only, device power may be connected to the IGM402 using pins 2 and 4 of the RS485 COM connector. See CAUTION at [Section 5.1](#) Pin-out assignments are not the same, especially for the +24 Vdc power and ground (power return) connections for the Analog and RS-485 COM DE-9 connectors.

### 3.3.2.3 Analog output and setpoint relays for CG1 and CG2

When using analog outputs and set-point relays for CG1 and CG2, use the green terminal blocks as described below:

**IGM402 CG1 and CG2 convection gauge I/O connectors**

Connection	Description
A +	Analog outputs for convection gauges CG1 or CG2: log-linear 1 to 8 Vdc, 1 V/decade or Non-Linear S-Curve 0.375 to 5.659 Vdc
A -	Analog signal ground. Use only as analog output ground.
NO	Setpoint relays for CG1 or CG2 - Normally Open contact
COM	Setpoint relay - Common contact (program screen for relays = RLY A / RLY B)
NC	Setpoint relays for CG1 or CG2 - Normally Closed contact

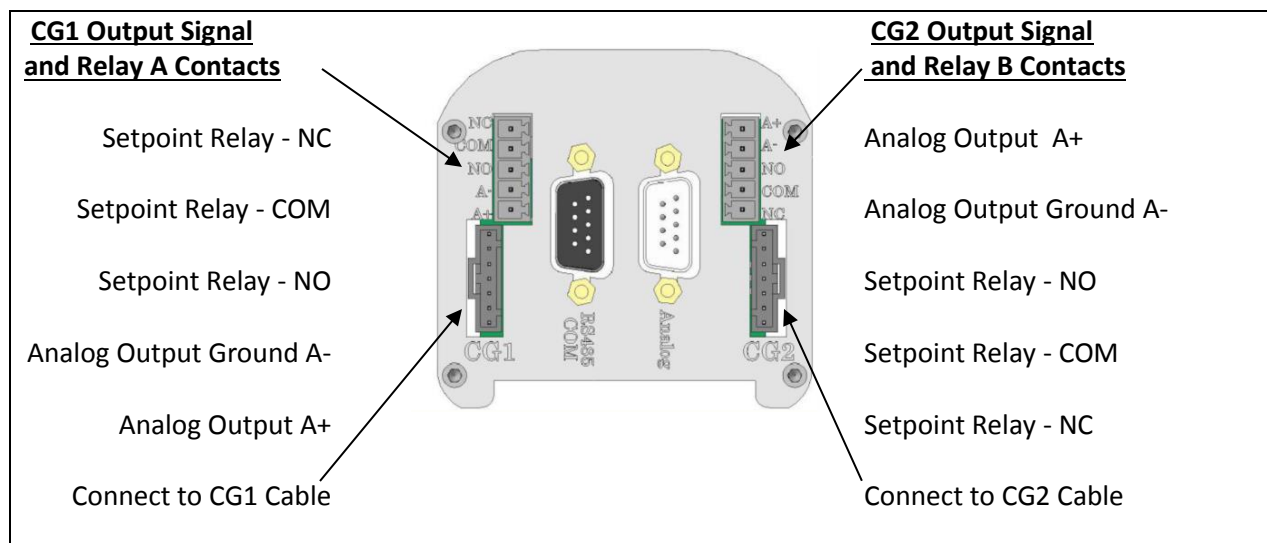

**IGM402 I/O Terminal Blocks for CG1, CG2, RELAY A and RELAY B**

See [section 5.8.4](#). – ASSIGN RLY A and ASSIGN RLY B for details on programming the CG device assigned to control RLY A and RLY B.

## 4 Bakeout

### 4.1 Bakeout - Ionization gauge sensor

If desired, a chamber bake may be performed for new systems or after routine maintenance. The IGM402 sensor can be baked out to 200 °C as long as the sensor fitting uses metal seals. For sensor fittings using elastomer O-rings, the maximum bakeout temperature is limited to the maximum temperature rating of the elastomer O-ring. Ensure the temperature of the sensor tube and the vacuum fitting to the sensor is at the same or above the chamber temperature. The electronic module must be removed from the sensor if the bakeout temperature is to exceed 70 °C. To bake out the sensor use the following procedure:

1. Turn off power to the IGM402.
2. Disconnect the cable from the IGM402.
3. Use a 3/32 in. size Hex key to remove the #4-40 socket head cap screws (SHCS) as shown below.
4. Detach the metal enclosure and the electronics from the sensor. Gently pull the electronics enclosure away from the sensor using a gentle rocking motion.
5. The black plastic cap attached to the sensor and the end plate does not have to be removed for bakeout.
6. Perform bake out with the electronics removed.
7. Reattach the electronics enclosure. Reinstall the 4-40 SHCS (4 ea.)

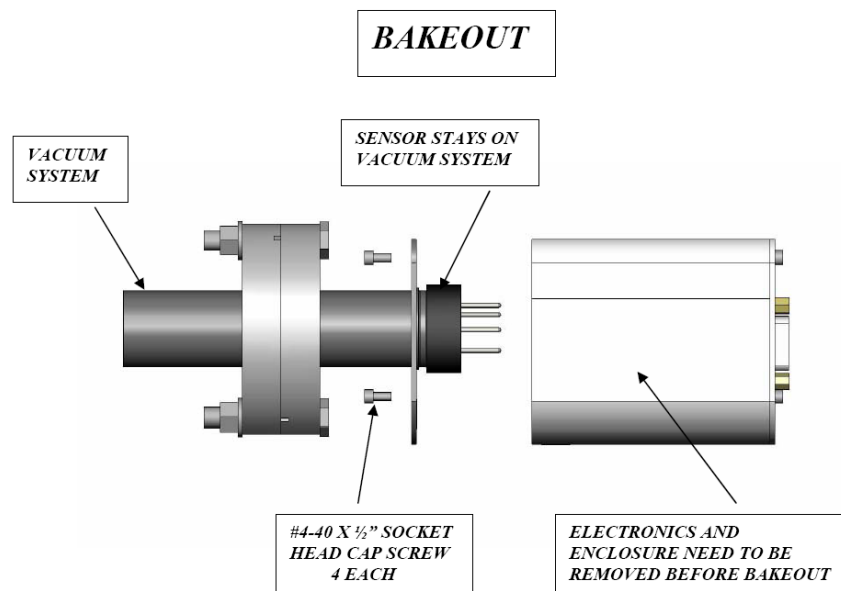

### 4.2 Bakeout - Convection vacuum gauges CG1 and CG2

The InstruTech Worker Bee convection vacuum gauges CG1 and CG2 can be baked out to 150 °C. The CG1 and CG2 connectors and cables must be removed prior to bake out.

## 5 Setup and Operation

### 5.1 Applying power

Connect power to IGM402 using the designated pins 4 and 2 of either the 9-pin, D-sub, **ANALOG** or the 9-pin, D-sub, **RS485 COM** connector. Do not connect power to both connectors simultaneously.

**CAUTION!** The +24 Vdc Power and Power Ground pin-out connections **are not the same** on the ANALOG and RS485 COM 9-pin D-subminiature connectors of the IGM402. Equipment damage may result if a mating power/control cable is not wired for the correct power and ground connections. Be certain that you observe the correct pin-out designation for the connector on the IGM402 that you intend to connect to.

Alternatively, you can power the device by connecting InstruTech’s PS501-A power supply to the ANALOG connector of the IGM402. When you connect power, the display will show “UNIT STATUS OFF”. This indicates the display is on but the filament is not turned on and the sensor has not been activated yet. Read this user manual in its entirety before activating the sensor. Refer to [section 5.9](#) titled “Activating the sensor” for further details.

### 5.2 Emission Current

4 mA or 100 µA (0.1 mA) emission current are available settings of emission current.

- 1) In clean applications and operating at higher pressure ranges ( $5.00 \times 10^{-6}$  Torr to  $5.00 \times 10^{-2}$  Torr) the 100 µA emission current setting is preferred.
- 2) At lower operating pressures ( $1.00 \times 10^{-9}$  Torr to  $5.00 \times 10^{-4}$  Torr) the 4 mA emission current setting should be used.
- 3) When using a diffusion pump or other pumps that use fluids, there is a possibility of the pump oil vapors entering the IG transducer. These vapors may form an insulator on the internal components of the transducer which can lead to instability or failure in controlling the emission. In this case, the 4 mA emission current may provide improved operating lifetime and measurement performance.

### 5.3 Overpressure shut down

The IGM402 is provided with factory set default values for overpressure shut down. The gauge will shut off automatically should the pressure reach or rise above the pressure shut down values shown below:

**Factory set overpressure shut down values**

Emission Current	Overpressure Shut Down (Torr)	Overpressure Shut Down (mbar)	Overpressure Shut Down (Pa)
4 mA	$1.00 \times 10^{-3}$	$1.33 \times 10^{-3}$	$1.33 \times 10^{-1}$
100 µA (0.1 mA)	$5.00 \times 10^{-2}$	$6.66 \times 10^{-2}$	6.66

## 5.4 Degas

Degas is used to rid the gauge sensor of adsorbed gas. Degas is achieved by applying Electron Bombardment (EB) to the grid. The intervals at which degas should be applied vary for each application. The low pressure measurement performance of the transducer will normally improve after each degassing cycle.

- Degas can only be applied while the filament is turned on and operating.
- Ensure vacuum level is at or less than  $5.00 \times 10^{-5}$  Torr before attempting to initiate degas.
- Power during degas is about 3 watts higher than the normal operating power.
- Degas will automatically turn off after 2 minutes when using factory default settings. Degas can be programmed for duration of 2 to 10 minutes.
- The IGM402 will continue to measure pressure while degas is in progress.
- Degas will automatically turn off if the pressure exceeds  $3.00 \times 10^{-4}$  Torr during the degas cycle.
- Degas can be interrupted by turning the IGM402 filament off.

## 5.5 Filament Material Selection / Venting the Chamber

The choice of which filament to use in the IGM402 is primarily dependent upon the process and process gases the ion gauge will be used with. For general vacuum applications, dual yttria coated filaments are offered for use with air and inert gases such as  $N_2$ , argon, etc. Optional dual tungsten filaments are available for use with gases not compatible with yttria filaments.

### 1) Yttria coated iridium filament

In most general vacuum applications, the yttria coated iridium filament is the best choice.

Yttria filaments typically operate at a lower temperature than tungsten filaments and thus have a lower outgassing rate at UHV and lower chemical reactivity with active gases.

Yttria filaments typically have a longer operating life than Tungsten filaments in clean applications.

The yttria coated filament can survive occasional accidental start attempts at atmosphere in air, but the overall life of the filament may be shortened during each occurrence. Good vacuum practice is to use the CVG101 *Worker Bee™* convection gauge (CG1) to know when to turn on the ion gauge filament.

### 2) Tungsten filament

Typically a bare tungsten filament is a better choice in those applications where an yttria coated filament is quickly damaged due to the gas type in use. For example, processes such as ion implantation may use tungsten filaments. Be aware that corrosive applications are hard on any filament and filament life will be reduced when operating in such environments. Tungsten filaments are easily damaged by exposure to air/oxygen during

accidental system vents or if considerable quantities of water vapor are outgassed during pump-down and bake-out. It is very important to make sure the tungsten filament is turned off before bringing the chamber up to atmosphere, especially if air is being used to vent the chamber. The use of pure N<sub>2</sub> gas is highly recommended to vent or purge your vacuum chamber. Testing has shown that tungsten filaments can withstand limited high pressure excursions when only N<sub>2</sub> is present.

Venting with air or other oxygen containing gases can damage the tungsten filaments. If you try to turn on an ion gauge with tungsten filaments while it is sitting on your desk exposed to room air, you will immediately damage or destroy the filament beyond repair.

**NOTICE**

Do not use another gauge to automatically turn off the ion gauge when the ion gauge filament in use is constructed of tungsten (yttria coated filament is ok). The response time of other gauges may not allow for timely turn off of the tungsten filament leading to filament damage. Always turn off the IG filament manually before pressure is to rise above  $1.00 \times 10^{-3}$  Torr.

**Note** - Both types of filaments will suffer eventual damage if operated at high pressures. The type and amount of damage at high pressure is dependent upon the length of operating time, the pressure and the gas present.

## 5.6 User Interface Basics

The user interface is designed for easy operation and a natural progression of setup parameters and control functions. This section gives a brief explanation of device operation for added clarity.

There are four soft-keys located on the front panel, below the display. These keys are used to select and program the various parameters and control functions available. During programming of the IGM402, the display will identify what each function key represents.

To begin programming, press the MENU key. Press either the UP or DOWN key to choose (highlight) the desired menu. Press the ENTER key to access the menu choice, change parameters and save the new settings.

Press the MENU key to return to the previous menu or, if necessary, press repeatedly to return to the main pressure measurement display screen. To continue setting additional parameters, scroll with the UP and DOWN keys until you reach the desired parameter.



Programming soft-keys

## 5.7 Factory-Set Default Parameters

The following is a summary of all **factory-set default** values in the IGM402 Top Level Program Menu.

### SETUP DISP

- SET CONTRAST [Factory default = 10]
- SHOW DATA [Factory default = *SHOW ALL LG*]
- DISPLAY INT [Factory default = 3 *SECONDS*]
- FLIP SCREEN [Factory default = *NORMAL*]

### SETUP UNIT

- UNITS [Factory default = *TORR*]
- DEFAULTS [Factory default = *MENU TO EXIT*]
- CLR IG ERROR [Factory default = *OFF*]
- 100UA TRN ON [Factory default = *5.00E-02 TORR*]
- IG CNTL [Factory default = *DIGI/RS485*, (Factory default is *DIGI* or Digital Input, see requirement for switching from *DIGI* to *RS485* mode at the [DIGI/RS485 section](#), below)] **If IG CNTL is set to *FRONT PANEL*, the Top Level Program Menu shown here will be modified; See [section 5.8.2., -FRONT PANEL](#), for the modified Top-Level Program Menu choices when IG CNTL is set for *FRONT PANEL*.**

### SETUP IG

- DEGAS TIME [Factory default = 2]
- SENSITIVITY [Factory default = *Actual Sensor sensitivity (see label on gauge)*]
- FILAMENT NUM [Factory default = *FILAMENT 1*]
- RLY I LO TRP [Factory default = *1.00E-06 TORR*]
- RLY I HI TRP [Factory default = *5.00E-06 TORR*]
- RELAY I TEST [Factory default = *OFF*]
- ANALOG MODE [Factory default = *IG ONLY*]
- FIL USAGE [Factory default = Displays to-date filament usage]

### SETUP CGS

- RLY A LO TRP [Factory default = *1.00E-1 TORR*]
- RLY A HI TRP [Factory default = *2.00E-1 TORR*]
- RELAY A TEST [Factory default = *OFF*]
- RLY B LO TRP [Factory default = *1.00E-1 TORR*]
- RLY B HI TRP [Factory default = *2.00E-1 TORR*]
- RELAY B TEST [Factory default = *OFF*]
- ASSIGN RLY A [Factory default = *CG1*]
- ASSIGN RLY B [Factory default = *CG2*]



**SETUP CGS** (*continued*)

- SETUP CG 1 [Press Enter key here to see the following choices]
  - SET VAC [Factory default =  $0.00E+0$  TORR]
  - SET ATM [Factory default =  $7.59E+2$  TORR]
  - ANALOG TYPE [Factory default = LOG-LINEAR]
  
- SETUP CG 2 [Press Enter key here to see the following choices]
  - SET VAC [Factory default =  $0.00E+0$  TORR]
  - SET ATM [Factory default =  $7.59E+2$  TORR]
  - ANALOG TYPE [Factory default = LOG-LINEAR]

**SETUP COMMS**

- BAUD RATE [Factory default = 19200, 8, N, 1]
- ADDR [Factory default = 1]
- ADDR OFFSET [Factory default = 0]
- FORMAT [Factory default = BINARY]

**SERVICE MENU**

- INFO [Factory default = FIRMWARE VERSION]
- OP TIME [Factory default = Displays to-date operating time]

## 5.8 Programming

This section provides detailed information on programming and configuration of the various menus and submenus of the device. The main, top-level menu choices shown starting at [section 5.8.1 SETUP DISP](#) (setup display) are what will be displayed when factory defaults are set. If you set **IG CNTL** (ion gauge control) to **FRONT PANEL**, the top-level menu choices change to include easy access for control of **IG ON**, **IG OFF**, **EMISSION SEL**, **DEGAS ON** and **DEGAS OFF**. The main, top-level programming screen is arrived at by pressing the **MENU** key one or more times. If you intend to operate the IGM402 using **FRONT PANEL** control, please see [Top-Level Program Menu when FRONT PANEL is selected for IG CNTL](#) in the **SETUP UNIT** [section 5.8.2](#) below for the ordered list of available choices when in the top-level menu.

Follow the key entry sequences of **MENU** ⇒ **↑** ⇒ or **↓** ⇒ and, finally, **ENTER** ⇒ where the symbol ⇒ represents the act of pressing the appropriate front panel soft-key. Please note that changes to various control functions will not take effect until the selected choice is entered by pressing the **ENTER** key at the desired menu choice and, in some cases, the **MENU** key is pressed to return to the main pressure display screen. In some cases, the **ENTER** key must be pressed multiple times to scroll the cursor (highlighted character) across the displayed menu item until the last character of the displayed line is entered. For example, when changing the value of a setpoint pressure (ON or OFF) for the setpoint relays or when adjusting the VAC (zero) or ATM (span) reading for the CG vacuum and atmospheric pressure indications, note that the highlight cursor will wrap around the menu choices if either one of the **↑** or the **↓** keys are pressed repeatedly.



The menu structure may be visualized as a cascading list of choices navigated to and selected by pressing either the **↑** or the **↓** and **ENTER** keys. An example of navigating to a particular menu choice is given by:

The display is showing the pressure (vacuum) being measured. By pressing the **MENU** key the display will show the top-level menu choices (as shown in the leftmost, bold print menu choices listed in [section 5.7](#), above). If you choose to control the IG using the front panel control mode, then the sequence of key entries is **MENU** ⇒ **↑** ⇒ or **↓** ⇒ until **SETUP UNIT** is highlighted then, **ENTER** ⇒ and, **↑** ⇒ or **↓** ⇒ until **IG CNTL** is highlighted then, **ENTER** ⇒ and, **↑** ⇒ or **↓** ⇒ until **FRONT PANEL** is displayed then, **ENTER** ⇒. The display should now revert back to the main pressure display. Now, if you press the **MENU** key after setting up front panel IG control, you will see the revised top-level menu with the additional choices of **IG ON**, **IG OFF**, **EMISSION SEL**, **DEGAS ON** and **DEGAS OFF** listed as:

- **IG ON**
- **IG OFF**
- **SETUP DISP**
- **SETUP UNIT**
- **SETUP IG**
- **SETUP CGS**
- **SETUP COMMS**
- **SERVICE MENU**
- **EMISSION SEL**
- **DEGAS OFF**
- **DEGAS ON**

If you have performed the operations as described in the example above to set the IGM402 to **FRONT PANEL** under the **SETUP UNIT** ⇒ **IG CNTL** ⇒ **FRONT PANEL** program menu sequence, refer to the detailed explanation of each of the program choices shown here, at the left, in the following sections. Quick reference to the augmented top-level, main menu is found at [Top-Level Program Menu... in section 5.8.2](#)

5.8.1 **SETUP DISP**

The following submenu choices allow you to setup the display (DISP) to show the format you desire. These will be shown on the front panel display when you press the ENTER key when SETUP DISP is highlighted. Scroll to the menu of choice by using either the  or  keys.

- **SET CONTRAST** [Factory default = 10]

This function sets the display contrast. Use the ENTER key to access the CONTRAST menu and use the UP and DOWN keys to select a number between 1 and 120. The contrast setting of 120 provides the highest contrast (brightest) and 1 the lowest. Select the ENTER key again to save the value selected.

**Note** - Factory default setting optimizes display life.

- **SHOW DATA** [Factory default = SHOW ALL LG]

Use the ENTER key to access the SHOW DATA menu and use the UP and DOWN keys to select one of the following display modes:

<i>SHOW ALL LG</i>	<i>SHOW ALL SM</i>	<i>IG + CG1 LG</i>	<i>IG+CG1/CG2</i>
<i>IG/CG1 LG</i>	<i>IG/CG2 LG</i>	<i>CG1/CG2 LG</i>	<i>CG1/CG2 SM</i>
<i>IG ONLY</i>	<i>IG ONLY RND</i>	<i>CG1 ONLY</i>	<i>CG2 ONLY</i>

Select the ENTER key again to save the desired mode selected above.

- **SHOW ALL LG**

This mode displays measured pressure, the pressure unit, the gas symbol, and filament and relay status from the ionization gauge, the CG1 and CG2 convection vacuum gauges in three separate screens. The three screens are displayed sequentially and repeatedly showing the ion gauge data first, followed next by screens for CG1 and CG2. In the following examples, the measured pressure from the ion gauge is 6.45E-9 Torr, filament #1 is on, gas is nitrogen and Relay I is energized.

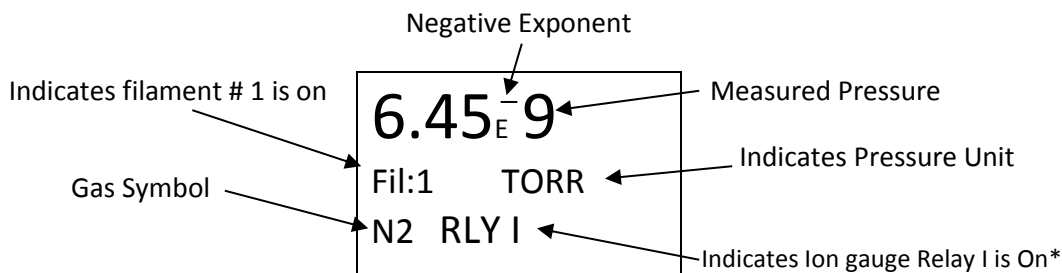

**Ex 1A: Ionization Gauge data displayed in SHOW ALL LG mode**

The ionization gauge display screen (Example Ex 1A) above is followed by the next screen below showing the convection gauge 1 (CG1) data after the display interval time has elapsed.

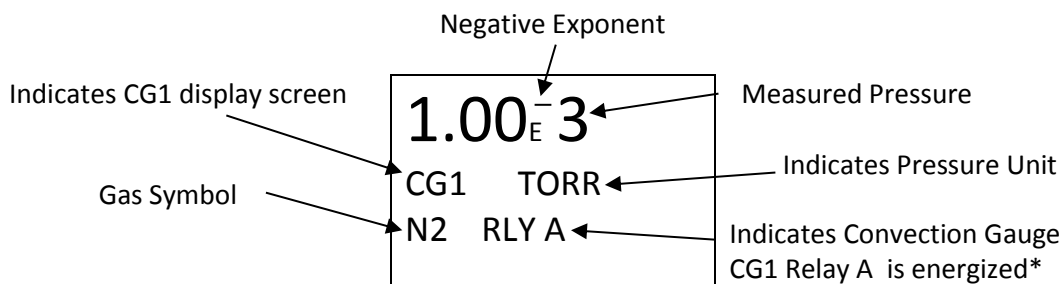

**Ex 1B: CG1 data displayed in *SHOW ALL LG* mode**

The convection gauge 1 data screen (Example Ex 1B) above is followed by the next screen below showing the convection gauge 2 (CG2) data after the display interval time has elapsed.

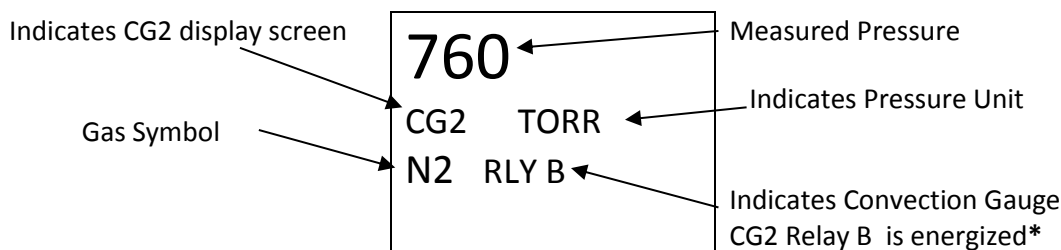

**Ex 1C: CG2 data displayed in *SHOW ALL LG* mode**

**\*Note** - RLY I, A & B disappears from the display when the relay is not energized (relay is turned off).

**- *SHOW ALL SM***

This mode displays the measured pressure from the ionization gauge, CG1 and CG2 convection gauges simultaneously in one screen. In the following example, the measured pressure from the ionization gauge (IG) is 6.45E-9 Torr, the measured pressure from convection gauge 1 (CG1) is 1.23E-2 Torr and measured pressure from convection gauge 2 (CG2) is 760 Torr.

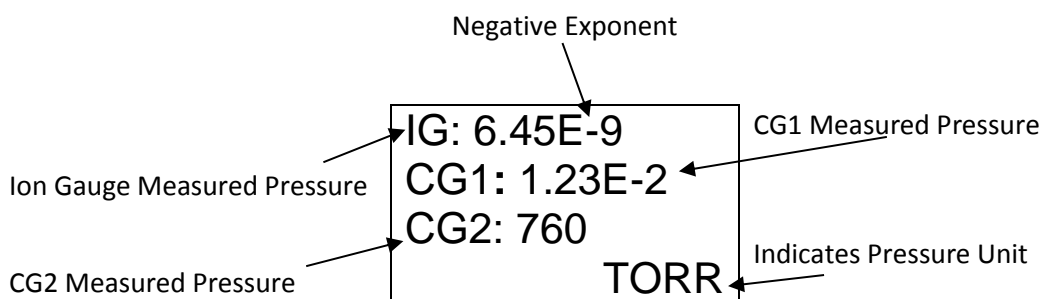

**Ex 2A: IG, CG1 and CG2 data displayed in *SHOW ALL SM* mode**

**- IG + CG1 LG**

This mode shows the combined vacuum measurements of the ion gauge and convection gauge 1 (CG1) on one display line, providing wide range vacuum measurements of your chamber from  $1.00 \times 10^{-9}$  to 1,000 Torr. This combination measurement function is available only with CG1. **Note** - If you are using the analog output signal and need it in the same combination mode as described for the display above, you must also access the SETUP IG Menu, then select ANALOG MODE, then select IG + CG1 and save.

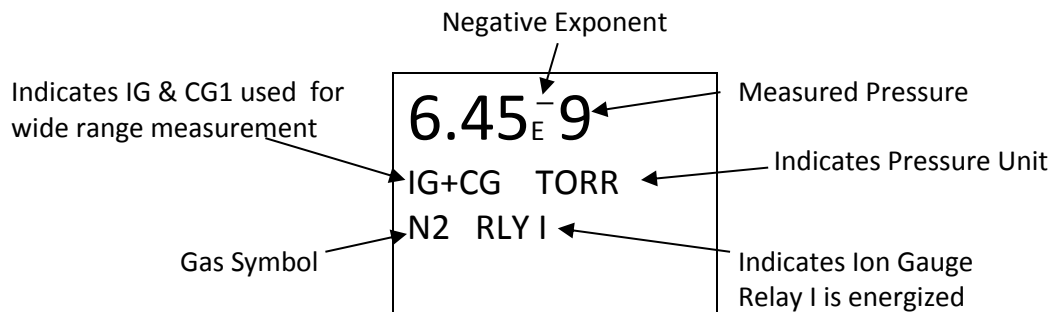
**Ex 3A: IG + CG1 data displayed for wide range vacuum measurements with CG1 in IG + CG1 LG mode**

**Note** - In this mode any pressures displayed from 1.00E-9 to 1.00E-3 Torr are based on measurements from the ion gauge. Displayed pressures higher than 1.00E-3 Torr are based on measurements from CG1.

**Note** - When selecting *IG + CG1 LG* or the *IG + CG1/CG2*, the analog output in the ANALOG MODE of the SETUP IG menu must also be set to *IG + CG1*. This will enable the analog output to provide a log-linear 0.5 to 7 Vdc, 0.5 V/decade over the entire wide range measurement. (See SET UP IG and ANALOG MODE in [Section 5.8.3](#))

**- IG + CG1/CG2**

In this mode two separate display screens appear sequentially. The first screen combines the vacuum measurement from the ion gauge and convection gauge 1 (CG1) to provide wide range vacuum measurements from  $1 \times 10^{-9}$  to atmosphere as shown in example Ex 3A. (**Note** - This wide range measurement function is available only with CG1). This is followed by the second screen showing the convection gauge 2 (CG2) data as shown in example Ex 1C. The screens repeat each time the programmed display interval time has elapsed.

**- IG/CG1 LG**

In this mode two separate display screens appear sequentially. The first screen shows the ionization gauge data as shown in Example Ex 1A. This is followed by the second screen showing the convection gauge 1 (CG1) data as shown in Example Ex 1B. The screens repeat each time the programmed display interval time has elapsed. The convection gauge 2 (CG2) data is not displayed.

**- IG/CG2 LG**

In this mode two separate display screens appear sequentially. The first screen shows the ionization gauge data as shown in Example Ex 1A. This is followed by the second screen showing the convection gauge 2 (CG2) data as shown in Example Ex 1C. The screens repeat each time the programmed display interval time has elapsed. The convection gauge 1 (CG1) data is not displayed.

**- CG1/CG2 LG**

In this mode two separate display screens appear sequentially. The first screen shows the convection gauge 1 (CG1) data as shown in Example Ex 1B. This is followed by the second screen showing the convection gauge 2 (CG2) data as shown in Example Ex 1C. The screens repeat each time the programmed display interval time has elapsed. The ionization gauge (IG) data is not displayed.

**- CG1/CG2 SM**

This mode displays the measured pressure from the CG1 and CG2 convection gauges simultaneously in one screen as shown in the example below:

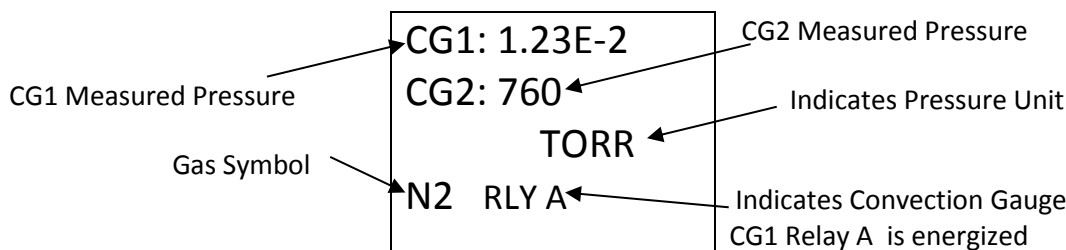

**Ex 8A: CG1 and CG2 data displayed in CG1/CG2 SM mode**

**- IG ONLY**

This mode displays only the measured pressure from the ionization gauge in a single screen as shown in Example Ex 1A.

**- IG ONLY RND**

This mode displays the measured pressure, emission current, ion current, filament voltage and filament current. In the following example, the measured pressure is 1.00E-9 Torr, (Pressure unit is based on selected units in SETUP UNIT menu). Emission current is 4.00E-3 amperes, Ion current is 4.00E-11 amperes, filament voltage is 1.5 Vdc and filament current is 1.9 amperes.

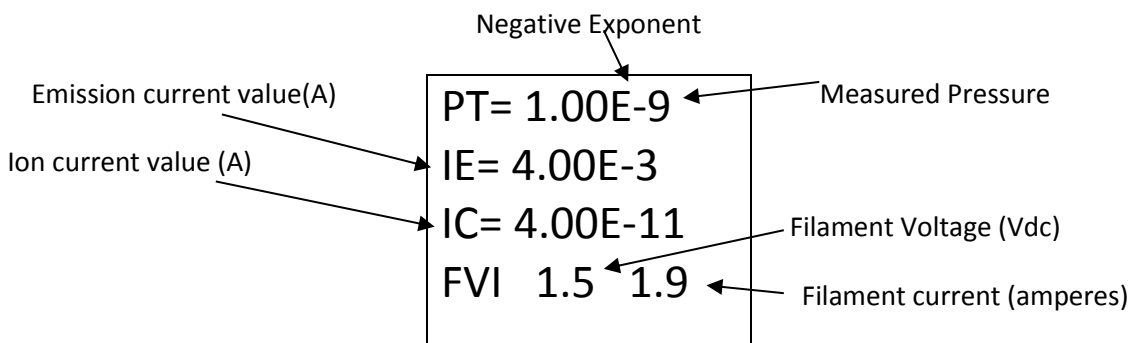

**Ex 10A: IG data displayed in IG ONLY RND mode**

**- CG1 ONLY**

This mode displays only the measured pressure from convection gauge 1 (CG1) in a single screen as shown in Example Ex 1B.

**- CG2 ONLY**

This mode displays only the measured pressure from convection gauge 2 (CG2) in a single screen as shown in example Ex 1C.

**- DISPLAY INT** [Factory default =3 SECONDS]

This is the time it takes for display screen to change to the next screen. Display interval can be selected from 2 to 10 seconds.

**- FLIP SCREEN** [Factory default = NORMAL]

This allows the user to select a *NORMAL* display or have the pressure measurement data displayed upside down. When the IGM402 is mounted upside down, this selection is used to invert the display screen 180 degrees for user convenience. **Note** - When UPSIDE DOWN is selected, the user has to save the setting and exit the menu before the measured values are displayed.

**5.8.2 SETUP UNIT****- UNITS** [Factory default = TORR]

Select from TORR, mBAR or PASCAL. Units selected are used for all other settings.

**- DEFAULTS** [Factory default =MENU TO EXIT]

The module can be returned to the original factory settings by using the ENTER key to set factory defaults.

**Note** - If you set factory defaults, you must re-enter the actual IG sensor SENSITIVITY value marked on the IG sensor, set atmosphere and zero for both CG1 and CG2, and reprogram other parameters as required.

**- CLR IG ERROR** [Factory default = OFF]

When the IGM402 ionization gauge (IG) experiences an error condition such as OVERPRESSURE, emission failure, etc., the Ion gauge filament will turn off and the module will stop measuring pressure. Error messages will be displayed on the IGM402 screen showing the error. This is intended to prompt the user to determine what the error condition is before the filament can be turned on again. Once the cause of the error has been determined and resolved, the error must be cleared before the filament can be turned on again. The CLR IG ERROR allows the user to clear the IG error using the front panel soft-keys, regardless of whether the IG CNTL mode below is set to Front Panel, Digital Input or RS485.

**- 100UA TRN ON** [Factory default = 5.00E-02 TORR]

This allows the user to select a pressure value as measured by CG1 at which the IG filament can be turned on. This is applicable only when the gauge is operating at 100  $\mu$ A emission current setting and the IG CNTL mode below is set to CG1 CONT IG. When operating with the 100  $\mu$ A emission current setting, the 100UA TRN ON pressure value can never be set higher than  $5.00 \times 10^{-2}$  Torr.

**Note** - The user does not have the choice to select a turn on/off point to automatically switch the IG filament state when the emission current selected is 4 mA. The IG filament turn off is always set to  $1.00 \times 10^{-3}$  Torr when the emission current setting is 4 mA. When the 4 mA emission current setting is selected the pressure must be at  $1.00 \times 10^{-3}$  Torr or less before the IG filament can be turned on.

**- IG CNTL** [Factory default = DIGI/RS485]

This allows the user to choose the source of control for the IG. The IG can be controlled via digital inputs, RS485 commands, front panel soft-keys or convection gauge CG1.

**➤ DIGI/RS485**

The DIGI/RS485 control selection allows the application of either digital inputs or RS485 serial interface commands to operate the IGM402. The default state of the DIGI/RS485 selection is digital input (*DIGI*). This control mode requires grounding pin 1 of the 9-pin D-sub male (DE-9P) ANALOG connector to turn the IG filament to ON and activate the sensor.

The user should verify the *DIGI/RS485* is selected in the IG CNTL submenu of the SETUP UNIT menu. When operating in the Digital Input (*DIGI*) mode, the IG filament can only be turned on by continuously connecting circuit ground (pin 2) to pin 1 of the DE-9P ANALOG connector. Degas and emission current selection can also be set using the digital inputs available on the DE-9P ANALOG connector. Connect the ANALOG connector pins 2 and 8 together to change from an emission current of 100  $\mu$ A to 4 mA. See [section 3.3.2.1](#), ANALOG connector pin-out for details related to Digital I/O connections. Connecting ANALOG connector contact pin 6 to pin 2 will assert DEGAS when the IG filament is in the ON state. An external control device like a PLC may be used to set pin 1 to ground (circuit common) as long as the PLC circuit common (ground) is tied to the IGM402 ANALOG connector pin 2.

To change from DIGI to RS485 communication mode, use the 9-pin RS485 D-sub female (DE-9S) connector to connect the DATA A (-) and DATA B (+) RS485 signal lines. The user should verify DIGI/RS485 is selected in the *IG CNTL* submenu of the SETUP UNIT menu.

In order for the IGM402 to operate in the in the RS485 mode, the user must send a command to turn the IG to OFF. If you have already turned the IG ON in the default DIGI mode and you send the IG OFF command via RS485 to auto switch from DIGI to RS485 mode, the IG will turn OFF. If the RS485 command to turn IG ON is sent, then the IG will stay in the ON state and the control mode will be auto switched to RS485.

The program code control logic is such that when switching from DIGI controls to RS485 controls, the device will invoke a 'safe state' if any RS485 command is sent to switch from DIGI to RS485. A command sent to the IGM402 such as IG ON/OFF, DEGAS ON/OFF or SET ION GAUGE EMISSION CURRENT will cause the IGM402 to automatically switch from the DIGI mode to the RS485 control mode. Sending **READ** commands such as read gauge pressure will not accomplish this task. When operating in the RS485 mode, all other inputs are ignored (i.e., the host has control).

**Note** - To change from the RS485 to another IG CNTL mode, the RESET command must be sent to the IGM402 or power to the IGM402 must be turned off and on. This will reset IG CNTL to *DIGI /RS485* factory default setting with the default state of this selection being the digital input (*DIGI*) again.



➤ **FRONT PANEL**

This mode of operation allows the user to manually turn the IG filament on/off, select emission current and turn degas on/off using the front panel soft-keys. This is achieved by selecting FRONT PANEL in the IG CNTL submenu of the SETUP UNIT menu. In this case the FRONT PANEL overrides any other input and the *DIGI/RS485* inputs are ignored. If FRONT PANEL is selected, the following Top-Level Program Menu will be displayed after the MENU key is pressed. Compare the following program selection menu to the selection choices shown at [section 5.7](#) for default program parameters and settings.

**- Top-Level Program Menu when FRONT PANEL is selected for IG CNTL:**

IG ON <sup>(A)</sup>  
 IG OFF <sup>(A)</sup>  
 SETUP DISPLAY  
 SETUP UNIT  
 SETUP IG  
 SETUP CGS  
 SETUP COMMS  
 SERVICE MENU  
 EMISSION SEL <sup>(B)</sup>  
 DEGAS OFF <sup>(C)</sup>  
 DEGAS ON <sup>(C)</sup>

<sup>(A)</sup>**IG ON/OFF** [Factory default = OFF] If the IG is in the default OFF state, select the IG ON line in the displayed menu and then press ENTER to turn the IG ON. The device will respond immediately to either entry of IG ON or IG OFF when selected and ENTER is pressed.

<sup>(B)</sup>**EMISSION SEL** [Factory default =100UA] Access setting to change emission current to 4 mA or 100  $\mu$ A.

<sup>(C)</sup>**DEGAS ON/OFF** [Factory default = OFF] Access setting to turn degas on or off. Degas operation may be invoked immediately when the IG filament is in the ON state by pressing the ENTER key after selecting DEGAS ON in the main TOP-LEVEL Program Menu. The device will respond immediately after the ENTER key is pressed for either DEGAS ON or DEGAS OFF.

➤ **CG1 CONT IG**

This allows the use of the pressure measurement from CG1 to automatically turn the selected filament on and off. **Pin 1 of the ANALOG connector must be connected to Pin 2 of the ANALOG connector and emission current must be set to 100  $\mu$ A for this function to work. To operate the IG at an emission current of 4 mA, see '2)' below. The filament will be turned on at the 100UA TRN ON setting when in the CG1 CONT IG mode.** The on/off control of the IG filament using the pressure measured by CG1 can be set under two different scenarios:

- 1) If the ion gauge emission current is set to 100  $\mu$ A, the ion gauge filament will turn on when the pressure measured from CG1 drops below the value programmed in the 100UA TRN ON submenu of the SETUP

*UNIT* menu. The ion gauge filament will turn off when the pressure measured from CG1 rises above the pressure value programmed for the *100UA TRN ON* setting.

- 2) If the ion gauge emission current is set to 4 mA, the ion gauge filament will turn on when the pressure measured from CG1 drops below  $1.00 \times 10^{-3}$  Torr. The ion gauge filament will turn off when the pressure measured from CG1 rises above  $1.00 \times 10^{-3}$  Torr.

**Note** - To turn the IG filament off manually when *CG1 CONT IG* is selected, pin 1 of the ANALOG connector must be disconnected from pin 2 of the same connector. This is the case only when filament turn off is required before the pressure measured by CG1 rises above the maximum of  $5.00 \times 10^{-2}$  Torr for the 100  $\mu$ A emission current setting and  $1.00 \times 10^{-3}$  Torr for the 4 mA emission current setting. It is highly recommended that PIN 1 of the Analog connector is wired in such a way that it can be connected to pin 2 of the Analog connector, but that connection can be opened to manually turn off the IG. This will allow the user to override the CG turning on the IG. **Use of a manual switch which can be easily accessed by the user should be considered.** The IG will only turn OFF when the connection between pins 1 and 2 of the ANALOG connector is open circuit and the main pressure display screen is active. If the display screen is in one of the programming menus the manual switch is ignored and the IG will not turn OFF even if the switch between pins 1 and 2 is open circuit.

When *CG1 CONT IG* is selected, the **emission current** and **degas** will operate using Digital Inputs as described in the previous section (- *IG CNTL, DIGI/RS485*) as defined by the ANALOG connector pin-out in [section 3.3.2.1](#). For example, the default emission current setting for the IG when in the *CG1 CONT IG* mode of operation is 100  $\mu$ A. If it is desired to operate the IG with an emission current of 4 mA, then it will be necessary to provide capability to switch the emission current select pin (ANALOG connector contact 8) to power ground (circuit common) available at pin 2 of the ANALOG (DE-9P) connector of the IGM402 while operating in the *CG1 CNTL IG* control mode.

### 5.8.3 SETUP IG

- **DEGAS TIME** [Factory default = 2]

The length of time in minutes that degassing will operate after it is initiated. Degas cycle can be selected from 2 to 10 minutes.

- **SENSITIVITY** [Factory default = Actual Sensor Sensitivity (nominal = 8 to 15 torr<sup>-1</sup>)]

The actual sensitivity value of each ion gauge sensor is marked on the end plate below the electronic enclosure. The sensitivity value is designated with the letter "S" and it is a number that normally ranges between 8 and 15. The actual sensitivity value of the ion gauge sensor is programmed in the electronics at the factory prior to shipment. This value is also user adjustable between 2 to 99. Ion gauge pressure readings are calibrated for nitrogen. If you use a different gas species or mixture of gases other than nitrogen, you will be required to either make manual corrections to the pressure readout or compensate the reading. The sensitivity adjustment function of the IGM402 you are using to measure the pressure of a gas other than nitrogen/air may be set to compensate the reading. Compensating the pressure reading using the sensitivity adjustment method may not be possible for certain gases if the sensitivity correction factor results in a calculated sensitivity outside the adjustment range. **User assumes all risks if sensitivity is set to a value different than the actual sensor Sensitivity.**

- **FILAMENT NUM** [Factory default = FILAMENT 1]

Allows user to select which filament to operate: *Filament 1* or *Filament 2*

**Note - When using yttria coated filaments, it is highly recommended to periodically alternate operating Filaments 1 and 2. An inactive filament not operating for an extended length of time may result in that filament failing to establish emission current when it is eventually used, especially in dirty applications.**

- **RLY I LO TRP** [Factory default = 1.00E-06 TORR] TRP is the menu abbreviation for TRP or SETPOINT

The relay is energized when pressure measured by IG reaches this setpoint.

If RLY I LO TRP is programmed to a lower value than RLY I HI TRP, relay will energize when pressure drops below the RLY I LO TRP setting. Relay will then de-energize when pressure rises above RLY I HI TRP.

If RLY I LO TRP is programmed to a higher value than RLY I HI TRP, relay will energize when pressure rises above the RLY I LO TRP setting. Relay will then de-energize when pressure drops below RLY I HI TRP.

The range of adjustment for setpoint pressure is 1.00E-11 to 3.00E-02 Torr. Setting the setpoint pressure below 1.00E-09 Torr may not be useful since the device has a low end measurement capability of 1.00E-09 Torr.

**Note** - If you have an older version of IGM402 with firmware number 1769-107 or lower (See INFO submenu in SERVICE MENU screen) the RLY I LO TRP setpoint corresponds to the turn on point for the relay. The relay will turn on when the pressure drops below this setting. With this older version of the firmware you will not be able to set the RLY I LO TRP value higher than the RLY I HI TRP. If you try to set the RLY I LO TRP to a value higher than RLY I HI TRP, the IGM402 will revert back to the original RLY I LO TRP value. To do this correctly so that the IGM402 will accept the new setting for the RLY I LO TRP, you must first select the RLY I HI TRP listed below and increase that value to a number higher than the value of RLY I LO TRP you are trying to set.

- **RLY I HI TRP** [Factory default = 5.00E-06 TORR]

The relay is de-energized when pressure measured by IG reaches this setpoint.

If RLY I HI TRP is programmed to a higher value than RLY I LO TRP, relay will de-energize when pressure rises above the RLY I HI TRP setting. Relay will energize when pressure drops below RLY I LO TRP.

If RLY I HI TRP is programmed to a lower value than RLY I LO TRP, relay will de-energize when pressure drops below RLY I HI TRP setting. Relay will then energize when pressure rises above RLY I LO TRP.

The range of adjustment for setpoint pressure is 1.00E-11 to 3.00E-02 Torr. Setting the setpoint pressure below 1.00E-09 Torr may not be useful since the device has a low end measurement capability of 1.00E-09 Torr.

**Note** - If you have an older version of IGM402 with firmware number 1769-107 or lower (See INFO submenu in SERVICE MENU screen) the RLY I HI TRP setpoint corresponds to the turn off point for the relay. The relay will turn off when the pressure rises above this setting. With this older version of the firmware you will not be able to set the RLY I HI TRP value lower than the RLY I LO TRP. If you try to set the RLY I HI TRP to a value lower than RLY I LO TRP, the IGM402 will revert back to the original RLY I HI TRP value. To do this correctly

so that the IGM402 will accept the new setting for the RLY I HI TRP, you must first select the RLY I LO TRP listed above and decrease that value to a number lower than the value of RLY I HI TRP you are trying to set.

- **RELAY I TEST** [Factory default = OFF]

This allows the user to manually toggle the relay on and off to test for correct external circuit wiring and ensure polarity is as desired.

- **ANALOG MODE** [Factory default = IG ONLY]

This sets the analog output proportional to pressure measured from the ionization gauge or *IG + CG1* for wide range vacuum measurements.

Select analog output type as *IG ONLY* to set the analog output proportional to pressure measured from the ion gauge only (log-linear 0 to 9 Vdc, 1 V/decade).

Select analog output type as *IG + CG1* to set the analog output proportional to pressure if you intend to combine the measurements from the ion gauge and the CG1 convection gauge for wide range vacuum measurements (log-linear 0.5 to 7 Vdc, 0.5 V/decade).

- **FIL USAGE** [Factory default = all at zero]

This allows the user to view how many hours each filament has been turned on and how many hours degassing has been applied to each filament. The display in this screen provides the following data:

*F1: # H* (Number of hours filament 1 has been in use).

*F2: # H* (Number of hours filament 2 has been in use).

*D1: # H* (Number of hours filament 1 has been degassed).

*D2: # H* (Number of hours filament 2 has been degassed).

#### 5.8.4 SETUP CGS<sup>2</sup>

[See [section 3.3.2.3](#) for detail related to CG1, CG2, and RLY A and RLY B wiring connections]

- **RLY A LO TRP** [Factory default = 1.00 -1 TORR] TRP is the menu abbreviation for TRIP or SETPOINT

This setpoint corresponds to the turn on point for the CG1 relay. The relay will turn on when the pressure measured from CG1 drops below this setting. **Note** - When using the front panel selection keys, if you try to set the RLY A LO TRP point to a value higher than RLY A HI TRP value, the IGM402 will revert back to the original RLY A LO TRP value. To do this correctly so that the IGM402 will accept the new setting for the RLY A LO TRP, you must first select the RLY A HI TRP (listed below) and increase that value to a number higher than the value of RLY A LO TRP you are trying to set. The lowest setpoint pressure value that you may set is 1.0E-03 Torr. The maximum setpoint pressure allowed is 1000 Torr.



- **RLY A HI TRP** [Factory default = 2.00E-1 TORR]

This setpoint corresponds to the turn off point for the CG1 relay. The relay will turn off when the pressure measured from CG1 risers above this setting. **Note** - When using the front panel selection keys, if you try to

<sup>2</sup> In the SETUP CGS descriptive narrative of this section 5.8.4., the default settings are assumed, where RLY A is assigned to CG1 and RLY B is assigned to CG2. See ASSIGN RLY A/B instructions related to changing the assignment of either relay A/B to either CG1/CG2.

set the RLY A HI TRP point to a value lower than RLY A LO TRP value, the IGM402 will revert back to the original RLY A HI TRP value. To do this correctly so that the IGM402 will accept the new setting for the RLY A HI TRP, you must first select the RLY A LO TRP listed above and decrease that value to a number lower than the value of RLY A HI TRP you are trying to set. The lowest setpoint pressure value that you may set is 1.0E-03 Torr. The maximum setpoint pressure allowed is 1000 Torr.

- **RELAY A TEST** [Factory default = OFF]

This allows the user to manually toggle the relay on and off to test for correct external circuit wiring and ensure polarity is as desired. If relay is energized due to assigned CG pressure reading being below the RLY A LO TRP setpoint, it may be cycled from ON to OFF by pressing the  and  keys when using this function .



- **RLY B LO TRP** [Factory default = 1.00E-1 TORR]

This setpoint corresponds to the turn on point for the CG2 relay. The relay will turn ON when the pressure measured from the CG2 drops below this setting. Use same setting guidelines stated above for RLY A LO TRP.

- **RLY B HI TRP** [Factory default = 2.00E-1 TORR]

This setpoint corresponds to the turn off point for the CG2 relay. The relay will turn OFF when the pressure measured from the CG2 rises above this setting. Use same setting guidelines stated above for RLY A HI TRP.

- **RELAY B TEST** [Factory default = OFF]

This allows the user to manually toggle the relay on and off to test for correct external circuit wiring and ensure polarity is as desired. If relay is energized due to assigned CG pressure reading being below the RLY B LO TRP setpoint, it may be cycled from ON to OFF by pressing the  and  keys when using this function .

- **ASSIGN RLY A** [Factory default = CG1]

This assigns Relay A to either the CG1 or CG2. The user also has the choice of assigning both relays A & B to one convection gauge.

- **ASSIGN RLY B** [Factory default = CG2]

This assigns Relay B to either the CG1 or CG2. The user also has the choice of assigning both relays A & B to one convection gauge.

#### 5.8.4.1 SETUP CG1

Two of the most important steps for the initial setup for the convection gauges are to set zero (*SET VAC*) and set atmosphere (*SET ATM*) as described below. This will ensure proper operation of the gauge and accurate pressure measurements. The gauge is calibrated at the factory using nitrogen. Furthermore, the gauge is also installed in a certain orientation when calibrated at the factory. Without setting zero and atmosphere after the gauge is installed in your system, the gauge may not display the expected and correct pressures. This could be caused by the fact that you may be using a different gas than Nitrogen such as air to setup and calibrate the gauge (most commonly the case) and the gauge orientation is different than the orientation used at the factory. As such, it is very important to perform your own initial setup and calibration by setting zero and atmosphere for the convection gauges installed in your actual system. Please note the following:

**Setting zero (*SET VAC*):** Setting zero optimizes performance of the gauge when operating at a low pressure range of  $1.00 \times 10^{-4}$  Torr to  $1.00 \times 10^{-3}$  Torr. If your minimum operating pressure is higher than  $1.00 \times 10^{-3}$  Torr, it is not normally necessary to set zero and thus setting atmosphere should be adequate. If you are able to evacuate your system to below  $1.00 \times 10^{-4}$  Torr, it is always a good practice to check and set zero if necessary. See "*SET VAC*" below.

**Setting Atmosphere (*SET ATM*):** Setting atmosphere is the most important step for a newly installed gauge. If you prefer to use air to set atmosphere, vent your vacuum system chamber to expose the gauge to the local atmospheric pressure (air) and set atmosphere to match your known local uncorrected barometric pressure (air). This is the reading of ambient air pressure you will expect if you were to vent and open your vacuum chamber to the atmosphere surrounding the outside of your chamber. At sea level, this pressure is usually near 760 Torr. At elevations above sea level, the pressure decreases. Check your local aviation authority or airport web sites or your current local weather conditions online to help find your local uncorrected barometric pressure if you do not have this information. See "*SET ATM*" below.

**Note** - Setting zero and atmosphere is normally required only once during the initial setup and maybe checked by the user periodically. After power has been applied to the gauge during the initial setup, allow five minutes for the gauge to stabilize (warm-up) before setting zero and atmosphere.

**NOTICE**

When operating in units of either mbar or pascals (Pa), you must perform SET ATM before setting the vacuum reading (SET VACUUM). See SET ATM below. Failure to do so will result in improper operation of the gauge. If you change units of measure or reset to factory defaults, then this same procedure must be followed again if the units of measure are being set to either mbar or Pa.

Pressing the ENTER key will display the following three settings for CG1:

- SET VAC
- SET ATM
- ANALOG TYPE

**- SET VAC**

InstruTech advises that you **first** determine if the 'span' (ATM) adjustment of your measurement device is set properly **before** setting the 'zero' (VAC) adjustment. It is good practice to perform the sequence of checking and adjusting ATM (span) then VAC (zero) and then, finally re-checking the ATM setting to ensure the instrument has been properly set.

Setting the Zero Point for CG1 (vacuum adjustment):

1. To properly set the vacuum reading ("zero" point), with CG1 installed on your vacuum system, the gauge should be evacuated to a pressure below  $1.00 \times 10^{-4}$  Torr. [Factory default = 0.00E+0 Torr]
2. When the known vacuum system pressure is below 0.1 mTorr, press SET VAC and the number 0.00E+0 Torr will be displayed. If you want to set zero at 0.00E+0 then press the ENTER key repeatedly until the SET VAC appears on the display again. The zero point (displayed pressure reading with gauge exposed to vacuum) is now set.

If you want to set the 'zero' pressure reading to a number higher than 0.00E+0, then press the UP or DOWN keys at each of the high-lighted numeral locations until the desired number is reached; then press the ENTER key repeatedly until the SET VAC appears on the display again. The new 'zero point' is now set. Due to the nature of circuit operation and transducer electrical control that cover a wide range of measurement by a convection gauge, it is advised that one first check and adjust, if necessary, the 'span' and 'zero' to ensure that all measurements made between these two, adjusted settings are as accurate as possible.

#### - SET ATM

Setting the Span Point for CG1 (atmosphere adjustment):

1. To set the atmospheric pressure reading (also known as the "span" adjustment), flow nitrogen gas or air into your closed vacuum chamber to allow the pressure to rise to a known value above 400 Torr. Alternatively, if your local uncorrected barometric pressure (air) is known, simply vent your vacuum system chamber to expose the gauge to the local atmospheric pressure.
2. When desired system pressure is stable, press the ENTER key to access the "SET ATM" screen. Adjust the pressure on the screen to the known value using the UP or DOWN keys. Continue pressing the ENTER key until the SET ATM appears on the display again. The new atmosphere point is now set. For example, if your known local uncorrected barometric pressure is 760 Torr, enter 760 in the SET ATM screen. The CG1 pressure measurement screen will then display 760 Torr while CG1 is at atmosphere.

#### - ANALOG TYPE

This sets the analog output proportional to pressure measured from convection vacuum gauge CG1. Select analog output type as *LOG-LINEAR* or *NON-LINEAR* (S-Curve) for CG1:

*LOG-LINEAR* selection will provide a Log-Linear analog output: 1-8 Vdc, 1 V/decade

*NON-LINEAR* selection will provide a Non-Linear analog output: 0.375 to 5.659 Vdc

#### 5.8.4.2 SETUP CG2

Pressing the ENTER key will display the following three settings for CG2:

- SET VAC – Adjustment is the same as SETUP CG1 above, except using CG2.
- SET ATM – Adjustment is the same as SETUP CG1 above, except using CG2.
- ANALOG TYPE – Adjustment is the same as SETUP CG1 above, except using CG2.

**Note** - See **NOTICE** above, at [Section 5.8.4.1](#), when operating in units of mbar or Pa. You must first set the atmosphere adjustment when using either mbar or pascal engineering units of pressure.

### 5.8.5 SETUP COMMS

- **BAUD RATE** [Factory default = 19200, 8, N, 1]

This sets the baud rate for the RS485 communications. The baud rate can be set to other values manually using the front panel soft-keys.

- **ADDR** [Factory default = 1]

This is the lower nibble of the one byte RS485 device address. Assuming the address offset (ADDR OFFSET) is equal to 0, setting the ADDR to a 5 will make the address be 0x05 in hexadecimal. A 15 in decimal will set the ADDR to 0x0F in hexadecimal.

- **ADDR OFFSET** [Factory default = 0]

This is the upper nibble of the one byte RS485 address. Assuming the address (ADDR) is 0, setting the address offset (ADDR OFFSET) to a 5 will make the address be 0x50 hexadecimal. Setting the offset to 16 will make the address be 0x10 hexadecimal (see following table).

-----BINARY ADDRESS-----			
ADDRESS DECIMAL	-----ONE BYTE----- (BINARY)		ADDRESS HEXADECIMAL
	ADDR OFFSET ┌Upper nibble┐	ADDR ┌Lower nibble┐	
1	0 0 0 0	0 0 0 1	01
5	0 0 0 0	0 1 0 1	05
15	0 0 0 0	1 1 1 1	0F
16	0 0 0 1	0 0 0 0	10

- **FORMAT** [Factory default = BINARY]

This program menu function allows a choice of RS485 serial communication protocol. The BINARY setting is a binary protocol with CRC8 error checking capability used in the original IGM402 design. The ASCII setting is for use with the InstruTech ASCII protocol format used in other product designs like the IGM401 Hornet and the CVM201 Super Bee. We recommend using the **ASCII protocol** whenever possible. The BINARY protocol is uncommon, difficult to use and not compatible with readily available PLCs.

### 5.8.6 SERVICE MENU

- **INFO**

This screen provides the installed firmware part number and version. For example, when this menu choice is selected, a number such as '1769-103' may be displayed. The firmware part number is '1769' and the version is '103'.

- **OP TIME**

This screen provides information on how long the unit has been powered on regardless of filament operation.



## 5.9 Activating the IG sensor

Before you turn on the IG filament and activate the sensor, make sure you understand all instructions and information provided in this user manual. You can activate the sensor by one of the following methods:

- 1) Front Panel (manually using front panel soft-keys (see IG CNTL and FRONT PANEL in [section 5.8.2](#))
- 2) Digital Input (see IG CNTL in [section 5.8.2](#))
- 3) RS485 commands (see IG CNTL in [section 5.8.2](#))
- 4) CG1 CONT IG - using convection gauge 1 (CG1) to control IG (see IG CNTL in [section 5.8.2](#))

**Note** - It may take up to 8 seconds for the IGM402 transducer filament to turn on after it has received a turn on command via the front panel select key, Digital Inputs, or RS485 command control modes. The ion gauge measurement screen may display “UNIT STATUS OFF” during the time that the IGM402 is starting the emission and stabilizing the measurements.

## 6 Analog output

The IGM402 provides a total of three analog outputs. One analog output represents measurements from the ion gauge and the other two analog outputs represent measurements from convection gauges CG1 and CG2. The following is a list of analog output scaling choices available from the IGM402:

A) Ion gauge analog output scaling:

*IG ONLY* - Log-linear 0 to 9 Vdc, 1 V/decade, or

A1) Ion gauge plus convection gauge output scaling when used for wide range measurements:

*IG+CG1* - Log-linear 0.5 to 7 Vdc, 0.5 V/decade, and

B) Convection gauge analog output scaling:

*CG1 and CG2* - Log-linear 1 to 8 Vdc, 1 V/decade, or

*CG1 and CG2* - Non-linear 0.375 to 5.659 Vdc

The Analog Output voltage type described below represent the pressure displayed for **nitrogen / air only**. Refer to [section 7](#) if you are using a gas other than nitrogen/air.

### 6.1 Ion gauge analog output - IG ONLY

*ANALOG MODE* in *SETUP IG* menu is set to *IG ONLY*. LOG-LINEAR 0-9 Vdc, 1 V/decade (N<sub>2</sub>/ air only)

A) The log-linear output signal and pressure are related by the following formulas when units of measurement is in **Torr** and **mbar**:

$$P = 10^{(\text{volts} - 10)} \quad V = \log_{10}(P) + 10$$

Where P is the pressure in Torr or mbar, and V is the output signal in Volts.

B) The log-linear output signal and pressure are related by the following formulas when units of measurement is in **pascals**:

$$P = 10^{(\text{volts} - 8)} \quad V = \log_{10}(P) + 8$$

Where P is the pressure in pascals, and V is the output signal in Volts.

**Notes - The output voltage will switch to above +10 Vdc under the following conditions:**

- 1) The filament is turned off or any IG fault condition.
- 2) The pressure exceeds  $1.00 \times 10^{-3}$  Torr at 4 mA emission current.
- 3) The pressure exceeds  $5.0 \times 10^{-2}$  Torr at 0.1 mA (100  $\mu$ A) emission current.

**Log-Linear Analog Output (N<sub>2</sub>/air only)**

Pressure (Torr)	Voltage
1.0E-10	0.0
1.0E-09	1.0
1.0E-08	2.0
1.0E-07	3.0
1.0E-06	4.0
1.0E-05	5.0
1.0E-04	6.0
1.0E-03	7.0
1.0E-02	8.0
5.0E-02	8.698
See Notes	$\geq 10$

The following chart shows the graphical results of table and formulas above for measurements in Torr. Pressure is plotted on the X-axis with a log scale; the output signal is plotted on the Y-axis on a linear scale.

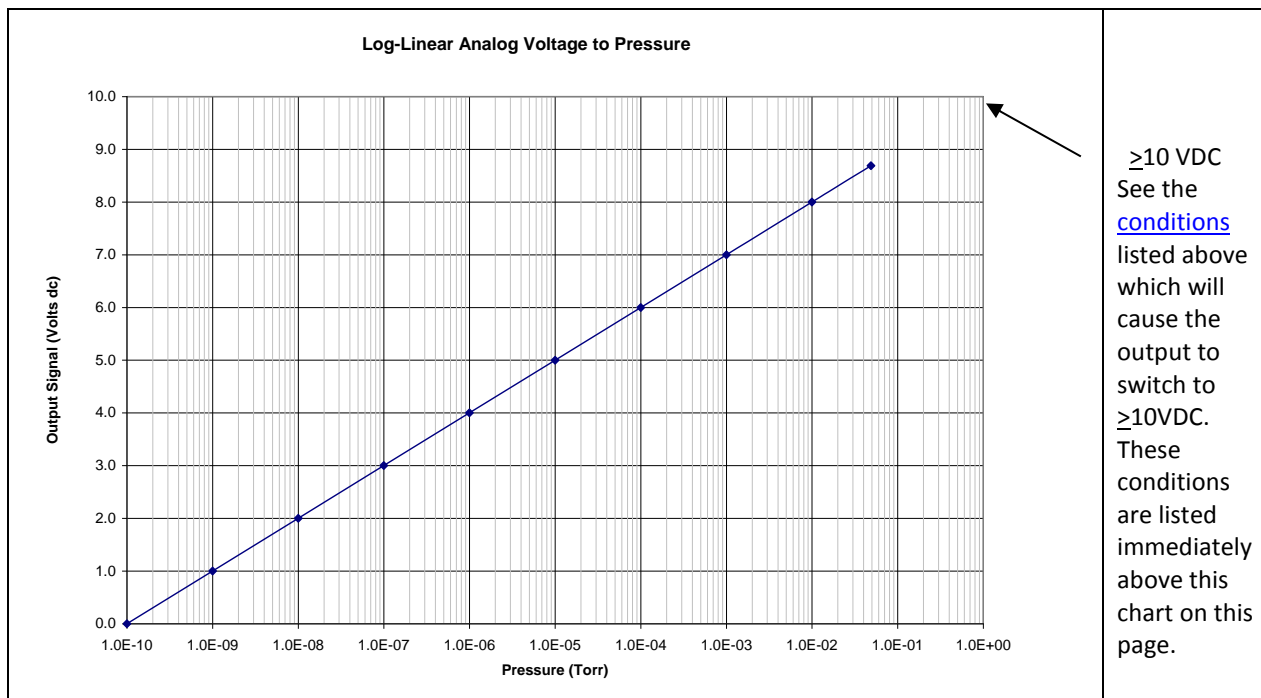

### 6.2 Ion gauge plus convection gauge analog output - IG + CG1

ANALOG MODE in SETUP IG menu is set to IG + CG1. LOG-LINEAR 0.5 to 7 Vdc, 0.5 V/decade (N<sub>2</sub>/air only)

When IG + CG1 is selected, this setting combines the measurements from IG and CG1 to provide wide range vacuum measurement. The analog output in this case is proportional to pressure from 1 x 10<sup>-9</sup> to 1,000 Torr as described below.

A) The log-linear output signal and pressure are related by the following formulas when units of measurement is in **Torr** and **mbar**:

$$P = 10^{(\text{volts} - 5.5)/(0.5)} \quad V = ((0.5 \times \log_{10}(P)) + 5.5)$$

Where P is the pressure in Torr or mbar, and V is the output signal in volts.

B) The log-linear output signal and pressure are related by the following formulas when units of measurement is in **pascals**:

$$P = 10^{(\text{volts} - 4.5)/(0.5)} \quad V = ((0.5 \times \log_{10}(P)) + 4.5)$$

**Notes - The output voltage will switch to above +10 Vdc under the following conditions:**

- 1) The filament is turned off, any IG fault condition and the CG1 is damaged or disconnected.
- 2) The pressure exceeds 1.00 x 10<sup>-3</sup> Torr at 4 mA emission current or 5.0 x 10<sup>-2</sup> Torr at 100 μA emission current and CG1 is damaged or disconnected.
- 3) Any IG or CG faults condition while operating in the IG or CG range respectively.

**Log-Linear Analog Output (N<sub>2</sub>/air only)**

Pressure (Torr)	Voltage
1.0E-10	0.5
1.0E-09	1.0
1.0E-08	1.5
1.0E-07	2.0
1.0E-06	2.5
1.0E-05	3.0
1.0E-04	3.5
1.0E-03	4.0
1.0E-02	4.5
1.0E-01	5.0
1.0E+00	5.5
1.0E+01	6.0
1.0E+02	6.5
1.0E+03	7.0
See Notes	≥10

The following chart shows the graphical results of table and formulas above for pressure measurements in Torr. Pressure is plotted on the X-axis with a log scale; the output signal is plotted on the Y-axis on a linear scale.

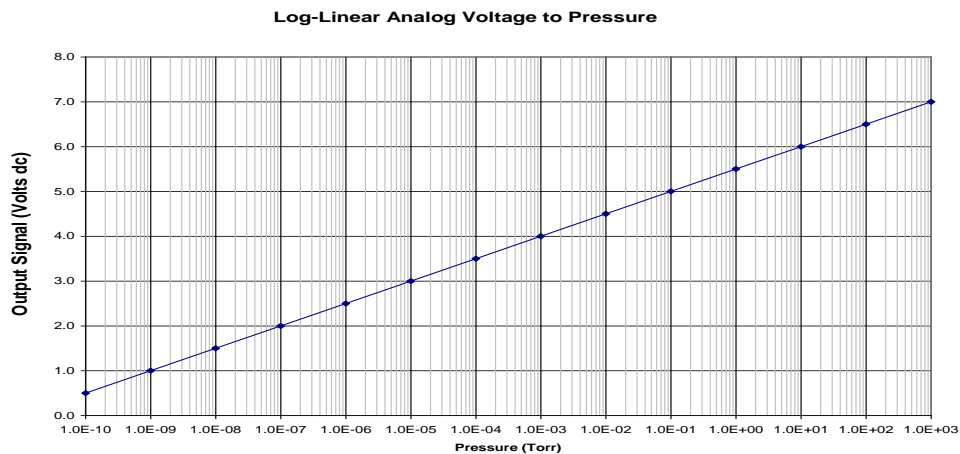

### 6.3 Convection gauge analog output - LOG-LINEAR

ANALOG TYPE in *SETUP CG1* or *SETUP CG2* sub menu of *SETUP CGS* menu is set to *LOG-LINEAR*.

1 to 8 Vdc, 1 V/decade (N<sub>2</sub>/air only)

This setting provides a log-linear analog output for convection gauges 1 and 2. The analog output is proportional to pressure measurements from either of the convection gauges 1 or 2 as described below:

A) The log-linear output signal and pressure are related by the following formulas when units of measurement is in **Torr** and **mbar**:

$$P = 10^{(\text{volts} - 5)} \quad V = \log_{10}(P) + 5$$

Where P is the pressure in Torr or mbar, and V is the output signal in volts.

B) The log-linear output signal and pressure are related by the following formulas when units of measurement is in **pascals**:

$$P = 10^{(\text{volts} - 3)} \quad V = \log_{10}(P) + 3$$

Where P is the pressure in pascals, and V is the output signal in volts.

The following chart shows the graphical results of table and formulas above for pressure measurements in Torr. Pressure is plotted on the X-axis with a log scale; the output signal is plotted on the Y-axis on a linear scale.

**Log-Linear Analog Output (N<sub>2</sub>/air only)**

Pressure (Torr)	Voltage
1.0E-04	1.000
2.0E-04	1.301
5.0E-04	1.699
1.0E-03	2.000
2.0E-03	2.301
5.0E-03	2.699
1.0E-02	3.000
2.0E-02	3.301
5.0E-02	3.699
1.0E-01	4.000
2.0E-01	4.301
5.0E-01	4.699
1.0E+00	5.000
2.0E+00	5.301
5.0E+00	5.699
1.0E+01	6.000
2.0E+01	6.301
5.0E+01	6.699
1.0E+02	7.000
2.0E+02	7.301
3.0E+02	7.477
4.0E+02	7.602
5.0E+02	7.699
6.0E+02	7.778
7.0E+02	7.845
7.6E+02	7.881
8.0E+02	7.903
9.0E+02	7.954
1.0E+03	8.000

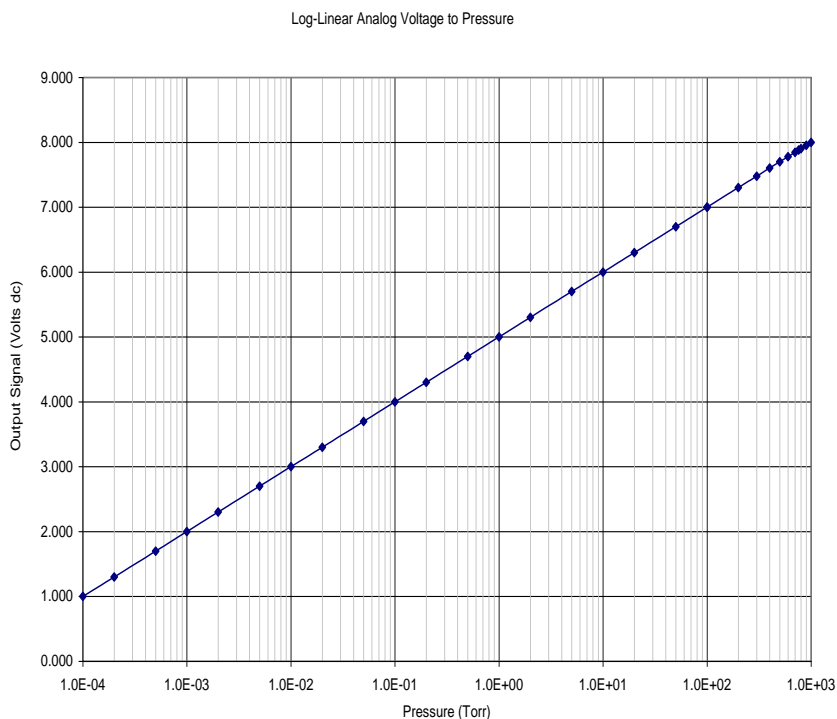

**6.4 Convection gauge analog output - NON-LINEAR**

ANALOG TYPE in *SETUP CG1* or *SETUP CG2* sub menu of *SETUP CGS* menu is set to *NON-LINEAR*.

You may calculate the N<sub>2</sub>/air pressure represented by the **0.375 to 5.659 V** non-linear analog output voltage for CG1 and CG2 Convection gauge “S-curve” using a multi-segment, n<sup>th</sup> order polynomial function calculation. The coefficients for the n<sup>th</sup> order polynomial equation defined for various pressure measurement ranges are given in the following table:

For Non-Linear Analog Output voltage range of **0.375 to 2.842 volts**, use this table.

Coefficients for $y(x) = a + bx + cx^2 + dx^3 + ex^4 + fx^5$	
a	-0.02585
b	0.03767
c	0.04563
d	0.1151
e	-0.04158
f	0.008738

For Non-Linear Analog Output voltage range of **2.842 to 4.945 volts**, use this table.

Coefficients for $y(x) = \frac{a+cx+ex^2}{1+bx+dx^2+fx^3}$	
a	0.1031
b	-0.3986
c	-0.02322
d	0.07438
e	0.07229
f	-0.006866

For Non-Linear Analog Output voltage range of **4.94 to 5.659 volts**, use this table.

Coefficients for $y(x) = \frac{a+cx}{1+bx+dx^2}$	
a	100.624
b	-0.37679
c	-20.5623
d	0.0348656

Where  $y(x)$  = pressure in Torr,  $x$  = measured analog output in volts

Example: Measured analog output voltage is 0.3840 V.

From first table shown above use equation:

$$y(x) = a + bx + cx^2 + dx^3 + ex^4 + fx^5$$

X = 0.3840 volts

A = -0.02585, b=0.03767, c=0.04563, d=0.1151, e=-0.04158, f=0.008738

$y(x)$  = Pressure = 1.0E-03 Torr

The equations listed above are used to calculate the non-linear voltage outputs for N<sub>2</sub>/air shown in the table below.

The non-linear S-curve is convenient if you are replacing a Granville-Phillips® Convector® which has that output, and you do not want to change anything in the control system. For new systems, however, the formulas needed to interpret the non-linear signal are complex and difficult to use. The log-linear signal is generally easier to interface with today's data acquisition and control systems.

*Non-Linear Output*

Granville-Phillips® first Convector® gauge controllers produced a non-linear output signal of 0.375 to 5.659 Vdc for 0 to 1000 Torr of N<sub>2</sub>, roughly in the shape of an "S" curve, as shown at right. GP adopted the same output curve for most of their Mini-Convector® modules and controllers with non-linear output. (though in recent years, some GP controllers produced a different S-curve)

The non-linear output from InstruTech convection gauges, modules, and controllers duplicates exactly the original S-curve of 0.375 to 5.659 Vdc for 0 to 1000 Torr.

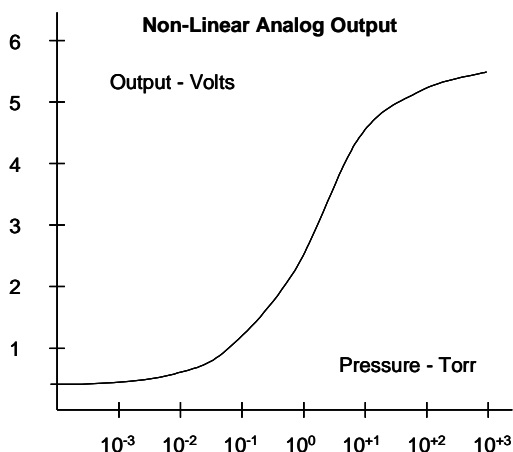

**Non-Linear Analog Output  
(N<sub>2</sub> /air only)**

Pressure (Torr)	Voltage
0.0000	0.3751
1.0E-04	0.3759
2.0E-04	0.3768
5.0E-04	0.3795
1.0E-03	0.3840
2.0E-03	0.3927
5.0E-03	0.4174
1.0E-02	0.4555
2.0E-02	0.5226
5.0E-02	0.6819
1.0E-01	0.8780
2.0E-01	1.1552
5.0E-01	1.6833
1.0E+00	2.2168
2.0E+00	2.8418
5.0E+00	3.6753
1.0E+01	4.2056
2.0E+01	4.5766
5.0E+01	4.8464
1.0E+02	4.9449
2.0E+02	5.0190
3.0E+02	5.1111
4.0E+02	5.2236
5.0E+02	5.3294
6.0E+02	5.4194
7.0E+02	5.4949
7.6E+02	5.5340
8.0E+02	5.5581
9.0E+02	5.6141
1.0E+03	5.6593

## 7 Using the gauge with different gases

The IGM402 pressure display assumes that the pressure measurement device is reading nitrogen pressure. For both convection and ionization type vacuum gauges, corrections must be applied to both the display and analog outputs.

**NOTICE**

The following tables and text contain important information regarding the use of ionization and convection gauges when measuring total pressure of gas and gas mixtures other than Nitrogen / Air. For both types of gauge transducers, corrections must be applied to both the displayed pressure and the analog output to determine the true measured pressure. This is particularly critical when using convection gauges to measure density of gases other than N<sub>2</sub>/Air.

 **CAUTION!** Risk of over pressurizing a gas containment vessel and attached apparatus exists when using pressure measurement devices that are calibrated for a specific gas type. Use a pressure relief device to safely limit the internal pressure of a containment vessel to less than the maximum allowable working pressure rating for the vacuum/pressure system and all devices attached to the system.

### 7.1 *Effects of different gas types on ionization gauge display*

Ion gauge pressure readings are calibrated for nitrogen. If you use a different species of gas or mixture of gases, you will be required to either make manual corrections to the pressure readout or compensate the reading. The Sensitivity adjustment function of the IGM402 you are using to measure the pressure of gas other than nitrogen/air may be set to compensate the reading. Compensating the pressure reading using the Sensitivity adjustment method may not be possible for certain gases if the sensitivity correction factor results in a calculated sensitivity outside the adjustment range possible.

### 7.1.1 Ion gauge display correction factors for selected gases

If you intend to use gases other than N<sub>2</sub> / Air, you must manually apply a gas sensitivity correction factor to the IG displayed pressure measurement. The following table provides correction factors for some typical gas species. To correct the display measurement, divide the displayed measured pressure by the correction factor for the gas type being measured by your ionization gauge device:

Gas	Sensitivity Correction Factor	Gas	Sensitivity Correction Factor
He	0.18	H <sub>2</sub> O	1.12
Ne	0.30	NO	1.16
D <sub>2</sub>	0.35	Ar	1.29
H <sub>2</sub>	0.46	CO <sub>2</sub>	1.42
N <sub>2</sub>	1.00	Kr	1.94
Air	1.00	SF <sub>6</sub>	2.50
O <sub>2</sub>	1.01	Xe	2.87
CO	1.05	Hg	3.64

#### Ion Gauge Gas Sensitivity Correction Factors for selected gases

For example, if the gas in use is argon (Ar) and the ion gauge display indicates a measured pressure of 1.00E-6 Torr, from the table above for Ion Gauge Gas Sensitivity Correction Factors, the correction factor for argon is 1.29. Divide the displayed pressure, 1.00E-6 Torr, by the correction factor, 1.29, to obtain the true pressure of argon gas in your vacuum chamber:  $P(\text{argon}) = \frac{1.0 \times 10^{-6}}{1.29} = 7.75 \times 10^{-7}$  Torr true pressure of **argon** gas

If you adjust the Sensitivity factor for your ion gauge to compensate the readout of pressure for a gas type other than nitrogen, the displayed pressure readout for that device must be annotated to indicate that the displayed pressure is for the gas type the readout is compensated for. In the above example, if the N<sub>2</sub> Sensitivity of the ion gauge being used is 10 torr<sup>-1</sup> (“10 per torr”), the Sensitivity factor programmed during setup of the IGM402 for could be set for 12.9 (~13) so that the pressure readout would indicate the true pressure of argon. Again, the display line for that particular device pressure readout would require annotation so as to not conflict with the notation “N<sub>2</sub>” following the “Unit” notation in the Pressure Measurement Screen.

### 7.2 Effects of different gases on convection gauge display

A thermal conductivity gauge senses heat loss, which depends on the thermal conductivity of the gas surrounding the sensor. Since different gases, and mixtures, have different thermal conductivities, the indicated pressure readings and outputs will also be different. InstruTech convection gauges (and most other thermal gauges) are normally calibrated using dry nitrogen (N<sub>2</sub>). When a gas other than nitrogen is used, correction must be made for the difference in thermal conductivity, between nitrogen (N<sub>2</sub>) and the gas in use. The charts and tables on the following pages indicate how different gases affect the display and output from an InstruTech convection gauge.



**WARNING!** Using a thermal conductivity gauge with gases other than that for which it is calibrated could result in death or serious injury. Be sure to use gas correction data in this manual when measuring pressures of gases other than N<sub>2</sub>/ air.

For N<sub>2</sub> the calibration shows excellent agreement between indicated and true pressure throughout the range from 10<sup>-4</sup> to 1000 Torr. At pressures below 1 Torr, the calibration curves for the different gases are similar. The difference in readings at these low pressures is a constant, a function of the difference between thermal conductivities of the gases.

At pressures above 1 Torr, indicated pressure readings may diverge significantly. At these higher pressures, convection currents in the gauge become the predominant cause of heat loss from the sensor, and calibration depends on gauge tube geometry and mounting position, as well as gas properties.

Generally, air and N<sub>2</sub> are considered the same with respect to thermal conductivity, but even N<sub>2</sub> and air will exhibit slight differences in readings at higher pressures. For example, when venting a system to atmosphere using N<sub>2</sub>, you may see readings change by 30 to 40 Torr after the chamber is opened and air gradually displaces the N<sub>2</sub> in the gauge. For most other gases, the effect is much more significant, and may result in a hazardous condition if the appropriate gas conversion data is not applied.

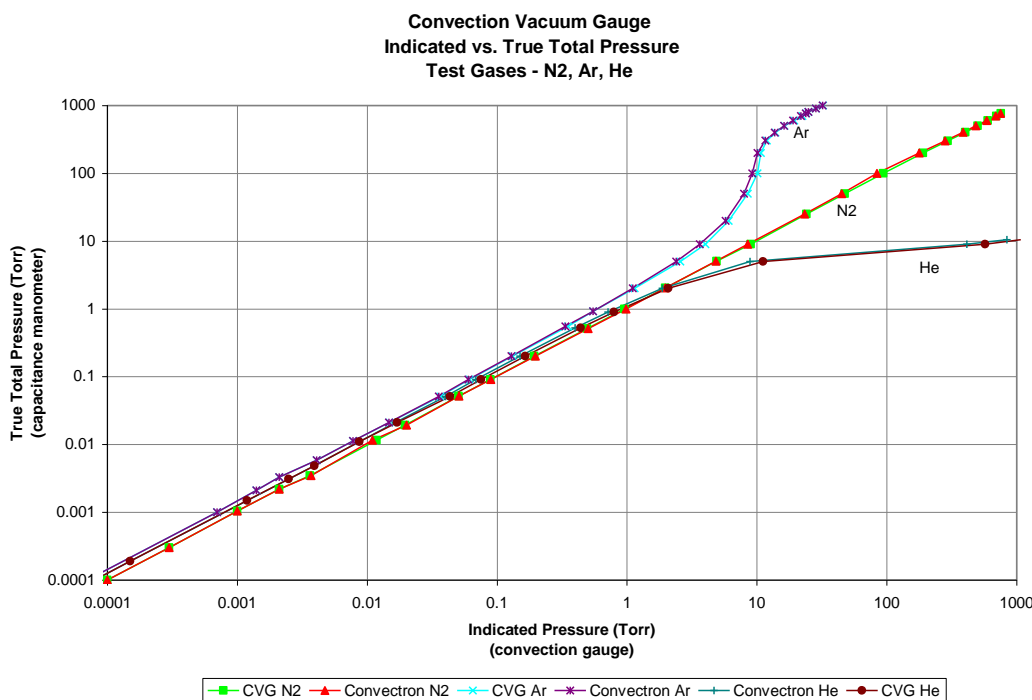

The Y- Axis is actual pressure, measured by a capacitance manometer, a diaphragm gauge that measures true total pressure, independent of gas composition. The X-Axis is the pressure reading indicated by the convection gauge under test. The chart above shows readings for an InstruTech’s CVG101 convection gauges as well as for a Granville-Phillips® Convector® gauge, to illustrate that the response of both these type of gauges is virtually the same.

### 7.2.1 Convection gauge display conversion for selected gases

When using gas species or mixtures of gas other than nitrogen or air, you must use a look-up table to determine the true pressure of the selected gas as measured by the convection gauge. This holds true for any manufacturer's convection enhanced pirani type transducer where the principle of measurement is based on heat-loss from a heated wire contained in the vacuum gauge transducer volume exposed to the inlet gas or gas mixture.

Refer to the look-up table on the next page and note the following examples:

Example A: If the gas is nitrogen ( $N_2$ ), when the true total pressure is 500 Torr, the gauge will read 500 Torr.

Example B: If the gas is argon (Ar), when the true pressure is 100 Torr, the gauge will read about 9 Torr.

If you are backfilling your vacuum system with Ar, when your system reaches a true pressure of 760 Torr, your gauge will be reading about 23.7 Torr. Continuing to backfill your chamber in an attempt to increase the displayed pressure reading to 760 Torr will over pressurize your chamber which may present a hazard.

Example C: If the gas is helium (He), the gauge will read OP (Overpressure) when pressure reaches about 10 Torr true pressure and opening the chamber to atmosphere prematurely may present other hazards for both people and product.

**CAUTION!** What these examples illustrate is that when using gases other than nitrogen ( $N_2$ ) / air, without using accurate gas conversion data and other proper precautions, could result in injury to personnel and/or damage to equipment.

#### ***Suggested precautions when using gases other than $N_2$ / air:***

Exercise caution when admitting positive pressures (above local ambient, atmospheric pressure) of gas into any enclosed volume. Install pressure relief devices on your vacuum / pressure vessel or chamber to limit the maximum allowable working pressure inside the devices and vessel internal volume to less than the lowest rated device - in some cases, the maximum allowable working pressure may be dictated by the type of connections or fittings used to attach devices to your chamber. An O-ring compression fitting type device may be forcibly released (ejected) from the fitting if internal pressure exceeds the local barometric, ambient pressure.

Post a warning label on your gauge readout "Do Not Exceed \_\_\_\_ Torr Indicated Pressure" (fill in the blank for maximum indicated pressure for the gas you use) so that an operator using the gauge will not exceed a safe pressure.

**CAUTION!** Do not assume this data applies to other convection gauges, which may or may not be the same.

The table below shows the convection gauge displayed readings at various pressures for several commonly used gas types:

**Displayed pressure readings for convection gauge type devices versus true pressure for selected gases**

True Pressure (Torr)	N <sub>2</sub>	Ar	He	O <sub>2</sub>	CO <sub>2</sub>	Kr	Freon12	Freon22	D <sub>2</sub>	Ne	CH <sub>4</sub>
1.00E-4	1.00E-4	1.00E-4	1.00E-4	1.00E-4	1.00E-4	1.00E-4	1.00E-4	1.00E-4	1.00E-4	1.00E-4	1.00E-4
2.00E-4	2.00E-4	2.00E-4	2.00E-4	2.00E-4	2.00E-4	2.00E-4	2.00E-4	2.00E-4	2.00E-4	2.00E-4	2.00E-4
5.00E-4	5.00E-4	5.00E-4	5.00E-4	5.00E-4	5.00E-4	3.00E-4	5.00E-4	5.00E-4	5.00E-4	5.00E-4	5.00E-4
1.00E-3	1.00E-3	7.00E-4	8.00E-4	1.00E-3	1.10E-3	4.00E-4	1.50E-3	1.50E-3	1.30E-3	7.00E-4	1.70E-3
2.00E-3	2.00E-3	1.40E-3	1.60E-3	2.00E-3	2.30E-3	1.00E-3	3.10E-3	3.10E-3	2.40E-3	1.50E-3	3.30E-3
5.00E-3	5.00E-3	3.30E-3	4.00E-3	5.00E-3	4.40E-3	2.30E-3	7.60E-3	7.00E-3	6.00E-3	3.50E-3	7.70E-3
1.00E-2	1.00E-2	6.60E-3	8.10E-3	9.70E-3	1.10E-2	4.80E-3	1.47E-2	1.35E-2	1.21E-2	7.10E-3	1.53E-2
2.00E-2	2.00E-2	1.31E-2	1.61E-2	1.98E-2	2.22E-2	9.50E-3	2.99E-2	2.72E-2	2.43E-2	1.41E-2	3.04E-2
5.00E-2	5.00E-2	3.24E-2	4.05E-2	4.92E-2	5.49E-2	2.35E-2	7.25E-2	6.90E-2	6.00E-2	3.48E-2	7.72E-2
1.00E-1	1.00E-1	6.43E-2	8.20E-2	9.72E-2	1.07E-1	4.68E-2	1.43E-1	1.36E-1	1.21E-1	7.00E-2	1.59E-1
2.00E-1	2.00E-1	1.26E-1	1.65E-1	1.94E-1	2.10E-1	9.11E-2	2.75E-1	2.62E-1	2.50E-1	1.41E-1	3.15E-1
5.00E-1	5.00E-1	3.12E-1	4.35E-1	4.86E-1	4.89E-1	2.17E-1	6.11E-1	5.94E-1	6.87E-1	3.59E-1	7.81E-1
1.00E+0	1.00E+0	6.00E-1	9.40E-1	9.70E-1	9.50E-1	4.00E-1	1.05E+0	1.04E+0	1.55E+0	7.45E-1	1.60E+0
2.00E+0	2.00E+0	1.14E+0	2.22E+0	1.94E+0	1.71E+0	7.00E-1	1.62E+0	1.66E+0	4.13E+0	1.59E+0	3.33E+0
5.00E+0	5.00E+0	2.45E+0	1.35E+1	4.98E+0	3.34E+0	1.28E+0	2.45E+0	2.62E+0	2.46E+2	5.24E+0	7.53E+0
1.00E+1	1.00E+1	4.00E+0	OP	1.03E+1	4.97E+0	1.78E+0	2.96E+0	3.39E+0	OP	2.15E+1	2.79E+1
2.00E+1	2.00E+1	5.80E+0	OP	2.23E+1	6.59E+0	2.29E+0	3.32E+0	3.72E+0	OP	5.84E+2	3.55E+2
5.00E+1	5.00E+1	7.85E+0	OP	7.76E+1	8.22E+0	2.57E+0	3.79E+0	4.14E+0	OP	OP	8.42E+2
1.00E+2	1.00E+2	8.83E+0	OP	2.09E+2	9.25E+0	2.74E+0	4.68E+0	4.91E+0	OP	OP	OP
2.00E+2	2.00E+2	9.79E+0	OP	2.95E+2	1.23E+1	3.32E+0	5.99E+0	6.42E+0	OP	OP	OP
3.00E+2	3.00E+2	1.13E+1	OP	3.80E+2	1.69E+1	3.59E+0	6.89E+0	7.52E+0	OP	OP	OP
4.00E+2	4.00E+2	1.35E+1	OP	4.85E+2	2.24E+1	3.94E+0	7.63E+0	8.42E+0	OP	OP	OP
5.00E+2	5.00E+2	1.61E+1	OP	6.04E+2	2.87E+1	4.21E+0	8.28E+0	9.21E+0	OP	OP	OP
6.00E+2	6.00E+2	1.88E+1	OP	7.30E+2	3.64E+1	4.44E+0	8.86E+0	9.95E+0	OP	OP	OP
7.00E+2	7.00E+2	2.18E+1	OP	8.59E+2	4.61E+1	4.65E+0	9.42E+0	1.07E+1	OP	OP	OP
7.60E+2	7.60E+2	2.37E+1	OP	9.41E+2	5.39E+1	4.75E+0	9.76E+0	1.11E+1	OP	OP	OP
8.00E+2	8.00E+2	2.51E+1	OP	9.97E+2	5.94E+1	4.84E+0	9.95E+0	1.14E+1	OP	OP	OP
9.00E+2	9.00E+2	2.85E+1	OP	OP	7.95E+1	4.99E+0	1.05E+1	1.20E+1	OP	OP	OP
1.00E+3	1.00E+3	3.25E+1	OP	OP	1.11E+2	5.08E+0	1.11E+1	1.27E+1	OP	OP	OP

Values listed under each gas type are in Torr units.

OP = Overpressure

Example: If the gas is argon (Ar), when the true pressure is 100 Torr, the gauge will read about 9 torr.

### 7.3 Effect of different gases on analog output

The following tables and explanation contains important information regarding the use of ionization and convection gauges on gases other than N<sub>2</sub> / Air. For both types of gauges, corrections must be applied to the analog outputs.

#### 7.3.1 Ion gauge analog output correction factors for selected gases

When using the 0-9 V Log-Linear analog output for the ion gauge, use the following steps to convert the analog output to pressure:

- Refer to [section 6.1](#) and use the related equation to convert the voltage in your receiving instrument to pressure. This pressure value is based on nitrogen gas.
- Apply the Sensitivity Correction Factor for the particular gas you are using to the pressure value obtained in step A. Use correction factors and example listed below:

#### Ion Gauge Gas Sensitivity Correction Factors for selected gases

Gas	Sensitivity Correction Factor
He	0.18
Ne	0.30
D <sub>2</sub>	0.35
H <sub>2</sub>	0.46
N <sub>2</sub>	1.00
Air	1.00
O <sub>2</sub>	1.01
CO	1.05

Gas	Sensitivity Correction Factor
H <sub>2</sub> O	1.12
NO	1.16
Ar	1.29
CO <sub>2</sub>	1.42
Kr	1.94
SF <sub>6</sub>	2.50
Xe	2.87
Hg	3.64

#### Example:

The gas in use is argon. Voltage output is 4 volts. Pressure unit is torr.

$$P(\text{nitrogen}) = 10^{(\text{volts} - 10)}$$

$$P = 10^{(4 - 10)}$$

$$P = 1.0 \times 10^{-6} \text{ Torr (based on nitrogen)}$$

Applying the Sensitivity Correction Factor of 1.29 for argon listed in the table above,

$$P(\text{argon}) = \frac{1.0 \times 10^{-6}}{1.29} = 7.75 \times 10^{-7} \text{ Torr true pressure of argon gas}$$

The correction factor must be applied to the analog output over the entire pressure range measured by the ion gauge.

**7.3.2 IG + CG1 analog output correction factors for selected gases**

When using the IG + CG1 analog output mode (Log-Linear 0.5 - 7 V, 0.5 V/decade) for gases other than N<sub>2</sub> / Air, the analog output is interpreted differently over two different pressure ranges as discussed below:

- A) **Pressure range from the 1.0 x 10<sup>-9</sup> Torr to 1.0E-03 Torr:**  
Use the information and equation described in [section 6.2](#) and the correction factors listed in [section 7.3.2.1](#) below to determine pressure from the voltage for selected gases (ion gauge range).
- B) **Pressure range from 1.0E-03 to 1,000 Torr:**  
Use the correction factors listed in [section 7.3.2.2](#) below to determine pressure from the voltage for selected gases (convection gauge range).

**7.3.2.1 IG + CG1 analog output correction factors - Ion gauge range**

- A) When using the IG + CG1 analog output mode (Log-Linear 0.5 - 7 V, 0.5 V/decade) for gases other than N<sub>2</sub> / Air, use the following steps to convert the analog output to pressure when operating in the pressure range of 1.0 x 10<sup>-9</sup> Torr to 1.0E-03 Torr.
- B) Refer to [section 6.2](#) and related equation to convert the voltage in your receiving instrument to pressure. This pressure value is based on nitrogen.
- C) Apply the sensitivity correction factor for the particular gas you are using to the pressure value obtained in step A (Use correction factors and example listed below).

**Ion Gauge Gas Sensitivity Correction Factors for selected gases**

Gas	Sensitivity Correction Factor	Gas	Sensitivity Correction Factor
He	0.18	H <sub>2</sub> O	1.12
Ne	0.30	NO	1.16
D <sub>2</sub>	0.35	Ar	1.29
H <sub>2</sub>	0.46	CO <sub>2</sub>	1.42
N <sub>2</sub>	1.00	Kr	1.94
Air	1.00	SF <sub>6</sub>	2.50
O <sub>2</sub>	1.01	Xe	2.87
CO	1.05	Hg	3.64

*Example:*

The gas in use is argon. Output voltage is 3 volts. Pressure unit is torr.

$$P(\text{nitrogen}) = 10^{\frac{\text{volts}-5.5}{0.5}} = 10^{(3.0-5.5)/(0.5)}, P = 1 \times 10^{-5} \text{ Torr (based on nitrogen)}$$

$$P(\text{argon}) = \frac{1 \times 10^{-5}}{1.29} = 7.75 \times 10^{-6} \text{ Torr true pressure of argon gas}$$

The same correction factor must be applied over the entire pressure range as measured by the ion gauge.

**7.3.2.2 IG + CG1 analog output correction factors - Convection gauge range**

When using the IG + CG1 analog output mode (Log-Linear 0.5 - 7 V, 0.5 V/decade) for gases other than N<sub>2</sub> / Air, use the following look-up table and information to convert the analog output to pressure when operating in the convection gauge pressure measurement range. The look-up table has been derived from equation listed in [section 6.2](#).

**Analog output IG + CG1 mode when in the pressure range of overpressure shutdown value to 1,000 Torr**

True Pressure (Torr)	N <sub>2</sub>	Ar	He	O <sub>2</sub>	CO <sub>2</sub>	KR	Freon12	Freon22	D <sub>2</sub>	Ne	CH <sub>4</sub>
1.00E-3	4.000	3.923	3.952	4.000	4.021	3.801	4.088	4.088	4.057	3.923	4.115
2.00E-3	4.151	4.073	4.102	4.151	4.181	4.000	4.246	4.246	4.190	4.088	4.259
5.00E-3	4.349	4.259	4.301	4.349	4.322	4.181	4.440	4.423	4.389	4.272	4.443
1.00E-2	4.500	4.410	4.454	4.493	4.521	4.341	4.584	4.565	4.541	4.426	4.592
2.00E-2	4.651	4.559	4.603	4.648	4.673	4.489	4.738	4.717	4.693	4.575	4.741
5.00E-2	4.849	4.755	4.804	4.846	4.870	4.686	4.930	4.919	4.889	4.771	4.944
1.00E-1	5.000	4.904	4.957	4.994	5.015	4.835	5.078	5.067	5.041	4.923	5.101
2.00E-1	5.151	5.050	5.109	5.144	5.161	4.980	5.220	5.209	5.199	5.075	5.249
5.00E-1	5.349	5.247	5.319	5.343	5.345	5.168	5.393	5.387	5.418	5.278	5.446
1.00E+0	5.500	5.389	5.487	5.493	5.489	5.301	5.511	5.509	5.595	5.436	5.602
2.00E+0	5.651	5.528	5.673	5.644	5.616	5.423	5.605	5.610	5.808	5.601	5.761
5.00E+0	5.849	5.695	6.065	5.849	5.762	5.554	5.695	5.709	6.695	5.860	5.938
1.00E+1	6.000	5.801		6.006	5.848	5.625	5.736	5.765		6.166	6.223
2.00E+1	6.151	5.882		6.174	5.909	5.680	5.761	5.785		6.883	6.775
5.00E+1	6.349	5.947		6.445	5.957	5.705	5.789	5.809			6.963
1.00E+2	6.500	5.973		6.660	5.983	5.719	5.835	5.846			
2.00E+2	6.651	5.995		6.735	6.045	5.761	5.889	5.904			
3.00E+2	6.739	6.027		6.790	6.114	5.778	5.919	5.938			
4.00E+2	6.801	6.065		6.843	6.175	5.798	5.941	5.963			
5.00E+2	6.849	6.103		6.891	6.229	5.812	5.959	5.982			
6.00E+2	6.889	6.137		6.932	6.281	5.824	5.974	5.999			
7.00E+2	6.923	6.169		6.967	6.332	5.834	5.987	6.015			
7.60E+2	6.940	6.187		6.987	6.366	5.838	5.995	6.023			
8.00E+2	6.952	6.200		6.999	6.387	5.842	5.999	6.028			
9.00E+2	6.977	6.227			6.450	5.849	6.011	6.040			
1.00E+3	7.000	6.256			6.523	5.853	6.023	6.052			

Values listed under each gas type are in volts (Vdc).

*Example:*

The gas in use is O<sub>2</sub>. Voltage output is 5.144 volts.  
True pressure of O<sub>2</sub> is 2.0E-01 Torr

### 7.3.3 Convection gauge analog output for selected gases

If you intend to use one or two of the convection gauge analog outputs for gases other than N<sub>2</sub> / Air, you must also apply corrections to the analog output. Use the following tables to determine pressure from voltage for gases other than nitrogen or air.

#### 7.3.3.1 Log-Linear CG analog output correction factors

When using the Log-Linear convection gauge analog output mode (Log-Linear 1 - 8 V, 1 V/decade) for gases other than N<sub>2</sub> /, use the following look-up table and information to convert the analog output to pressure. The look-up table has been derived from the equation provided in [section 6.3](#).

**Analog Output for Log-Linear CG 1-8 V**

True Pressure (Torr)	N <sub>2</sub>	Ar	He	O <sub>2</sub>	CO <sub>2</sub>	KR	Freon12	Freon22	D <sub>2</sub>	Ne	CH <sub>4</sub>
1.00E-4	1.000	1.000	1.000	1.000	1.000	1.000	1.000	1.000	1.000	1.000	1.000
2.00E-4	1.301	1.301	1.301	1.301	1.301	1.301	1.301	1.301	1.301	1.301	1.301
5.00E-4	1.699	1.699	1.699	1.699	1.699	1.477	1.699	1.699	1.699	1.699	1.699
1.00E-3	2.000	1.845	1.903	2.000	2.041	1.602	2.176	2.176	2.114	1.845	2.230
2.00E-3	2.301	2.146	2.204	2.301	2.362	2.000	2.491	2.491	2.380	2.176	2.519
5.00E-3	2.699	2.519	2.602	2.699	2.643	2.362	2.881	2.845	2.778	2.544	2.886
1.00E-2	3.000	2.820	2.908	2.987	3.041	2.681	3.167	3.130	3.083	2.851	3.185
2.00E-2	3.301	3.117	3.207	3.297	3.346	2.978	3.476	3.435	3.386	3.149	3.483
5.00E-2	3.699	3.511	3.607	3.692	3.740	3.371	3.860	3.839	3.778	3.542	3.888
1.00E-1	4.000	3.808	3.914	3.988	4.029	3.670	4.155	4.134	4.083	3.845	4.201
2.00E-1	4.301	4.100	4.217	4.288	4.322	3.960	4.439	4.418	4.398	4.149	4.498
5.00E-1	4.699	4.494	4.638	4.687	4.689	4.336	4.786	4.774	4.837	4.555	4.893
1.00E+0	5.000	4.778	4.973	4.987	4.978	4.602	5.021	5.017	5.190	4.872	5.204
2.00E+0	5.301	5.057	5.346	5.288	5.233	4.845	5.210	5.220	5.616	5.201	5.522
5.00E+0	5.699	5.389	6.130	5.697	5.524	5.107	5.389	5.418	7.391	5.719	5.877
1.00E+1	6.000	5.602		6.013	5.696	5.250	5.471	5.530		6.332	6.446
2.00E+1	6.301	5.763		6.348	5.819	5.360	5.521	5.571		7.766	7.550
5.00E+1	6.699	5.895		6.890	5.915	5.410	5.579	5.617			7.925
1.00E+2	7.000	5.946		7.320	5.966	5.438	5.670	5.691			
2.00E+2	7.301	5.991		7.470	6.090	5.521	5.777	5.808			
3.00E+2	7.477	6.053		7.580	6.228	5.555	5.838	5.876			
4.00E+2	7.602	6.130		7.686	6.350	5.595	5.883	5.925			
5.00E+2	7.699	6.207		7.781	6.458	5.624	5.918	5.964			
6.00E+2	7.778	6.274		7.863	6.561	5.647	5.947	5.998			
7.00E+2	7.845	6.338		7.934	6.664	5.667	5.974	6.029			
7.60E+2	7.881	6.375		7.974	6.732	5.677	5.989	6.045			
8.00E+2	7.903	6.400		7.999	6.774	5.685	5.998	6.057			
9.00E+2	7.954	6.455			6.900	5.698	6.021	6.079			
1.00E+3	8.000	6.512			7.045	5.706	6.045	6.104			

Values listed under each gas type are in volts (Vdc).

**7.3.3.2 Non-Linear CG analog output correction factors**

When using the Non-Linear CG analog output, use the following look-up table and information to convert the analog output to pressure.

**Analog Output for Non-Linear CG**

True Pressure (Torr)	N <sub>2</sub>	Ar	He	O <sub>2</sub>	CO <sub>2</sub>	KR	Freon12	Freon22	D <sub>2</sub>	Ne	CH <sub>4</sub>
0	0.3751	0.375	0.375	0.375	0.375	0.375	0.375	0.375	0.375	0.375	0.375
1.00E-4	0.3759	0.3757	0.3755	0.376	0.376	0.3755	0.376	0.376	0.376	0.3757	0.3766
2.00E-4	0.3768	0.376	0.3765	0.377	0.377	0.3768	0.378	0.378	0.377	0.3763	0.378
5.00E-4	0.3795	0.378	0.379	0.38	0.381	0.3772	0.382	0.381	0.381	0.3782	0.3825
1.00E-3	0.384	0.381	0.382	0.384	0.385	0.379	0.388	0.388	0.386	0.381	0.3896
2.00E-3	0.3927	0.387	0.389	0.392	0.395	0.384	0.401	0.4	0.396	0.388	0.403
5.00E-3	0.4174	0.403	0.409	0.417	0.412	0.395	0.437	0.432	0.425	0.405	0.438
1.00E-2	0.4555	0.429	0.441	0.453	0.462	0.415	0.488	0.48	0.47	0.433	0.492
2.00E-2	0.5226	0.477	0.497	0.521	0.536	0.451	0.581	0.566	0.549	0.484	0.584
5.00E-2	0.6819	0.595	0.637	0.679	0.705	0.544	0.778	0.764	0.727	0.608	0.796
1.00E-1	0.878	0.745	0.814	0.868	0.9	0.668	1.009	0.99	0.944	0.768	1.053
2.00E-1	1.1552	0.962	1.068	1.141	1.179	0.847	1.315	1.291	1.265	1.002	1.392
5.00E-1	1.6833	1.386	1.589	1.664	1.668	1.194	1.826	1.805	1.914	1.469	2.014
1.00E+0	2.2168	1.818	2.164	2.195	2.172	1.536	2.257	2.247	2.603	1.976	2.632
2.00E+0	2.8418	2.333	2.939	2.814	2.695	1.921	2.647	2.666	3.508	2.631	3.313
5.00E+0	3.6753	3.028	4.387	3.672	3.316	2.429	3.029	3.09	5.059	3.715	
1.00E+1	4.2056	3.48	5.774	4.225	3.67	2.734	3.204	3.33	6.361	4.605	4.699
2.00E+1	4.5766	3.801	7.314	4.62	3.903	2.966	3.308	3.414		5.406	5.172
5.00E+1	4.8464	4.037		4.916	4.071	3.075	3.43	3.509		6.159	5.583
1.00E+2	4.9449	4.122		5.026	4.154	3.134	3.618	3.66		6.483	5.72
2.00E+2	5.019	4.192		5.106	4.336	3.269	3.827	3.883		6.661	5.86
3.00E+2	5.1111	4.283		5.2	4.502	3.384	3.938	4.005		6.726	
4.00E+2	5.2236	4.386		5.315	4.621	3.466	4.016	4.088		6.767	6.103
5.00E+2	5.3294	4.477		5.422	4.708	3.526	4.076	4.151		6.803	
6.00E+2	5.4194	4.55		5.515	4.775	3.573	4.124	4.203		6.843	6.342
7.00E+2	5.4949	4.611		5.592	4.83	3.613	4.166	4.247		6.89	
7.60E+2	5.534	4.643		5.633	4.86	3.632	4.19	4.271		6.92	
8.00E+2	5.5581	4.663		5.658	4.877	3.645	4.203	4.286		6.942	6.519
9.00E+2	5.6141	4.706		5.713	4.919	3.674	4.237	4.321		7	
1.00E+3	5.6593	4.745		5.762	4.955	3.69	4.27	4.354		7.056	6.642

Values listed under each gas type are in volts (Vdc).



## 8 RS485 serial communications

Two distinctly different RS485 serial communications protocols are available with the IGM402. The first, referred to as 'BINARY' protocol uses a cyclic redundancy check (CRC) of 8 bits (CRC8) which is similar to the automotive industry standard J1850 requirements. Sections [8.1](#) and [8.2](#) of this user manual apply only to the 'BINARY' protocol version.

The second is the ASCII protocol. Refer to Section [8.3](#) and [8.4](#) for the 'ASCII' protocol version also available for use when communicating with the IGM402 over the EIA485 interface.

'BINARY' protocol is the device default setting however we recommend using the **ASCII protocol** whenever possible. The BINARY protocol is uncommon, difficult to use and not compatible with readily available PLCs.

### 8.1 Device Specific Serial Communication Info - BINARY Protocol with CRC8

The standard IGM402 model provides RS485 serial communications. The following information and the RS485 command protocol summary listed in [section 8.2](#) can be used to establish serial communications with the IGM402.

1. Default settings are **19,200** baud rate, **8** data bits, **No Parity**, **1** stop bit [Factory default; 19,200, 8, N, 1].
2. The baud rate can be set to various values using the front panel selection keys. See SET COMMS BAUD RATE in section [8.2](#) table for baud rates available. Baud rate used by device (slave) must be the same as used by the host (master).
3. Minimum interval between commands sent out over the RS485 bus is 50 msec.
4. 'xx' is the address of the device (00 thru FF).
5. <CR> represents a carriage return, a non-printable character. Do not enter <CR> from your keyboard. A carriage return, non-printable character may be entered as the Unicode C0 controls specified value: 0D hexadecimal (13 decimal). From your keyboard, a key entry sequence of CNTL M may be used to obtain the required character for a carriage return when using certain terminal emulator programs.
6. ' ' represents a space. Do not enter ' \_ ' (an underscore character) from your keyboard. Instead, press the space bar on your keyboard.
7. All commands sent to the module start with a '!' character (21 hex), and all normal responses from the module start with a '\*' character (2A hex). Error responses start with a '?'.  
Error responses start with a '?'.
8. A valid address must be used [Factory default = 1]. The IGM402 will not respond to a command with an invalid address.
9. RS485 Command Protocol Summary:

The command protocol for the IGM402 has the following format:

Command: <!><addr><cmd><data><CRC>

Response: <\*><addr><cmd><data><CRC>

The <data> portion of the command or response can be multiple bytes in length, depending upon the command byte (<cmd>) sent. Do not include the '<' or '>' within the message string. They are used in the context of these instructions to delineate between various bytes within the serial data string.

The Cycle Redundancy Check <CRC> is calculated for each message as follows:

```
// *ptr is a pointer to the message to be sent.
// Length is the length of the message.
char Calculate_CRC8(char *ptr, char Length)
{
    char CRC_Value;
    char Counter;
    char BitCounter;
    char XOR_Byte;
    char TransmitByte;

    // Initialize the local variable.
    CRC_Value = 0xFF;

    // Calculate the CRC.
    for(Counter = 0; Counter < Length; Counter++)
    {
        TransmitByte = *ptr;
        ptr++;
        BitCounter = 8;

        while(BitCounter != 0)
        {
            BitCounter--;
            XOR_Byte = TransmitByte ^ CRC_Value;

            if((XOR_Byte & 0x80) != 0)
            {
                CRC_Value ^= 0x0E;
                CRC_Value <<= 1;
                CRC_Value |= 1;
            }
            else
            {
                CRC_Value <<= 1;
            }

            // Left shift the calculation byte.
            TransmitByte <<= 1;
        }
    }

    // Return the calculated CRC value.
    return(CRC_Value);
}
```

This code is written in the 'C' language. Contact InstruTech technical support for code written for Visual Basic.

**Additional notes when using the BINARY protocol:**

As previously noted we recommend using the ASCII instead of Binary protocol whenever possible. However, if you must use the BINARY protocol, then there are a few things that should be noted when writing code to communicate with the device.

1. The length of the message sent to the unit is always the same as the length of the response to the message (although, individual commands have different lengths), i.e., length of response = length of command.
2. The messages sent to the unit and received from the unit are sent in hexadecimal, and not their character representations. This means that a character based application such as Hyperterminal® cannot be used. Applications such as these send a value such as zero as 30 hex, and not at 00 hex.
3. The start character for any message sent to the unit is a '!' or 21 hex.
4. The start character for any response to a message is a '\*' or 2A hex.
5. The data part of the message sent to the unit does not matter. This portion of the message is ignored by the receiving unit. It is recommended that these bytes be set to zero prior to sending the message to the unit.
6. The data part of the responses are NOT ASCII characters. These are actual variable values that are of type char, float, or long. This shortens the messages and simplifies the code written by the customer by not having to convert from ASCII characters to typed values and back again.
7. The Cyclic Redundancy Check (CRC) is calculated using the routine shown in the previous pages in [section 8.1](#) of the User Manual. The length of the message is the number of bytes beginning at the "start" character, ending with the last byte of the data, and does not include the byte that will contain the CRC. The checksum (CRC) is calculated on all the characters in the command/response string excluding the CRC itself.

**Example of actual data bytes sent and received for a 'READ IG PRESSURE ONLY' command:**

(This is done with the filament off)

**SENT:**

Byte 0: '!' (0x21) (start character)  
Byte 1: 1 (0x01) (address)  
Byte 2: 2 (0x02) (command byte for READ IG PRESSURE)  
Byte 3: 0 (0x00) (don't care units)  
Byte 4: 0 (0x00) (don't care data 1)  
Byte 5: 0 (0x00) (don't care data 2)  
Byte 6: 0 (0x00) (don't care data 3)  
Byte 7: 0 (0x00) (don't care data 4)  
Byte 8: 183 (0xB7) (CRC)

**RECEIVED:**

Byte 0: '\*' (0x2A) (start character)  
Byte 1: 1 (0x01) (address)  
Byte 2: 2 (0x02) (command byte for READ IG PRESSURE)  
Byte 3: 0 (0x00) (units; 0 = Torr, 1 = PASCALS, 2 = mBAR)  
Byte 4: 0 (0x00) (floating point byte 1)  
Byte 5: 0 (0x00) (floating point byte 2)  
Byte 6: 0 (0x00) (floating point byte 3)  
Byte 7: 0 (0x00) (floating point byte 4)  
Byte 8: 148 (0x94) (CRC)

**8.2 RS485 Command Protocol Summary - BINARY Protocol with CRC8**

<b>COMMAND</b>	<b>BRIEF DESCRIPTION</b>	<b>COMMAND SYNTAX</b>	<b>RESPONSE</b>
READ ALL PRESSURES	Read the current pressure for IG, CG1, and CG2. The returned values are in floating point.  Message Length: 17 bytes	! <i>&lt;01&gt;&lt;00&gt;&lt;xx&gt;&lt;xx&gt;&lt;xx&gt;&lt;xx&gt;</i> <i>&lt;xx&gt;&lt;xx&gt;&lt;xx&gt;&lt;xx&gt;&lt;xx&gt;</i> <i>&lt;xx&gt;&lt;xx&gt;&lt;xx&gt;&lt;xx&gt;&lt;CRC&gt;</i>  <i>&lt;cmd&gt;: 0x00</i>  <i>&lt;xx&gt;: represents the floating point value place holder.</i>	<i>*&lt;01&gt;&lt;00&gt;&lt;uu&gt;&lt;rr&gt;&lt;rr&gt;</i> <i>&lt;rr&gt;&lt;rr&gt;&lt;yy&gt;&lt;yy&gt;&lt;yy&gt;</i> <i>&lt;yy&gt;&lt;zz&gt;&lt;zz&gt;&lt;zz&gt;&lt;zz&gt;</i> <i>&lt;CRC&gt;</i> <i>&lt;uu&gt;: pressure units</i> <i>&lt;rr&gt;: IG float value</i> <i>&lt;yy&gt;: CG1 float value</i> <i>&lt;zz&gt;: CG2 float value</i>
READ CG PRESSURES	Read the current pressure for CG1 and CG2. The returned values are in floating point.  Message Length: 13 bytes	! <i>&lt;01&gt;&lt;01&gt;&lt;xx&gt;&lt;xx&gt;&lt;xx&gt;&lt;xx&gt;</i> <i>&lt;xx&gt;&lt;xx&gt;&lt;xx&gt;&lt;xx&gt;&lt;xx&gt;</i> <i>&lt;CRC&gt;</i>  <i>&lt;cmd&gt;: 0x01</i>  <i>&lt;xx&gt;: represents the floating point value place holder.</i>	<i>*&lt;01&gt;&lt;01&gt;&lt;uu&gt;&lt;yy&gt;&lt;yy&gt;</i> <i>&lt;yy&gt;&lt;yy&gt;&lt;zz&gt;&lt;zz&gt;&lt;zz&gt;</i> <i>&lt;zz&gt;&lt;CRC&gt;</i>  <i>&lt;uu&gt;: pressure units</i> <i>&lt;yy&gt;: CG1 float value</i> <i>&lt;zz&gt;: CG2 float value</i>
READ IG PRESSURE ONLY	Read the current pressure for the IG. The returned value is in floating point.  Message Length: 9 bytes	! <i>&lt;01&gt;&lt;02&gt;&lt;xx&gt;&lt;xx&gt;&lt;xx&gt;&lt;xx&gt;</i> <i>&lt;xx&gt;&lt;CRC&gt;</i>  <i>&lt;cmd&gt;: 0x02</i>  <i>&lt;xx&gt;: represents the floating point value place holder.</i>	<i>*&lt;01&gt;&lt;02&gt;&lt;uu&gt;&lt;yy&gt;&lt;yy&gt;</i> <i>&lt;yy&gt;&lt;yy&gt;&lt;CRC&gt;</i>  <i>&lt;yy&gt;: represents the four byte floating point value.</i> <i>&lt;uu&gt;: pressure units</i>
READ CG1 PRESSURE ONLY	Read the current pressure for the CG1. The returned value is in floating point.  Message Length: 9 bytes	! <i>&lt;01&gt;&lt;03&gt;&lt;xx&gt;&lt;xx&gt;&lt;xx&gt;&lt;xx&gt;</i> <i>&lt;xx&gt;&lt;CRC&gt;</i>  <i>&lt;cmd&gt;: 0x03</i>  <i>&lt;xx&gt;: represents the floating point value place holder.</i>	<i>*&lt;01&gt;&lt;03&gt;&lt;uu&gt;&lt;yy&gt;&lt;yy&gt;</i> <i>&lt;yy&gt;&lt;yy&gt;&lt;CRC&gt;</i>  <i>&lt;yy&gt;: represents the four byte floating point value.</i> <i>&lt;uu&gt;: pressure units</i>
READ CG2 PRESSURE ONLY	Read the current pressure for the CG2. The returned value is in floating point.  Message Length: 9 bytes	! <i>&lt;01&gt;&lt;04&gt;&lt;xx&gt;&lt;xx&gt;&lt;xx&gt;&lt;xx&gt;</i> <i>&lt;xx&gt;&lt;CRC&gt;</i>  <i>&lt;cmd&gt;: 0x04</i>  <i>&lt;xx&gt;: represents the floating point value place holder.</i>	<i>*&lt;01&gt;&lt;04&gt;&lt;uu&gt;&lt;yy&gt;&lt;yy&gt;</i> <i>&lt;yy&gt;&lt;yy&gt;&lt;CRC&gt;</i>  <i>&lt;yy&gt;: represents the four byte floating point value.</i> <i>&lt;uu&gt;: pressure units</i>
READ ION GAUGE STATUS	Determine if the ion gauge is on or off.  Message Length: 5 bytes	! <i>&lt;01&gt;&lt;15&gt;&lt;xx&gt;&lt;CRC&gt;</i>  <i>&lt;cmd&gt;: 0x15</i>  <i>&lt;xx&gt;: represents the byte value place holder.</i>	<i>ON:</i> <i>*&lt;01&gt;&lt;15&gt;&lt;01&gt;&lt;CRC&gt;</i>  <i>OFF:</i> <i>*&lt;01&gt;&lt;15&gt;&lt;00&gt;&lt;CRC&gt;</i>
TURN ON THE ION GAUGE	Turn ON the ion gauge module.  Message Length: 5 bytes	! <i>&lt;01&gt;&lt;05&gt;&lt;xx&gt;&lt;CRC&gt;</i>  <i>&lt;cmd&gt;: 0x05</i>  <i>&lt;xx&gt;: represents the byte value place holder.</i>	<i>ON:</i> <i>*&lt;01&gt;&lt;05&gt;&lt;01&gt;&lt;CRC&gt;</i>

<b>COMMAND</b>	<b>BRIEF DESCRIPTION</b>	<b>COMMAND SYNTAX</b>	<b>RESPONSE</b>
TURN OFF THE ION GAUGE	Turn OFF the ion gauge module.  Message Length: 5 bytes	! <i>&lt;01&gt;&lt;06&gt;&lt;xx&gt;&lt;CRC&gt;</i>  <cmd>: 0x06  <xx>: represents the byte value place holder.	* <i>&lt;01&gt;&lt;06&gt;&lt;00&gt;&lt;&lt;CRC&gt;</i>
READ ION GAUGE EMISSION CURRENT	Gets the emission current that the ion gauge is currently set to operate at.  Message Length: 5 bytes	! <i>&lt;01&gt;&lt;1B&gt;&lt;xx&gt;&lt;CRC&gt;</i>  <cmd>: 0x1B  <xx>: represents the byte value place holder.	100uA: * <i>&lt;01&gt;&lt;1B&gt;&lt;64&gt;&lt;CRC&gt;</i>  4mA: * <i>&lt;01&gt;&lt;1B&gt;&lt;04&gt;&lt;CRC&gt;</i>
SET ION GAUGE EMISSION CURRENT	Set the ion gauge module emission current.  100uA: 0x64 4mA: 0x04  Message Length: 5 bytes	100uA: ! <i>&lt;01&gt;&lt;0B&gt;&lt;64&gt;&lt;CRC&gt;</i>  4mA: ! <i>&lt;01&gt;&lt;0B&gt;&lt;04&gt;&lt;CRC&gt;</i>  <cmd>: 0x0B	100uA: * <i>&lt;01&gt;&lt;0B&gt;&lt;64&gt;&lt;CRC&gt;</i>  4mA: * <i>&lt;01&gt;&lt;0B&gt;&lt;04&gt;&lt;CRC&gt;</i>
READ ION GAUGE FILAMENT	Determine which ion gauge filament is being used.  Message Length: 5 bytes	! <i>&lt;01&gt;&lt;0C&gt;&lt;xx&gt;&lt;CRC&gt;</i>  <cmd>: 0x0C  <xx>: represents the byte value place holder.	FIL 1: * <i>&lt;01&gt;&lt;0C&gt;&lt;01&gt;&lt;CRC&gt;</i>  FIL 2: * <i>&lt;01&gt;&lt;0C&gt;&lt;02&gt;&lt;CRC&gt;</i>
SET ION GAUGE FILAMENT	Set which ion gauge filament is to be used.  FIL 1: 0x01 FIL 2: 0x02  Message Length: 5 bytes	FIL 1: ! <i>&lt;01&gt;&lt;24&gt;&lt;01&gt;&lt;CRC&gt;</i>  FIL 2: ! <i>&lt;01&gt;&lt;24&gt;&lt;02&gt;&lt;CRC&gt;</i>  <cmd>: 0x24	FIL 1: * <i>&lt;01&gt;&lt;24&gt;&lt;01&gt;&lt;CRC&gt;</i>  FIL 2: * <i>&lt;01&gt;&lt;24&gt;&lt;02&gt;&lt;CRC&gt;</i>
READ ION GAUGE OVER-PRESSURE 100 μA	Determine the pressure value when the ion gauge will turn off at 100 μA emission current.  Message Length: 8 bytes	! <i>&lt;01&gt;&lt;25&gt;&lt;xx&gt;&lt;xx&gt;&lt;xx&gt;&lt;xx&gt;&lt;CRC&gt;</i>  <cmd>: 0x25  <xx>: represents the floating point value place holder.	* <i>&lt;01&gt;&lt;25&gt;&lt;yy&gt;&lt;yy&gt;&lt;yy&gt;&lt;yy&gt;&lt;CRC&gt;</i>  <yy>: represents the four byte floating point value.
SET ION GAUGE OVER-PRESSURE 100 μA	Set the pressure value when the ion gauge will turn off at 100 μA emission current.  Message Length: 8 bytes	! <i>&lt;01&gt;&lt;0D&gt;&lt;xx&gt;&lt;xx&gt;&lt;xx&gt;&lt;xx&gt;&lt;CRC&gt;</i>  <cmd>: 0x0D  <xx>: represents the four byte floating point value.	* <i>&lt;01&gt;&lt;0D&gt;&lt;xx&gt;&lt;xx&gt;&lt;xx&gt;&lt;xx&gt;&lt;CRC&gt;</i>  <xx>: represents the four byte floating point value.

<b>COMMAND</b>	<b>BRIEF DESCRIPTION</b>	<b>COMMAND SYNTAX</b>	<b>RESPONSE</b>
SET UNIT ADDRESS	Set the address of the unit. <sup>(1)</sup>  Message Length: 5 bytes	! <i>&lt;01&gt;&lt;38&gt;&lt;xx&gt;&lt;CRC&gt;</i>  <cmd>: 0x38  <xx>: represents the address offset value.	* <i>&lt;01&gt;&lt;38&gt;&lt;xx&gt;&lt;CRC&gt;</i>
SET UNIT ADDRESS OFFSET	Set the address offset of the unit. <sup>(1)</sup>  Message Length: 5 bytes	! <i>&lt;01&gt;&lt;39&gt;&lt;xx&gt;&lt;CRC&gt;</i>  <cmd>: 0x39  <xx>: represents the address offset value.	* <i>&lt;01&gt;&lt;39&gt;&lt;xx&gt;&lt;CRC&gt;</i>  <xx>: represents the address offset value.
READ RELAY I HIGH TRIP POINT	Get the pressure when Relay I will turn off.  Message Length: 8 bytes	! <i>&lt;01&gt;&lt;26&gt;&lt;xx&gt;&lt;xx&gt;&lt;xx&gt;&lt;xx&gt;&lt;CRC&gt;</i>  <cmd>: 0x26  <xx>: represents the four byte floating point value place holder.	* <i>&lt;01&gt;&lt;26&gt;&lt;yy&gt;&lt;yy&gt;&lt;yy&gt;&lt;yy&gt;&lt;CRC&gt;</i>  <yy>: represents the four byte floating point value.
SET RELAY I HIGH TRIP POINT	Set the pressure when Relay I will turn off.  Message Length: 8 bytes	! <i>&lt;01&gt;&lt;0F&gt;&lt;xx&gt;&lt;xx&gt;&lt;xx&gt;&lt;xx&gt;&lt;CRC&gt;</i>  <cmd>: 0x0F  <xx>: represents the four byte floating point value.	* <i>&lt;01&gt;&lt;0F&gt;&lt;xx&gt;&lt;xx&gt;&lt;xx&gt;&lt;xx&gt;&lt;CRC&gt;</i>
READ RELAY I LOW TRIP POINT	Get the pressure when Relay I will turn on.  Message Length: 8 bytes	! <i>&lt;01&gt;&lt;27&gt;&lt;xx&gt;&lt;xx&gt;&lt;xx&gt;&lt;xx&gt;&lt;CRC&gt;</i>  <cmd>: 0x27  <xx>: represents the four byte floating point value place holder.	* <i>&lt;01&gt;&lt;27&gt;&lt;yy&gt;&lt;yy&gt;&lt;yy&gt;&lt;yy&gt;&lt;CRC&gt;</i>  <yy>: represents the four byte floating point value.
SET RELAY I LOW TRIP POINT	Set the pressure when Relay I will turn on  Message Length: 8 bytes	! <i>&lt;01&gt;&lt;10&gt;&lt;xx&gt;&lt;xx&gt;&lt;xx&gt;&lt;xx&gt;&lt;CRC&gt;</i>  <cmd>: 0x10  <xx>: represents the four byte floating point value.	* <i>&lt;01&gt;&lt;10&gt;&lt;xx&gt;&lt;xx&gt;&lt;xx&gt;&lt;xx&gt;&lt;CRC&gt;</i>
READ RELAY A HIGH TRIP POINT	Get the pressure when Relay A will turn off.  Message Length: 8 bytes	! <i>&lt;01&gt;&lt;28&gt;&lt;xx&gt;&lt;xx&gt;&lt;xx&gt;&lt;xx&gt;&lt;CRC&gt;</i>  <cmd>: 0x28  <xx>: represents the four byte floating point value place holder.	* <i>&lt;01&gt;&lt;28&gt;&lt;yy&gt;&lt;yy&gt;&lt;yy&gt;&lt;yy&gt;&lt;CRC&gt;</i>  <yy>: represents the four byte floating point value.

<sup>(1)</sup> Commands marked with a (1) under the “BRIEF DESCRIPTION” column will not take effect until after RESET command is sent or power is cycled.

<b>COMMAND</b>	<b>BRIEF DESCRIPTION</b>	<b>COMMAND SYNTAX</b>	<b>RESPONSE</b>
SET RELAY A HIGH TRIP POINT	Set the pressure when Relay A will turn off.  Message Length: 8 bytes	! <i>&lt;01&gt;&lt;11&gt;&lt;xx&gt;&lt;xx&gt;&lt;xx&gt;&lt;xx&gt;&lt;CRC&gt;</i>  <cmd>: 0x11  <xx>: represents the four byte floating point value.	* <i>&lt;01&gt;&lt;11&gt;&lt;xx&gt;&lt;xx&gt;&lt;xx&gt;</i> <i>&lt;xx&gt;&lt;CRC&gt;</i>
READ RELAY A LOW TRIP POINT	Get the pressure when Relay A will turn on.  Message Length: 8 bytes	! <i>&lt;01&gt;&lt;29&gt;&lt;xx&gt;&lt;xx&gt;&lt;xx&gt;&lt;xx&gt;&lt;CRC&gt;</i>  <cmd>: 0x29  <xx>: represents the four byte floating point value place holder.	* <i>&lt;01&gt;&lt;29&gt;&lt;yy&gt;&lt;yy&gt;&lt;yy&gt;</i> <i>&lt;yy&gt;&lt;CRC&gt;</i>  <yy>: represents the four byte floating point value.
SET RELAY A LOW TRIP POINT	Set the pressure when Relay A will turn on.  Message Length: 8 bytes	! <i>&lt;01&gt;&lt;12&gt;&lt;xx&gt;&lt;xx&gt;&lt;xx&gt;&lt;xx&gt;&lt;CRC&gt;</i>  <cmd>: 0x12  <xx>: represents the four byte floating point value.	* <i>&lt;01&gt;&lt;12&gt;&lt;xx&gt;&lt;xx&gt;&lt;xx&gt;</i> <i>&lt;xx&gt;&lt;CRC&gt;</i>
READ RELAY B HIGH TRIP POINT	Get the pressure when Relay B will turn off.  Message Length: 8 bytes	! <i>&lt;01&gt;&lt;2A&gt;&lt;xx&gt;&lt;xx&gt;&lt;xx&gt;&lt;xx&gt;&lt;CRC&gt;</i>  <cmd>: 0x2A  <xx>: represents the four byte floating point value place holder.	* <i>&lt;01&gt;&lt;2A&gt;&lt;yy&gt;&lt;yy&gt;&lt;yy&gt;</i> <i>&lt;yy&gt;&lt;CRC&gt;</i>  <yy>: represents the four byte floating point value.
SET RELAY B HIGH TRIP POINT	Set the pressure when Relay B will turn off.  Message Length: 8 bytes	! <i>&lt;01&gt;&lt;13&gt;&lt;xx&gt;&lt;xx&gt;&lt;xx&gt;&lt;xx&gt;&lt;CRC&gt;</i>  <cmd>: 0x13  <xx>: represents the four byte floating point value.	* <i>&lt;01&gt;&lt;13&gt;&lt;xx&gt;&lt;xx&gt;&lt;xx&gt;</i> <i>&lt;xx&gt;&lt;CRC&gt;</i>
READ RELAY B LOW TRIP POINT	Get the pressure when Relay B will turn on.  Message Length: 8 bytes	! <i>&lt;01&gt;&lt;2B&gt;&lt;xx&gt;&lt;xx&gt;&lt;xx&gt;&lt;xx&gt;&lt;CRC&gt;</i>  <cmd>: 0x2B  <xx>: represents the four byte floating point value place holder.	* <i>&lt;01&gt;&lt;2B&gt;&lt;yy&gt;&lt;yy&gt;&lt;yy&gt;</i> <i>&lt;yy&gt;&lt;CRC&gt;</i>  <yy>: represents the four byte floating point value.
SET RELAY B LOW TRIP POINT	Set the pressure when Relay B will turn on.  Message Length: 8 bytes	! <i>&lt;01&gt;&lt;14&gt;&lt;xx&gt;&lt;xx&gt;&lt;xx&gt;&lt;xx&gt;&lt;CRC&gt;</i>  <cmd>: 0x14 <xx>: represents the four byte floating point value.	* <i>&lt;01&gt;&lt;14&gt;&lt;xx&gt;&lt;xx&gt;&lt;xx&gt;</i> <i>&lt;xx&gt;&lt;CRC&gt;</i>

<b>COMMAND</b>	<b>BRIEF DESCRIPTION</b>	<b>COMMAND SYNTAX</b>	<b>RESPONSE</b>
READ ION GAUGE DEGAS STATUS	Get the degas status of the ion gauge module.  ON: 1 OFF: 0  Message Length: 5 bytes	! <i>&lt;01&gt;&lt;18&gt;&lt;xx&gt;&lt;CRC&gt;</i>  <cmd>: 0x18  <xx>: represents the byte value place holder.	ON: * <i>&lt;01&gt;&lt;18&gt;&lt;01&gt;&lt;CRC&gt;</i>  OFF: * <i>&lt;01&gt;&lt;18&gt;&lt;00&gt;&lt;CRC&gt;</i>
TURN ION GAUGE DEGAS ON	Turn on the ion gauge degas  Message Length: 5 bytes	! <i>&lt;01&gt;&lt;19&gt;&lt;xx&gt;&lt;CRC&gt;</i>  <cmd>: 0x19  <xx>: represents the byte value place holder.	* <i>&lt;01&gt;&lt;19&gt;&lt;01&gt;&lt;CRC&gt;</i>
TURN ION GAUGE DEGAS OFF	Turn off the ion gauge degas  Message Length: 5 bytes	! <i>&lt;01&gt;&lt;1A&gt;&lt;xx&gt;&lt;CRC&gt;</i>  <cmd>: 0x1A  <xx>: represents the byte value place holder.	* <i>&lt;01&gt;&lt;1A&gt;&lt;00&gt;&lt;CRC&gt;</i>
READ ION GAUGE CONTROL STATUS	Get the ion gauge control status. These are the semaphores that communicate status and errors in two bytes.  Message Length: 6 bytes	! <i>&lt;01&gt;&lt;1C&gt;&lt;xx&gt;&lt;xx&gt;&lt;CRC&gt;</i>  <cmd>: 0x1C  <xx>: represents the byte value place holder.	* <i>&lt;01&gt;&lt;1C&gt;&lt;Byte 1&gt;&lt;Byte 2&gt;&lt;CRC&gt;</i>  Byte 1: hgfdcba a: Degas Status b: IG On/Off c: Emission Current d: Emission Control Failure e: Filament Broken f: Degas Failure g: Over-Pressure Failure h: Ion Current Failure  Byte 2: hgfdcba a: Filament Over-voltage b: Filament Over-Power c: Dual Convection Control d: Front Panel Control e: Quick Vent Enabled f: NA g: NA h: NA
SET FACTORY DEFAULTS	Set the unit back to the factory defaults. <sup>(1)</sup>  Message Length: 5 bytes	! <i>&lt;01&gt;&lt;1F&gt;&lt;xx&gt;&lt;CRC&gt;</i>  <cmd>: 0x1F  <xx>: represents the byte value place holder.	* <i>&lt;01&gt;&lt;1F&gt;&lt;01&gt;&lt;CRC&gt;</i>



COMMAND	BRIEF DESCRIPTION	COMMAND SYNTAX	RESPONSE
SET COMMS BAUD RATE	Set the communications baud rate for the unit. <sup>(1)</sup>  Message Length: 5 bytes	! <i>&lt;01&gt;&lt;20&gt;&lt;xx&gt;&lt;CRC&gt;</i>  <cmd>: 0x20  <xx>: represents the byte value as follows for various baud rates: 00: 300 01: 600 02: 1200 03: 2400 04: 4800 05: 9600 06: 14,400 07: 19,200 08: 28,800 09: 38,400 0A: 57,600	* <i>&lt;01&gt;&lt;20&gt;&lt;xx&gt;&lt;CRC&gt;</i>
RESET UNIT	Reset the unit as if power has been cycled from off to on.  Message Length: 5 bytes	! <i>&lt;01&gt;&lt;22&gt;&lt;xx&gt;&lt;CRC&gt;</i>  <cmd>: 0x22  <xx>: represents the byte	No response from unit.
READ CG1 VACUUM SETTING VALUE	Gets the CG1 vacuum pressure setting.  Message Length: 8 bytes	! <i>&lt;01&gt;&lt;2D&gt;&lt;xx&gt;&lt;xx&gt;&lt;xx&gt;&lt;xx&gt;&lt;CRC&gt;</i>  <cmd>: 0x2D  <xx>: represents the four byte floating point value place holder.	* <i>&lt;01&gt;&lt;2D&gt;&lt;yy&gt;&lt;yy&gt;&lt;yy&gt;&lt;yy&gt;&lt;CRC&gt;</i>  <yy>: represents the four byte floating point value.
SET CG1 VACUUM SETTING VALUE	Sets the CG1 vacuum pressure setting.  Message Length: 8 bytes	! <i>&lt;01&gt;&lt;2C&gt;&lt;xx&gt;&lt;xx&gt;&lt;xx&gt;&lt;xx&gt;&lt;CRC&gt;</i>  <cmd>: 0x2C  <xx>: represents the four byte floating point value.	* <i>&lt;01&gt;&lt;2C&gt;&lt;xx&gt;&lt;xx&gt;&lt;xx&gt;&lt;xx&gt;&lt;CRC&gt;</i>
READ CG2 VACUUM SETTING VALUE	Gets the CG2 vacuum pressure setting.  Message Length: 8 bytes	! <i>&lt;01&gt;&lt;2F&gt;&lt;xx&gt;&lt;xx&gt;&lt;xx&gt;&lt;xx&gt;&lt;CRC&gt;</i>  <cmd>: 0x2F  <xx>: represents the four byte floating point value place holder.	* <i>&lt;01&gt;&lt;2F&gt;&lt;yy&gt;&lt;yy&gt;&lt;yy&gt;&lt;yy&gt;&lt;CRC&gt;</i>  <yy>: represents the four byte floating point value.

<sup>(1)</sup> Commands marked with a (1) under the “BRIEF DESCRIPTION” column will not take effect until after RESET command is sent or power is cycled.

<b>COMMAND</b>	<b>BRIEF DESCRIPTION</b>	<b>COMMAND SYNTAX</b>	<b>RESPONSE</b>
SET CG2 VACUUM SETTING VALUE	Sets the CG2 vacuum pressure setting.  Message Length: 8 bytes	! <i>&lt;01&gt;&lt;2E&gt;&lt;xx&gt;&lt;xx&gt;&lt;xx&gt;&lt;xx&gt;&lt;CRC&gt;</i>  <cmd>: 0x2E  <xx>: represents the four byte floating point value.	* <i>&lt;01&gt;&lt;2E&gt;&lt;xx&gt;&lt;xx&gt;&lt;xx&gt;&lt;xx&gt;&lt;CRC&gt;</i>
READ CG1 ATMOSPHERE SETTING VALUE	Gets the CG1 atmosphere pressure setting.  Message Length: 8 bytes	! <i>&lt;01&gt;&lt;31&gt;&lt;xx&gt;&lt;xx&gt;&lt;xx&gt;&lt;xx&gt;&lt;CRC&gt;</i>  <cmd>: 0x31  <xx>: represents the four byte floating point value place holder.	* <i>&lt;01&gt;&lt;31&gt;&lt;yy&gt;&lt;yy&gt;&lt;yy&gt;&lt;yy&gt;&lt;CRC&gt;</i>  <xyyx>: represents the four byte floating point value.
SET CG1 ATMOSPHERE SETTING VALUE	Sets the CG1 atmosphere pressure setting.  Message Length: 8 bytes	! <i>&lt;01&gt;&lt;30&gt;&lt;xx&gt;&lt;xx&gt;&lt;xx&gt;&lt;xx&gt;&lt;CRC&gt;</i>  <cmd>: 0x30  <xx>: represents the four byte floating point value.	* <i>&lt;01&gt;&lt;30&gt;&lt;xx&gt;&lt;xx&gt;&lt;xx&gt;&lt;xx&gt;&lt;CRC&gt;</i>
READ CG2 ATMOSPHERE SETTING VALUE	Gets the CG2 atmosphere pressure setting.  Message Length: 8 bytes	! <i>&lt;01&gt;&lt;33&gt;&lt;xx&gt;&lt;xx&gt;&lt;xx&gt;&lt;xx&gt;&lt;CRC&gt;</i>  <cmd>: 0x33  <xx>: represents the four byte floating point value place holder.	* <i>&lt;01&gt;&lt;33&gt;&lt;yy&gt;&lt;yy&gt;&lt;yy&gt;&lt;yy&gt;&lt;CRC&gt;</i>  <xyyx>: represents the four byte floating point value.
SET CG2 ATMOSPHERE SETTING VALUE	Sets the CG2 atmosphere pressure setting.  Message Length: 8 bytes	! <i>&lt;01&gt;&lt;32&gt;&lt;xx&gt;&lt;xx&gt;&lt;xx&gt;&lt;xx&gt;&lt;CRC&gt;</i>  <cmd>: 0x32  <xx>: represents the four byte floating point value.	* <i>&lt;01&gt;&lt;32&gt;&lt;xx&gt;&lt;xx&gt;&lt;xx&gt;&lt;xx&gt;&lt;CRC&gt;</i>
READ CG1 ANALOG OUTPUT TYPE	Get the type of analog output setup for CG1  Message Length: 5 bytes	! <i>&lt;01&gt;&lt;35&gt;&lt;xx&gt;&lt;CRC&gt;</i>  <cmd>: 0x35  <xx>: represents the byte value place holder.	* <i>&lt;01&gt;&lt;35&gt;&lt;xx&gt;&lt;CRC&gt;</i>  <yy>: represents the byte value as follows: 00: Non-Linear 01: Log-Linear
SET CG1 ANALOG OUTPUT TYPE	Set the type of analog output setup for CG1  Message Length: 5 bytes	! <i>&lt;01&gt;&lt;34&gt;&lt;xx&gt;&lt;CRC&gt;</i>  <cmd>: 0x34  <xx>: represents the byte value as follows: 00: Non-Linear 01: Log-Linear	* <i>&lt;01&gt;&lt;34&gt;&lt;xx&gt;&lt;CRC&gt;</i>

<b>COMMAND</b>	<b>BRIEF DESCRIPTION</b>	<b>COMMAND SYNTAX</b>	<b>RESPONSE</b>
READ CG2 ANALOG OUTPUT TYPE	Get the type of analog output setup for CG2  Message Length: 5 bytes	<i>!</i> <01><37><xx><CRC>  <cmd>: 0x37  <xx>: represents the byte value place holder.	*<01><37><xx><CRC>  <yy>: represents the byte value as follows: 00: Non-Linear 01: Log-Linear
SET CG2 ANALOG OUTPUT TYPE	Set the type of analog output setup for CG2  Message Length: 5 bytes	<i>!</i> <01><36><xx><CRC>  <cmd>: 0x36  <xx>: represents the byte value as follows: 00: Non-Linear 01: Log-Linear	*<01><36><xx><CRC>
READ 100 μA TURN ON PRESSURE	Read the pressure where CG1 will turn on IG  Message Length: 8 bytes	<i>!</i> <01><43><xx><xx><xx><xx><CRC>  <cmd>: 0x43  <xx> Represents a byte value place holder	*<01><43><yy><yy><yy><yy><CRC>  <yy> Represents a byte value place holder for a floating point number
SET 100 μA TURN ON PRESSURE	Set the pressure where CG1 will turn on IG  Message Length: 8 bytes	<i>!</i> <01><44><xx><xx><xx><xx><CRC>  <cmd>: 0x44  <xx> Represents a byte value place holder	*<01><44><yy><yy><yy><yy><CRC>  <yy> Represents a byte value place holder for a floating point number

It is recommended that if you are not familiar with the use of the BINARY protocol described in this section, please consider using the ASCII type protocol described in the following sections 8.3 and 8.4. The BINARY protocol described above is a sophisticated serial communication protocol used only when control system designs require the use of cyclic redundancy checking (transmission error checking) of the commands and responses sent and received between master and slave devices. Using the BINARY protocol requires special programming knowledge and capability.

### 8.3 Device Specific Serial Communication Info - ASCII Protocol

The standard IGM402 model provides RS485 serial communications with capability for the user to select the type of protocol desired. The device default setting is 'BINARY'. To set the IGM402 to be used with RS485 ASCII protocol, see – **FORMAT** at [section 5.8.5 SETUP COMMS](#).

The following information and the RS485 command protocol summary listed on the following page can be used to establish serial communications with the device using ASCII protocol.

1. Default settings are **19,200** baud rate, **8** data bits, **No Parity**, **1** stop bit [Factory default; **19,200, 8, N, 1**].
2. The baud rate can be set to various values using the front panel soft-keys. See [SET COMMS BAUD RATE](#) in section 8.2 RS485 Command Protocol Summary table for commonly used baud rates. Baud rate used by device (slave) must be the same as used by the host (master).
3. Minimum interval between commands sent out over the RS485 bus is 50 msec.
4. The stop bit is always 1.
5. All Responses are 13 characters long.
6. 'xx' is the RS485 node address of the device (00 thru FF).
7. <CR> represents a carriage return, a non-printable character. Do not enter <CR> from your keyboard. A carriage return, non-printable character may be entered as the Unicode CO controls specified value: OD hexadecimal (13 decimal). From your keyboard, a key entry sequence of CNTL-M may be used to obtain the required character for a carriage return when using certain terminal emulator programs.
8. '\_' represents a 'space' character. Press the space bar on your keyboard. Do not enter a '\_' (underscore) character.
9. The 'z' in the set or read/set trip point commands is a '+' or '-'. The plus (+) is the 'turns ON below' setpoint and the minus (-) is the 'turns OFF above' setpoint.
10. All commands sent to the module start with a '#' character, and all normal responses from the module start with a '\*' character. Error responses start with a '?'.
11. A valid address must be used [Factory default = 1]. The IGM402 will not respond to a command with an invalid address.
12. The command syntax examples used in the protocol summary table for ASCII are shown in scientific notation. However, floating point notation is acceptable as long as a leading digit is entered as '0.' or '1.', etc. There must be a digit to the left of the decimal point. For example, when constructing the syntax for the command to set the CGn zero value (e.g., #xxTZn\_x.xxE-pp<CR> when using scientific notation), use either #xxTZn\_0.00<CR>, or #xxTZn\_0<CR>. A simple '0' is valid for the pressure entry.

8.4 RS485 Command Protocol Summary - ASCII Protocol

COMMAND	BRIEF DESCRIPTION	COMMAND SYNTAX	RESPONSE
READ ION GAUGE PRESSURE	Read the current displayed pressure of the ion gauge in Torr	#xxRD<CR> (e.g., #01RD<CR>) where xx = the two digit address of the device (node)	*xx_y.yyEzpp<CR> where y.yy = mantissa, z = sign of the exponent, i.e., +/- and pp = the exponent. (e.g., *01_1.53E-06<CR>) When IG is off: *01_9.90E+09
READ System Pressure	Read the current IG pressure and CG pressure (IG+CG1 combined)	#xxRDS<CR> (e.g., #01RDS<CR>)	*xx_y.yyEzyy<CR> (e.g., *01_1.53E-06<CR>) When IG is off: CG only
READ CGn Pressure	Read the current pressure for CGn	#xxRDCGn<CR> where n=1 or 2 (e.g., #01RDCG1<CR>) (e.g., #01RDCG2<CR>)	*xx_y.yyEzyy <CR> (e.g., *01_7.60E+02<CR>) When CG is over-ranged or not plugged in: *01_1.01E+03<CR>
SET ADDR OFFSET	Set the communications (RS485) address offset (upper nibble) <sup>(1)</sup>	#xxSAuu<CR> (e.g., #01SA10<CR>) where uu = 00 or 10 or 20 or 30	*xx_PROGM_OK<CR>
TURN IG ON	Power up the filament and start reading pressure	#xxIG1<CR> (e.g., #01IG1<CR>)	*xx_PROGM_OK<CR> When CG controlled: ?01_INVALID_<CR> When IG error exists: ?01_INVALID_<CR>
TURN IG OFF	Turns power OFF to the filament	#xxIG0<CR> (e.g., #01IG0<CR>)	*xx_PROGM_OK<CR>  (clears any errors)
READ IG ON/OFF STATUS	Find out if filament is powered up and gauge is reading	#xxIGS<CR> (e.g., #01IGS<CR>)	*xx_0_IG_OFF<CR> *xx_1_IG_ON_<CR>
TURN DEGAS ON	Start a degas cycle	#xxDG1<CR> (e.g., #01DG1<CR>)	*xx_PROGM_OK<CR> When IG off: ?01_INVALID_<CR> When P > 5e-5: ?01_INVALID_<CR>
TURN DEGAS OFF	Stop a degas cycle	#xxDG0<CR> (e.g., #01DG0<CR>)	*xx_PROGM_OK<CR>
READ DEGAS STATUS	Find out if the module is currently degassing	#xxDGS<CR> (e.g., #01DGS<CR>)	*xx_0_DG_OFF<CR> *xx_1_DG_ON_<CR>

<b>COMMAND</b>	<b>BRIEF DESCRIPTION</b>	<b>COMMAND SYNTAX</b>	<b>RESPONSE</b>
READ EMISSION CURRENT STATUS	Read emission current setting	#xxSES<CR> (e.g., #01SES<CR>)	*xx_0.1MA_EM<CR> *xx_4.0MA_EM<CR>
SET EMISSION CURRENT	Choose emission current of 4 mA or 100 µA	#01SEy<CR> (e.g., #01SE1<CR>) for y=1=4 mA; y=0=100µA	*xx_PROGM_OK<CR>
SET FILAMENT	Choose Filament 1 or 2	#xxSFy<CR> (e.g., #01SF1<CR>) y=1 for F1; y=2 for F2	*xx_PROGM_OK<CR>
SET TRIP POINT for RELAY I (IG)	Set the 'turns on below' (+) pressure point for RLY I and set the 'turns off above' (-) pressure point for RLY I as indicated by the pressure display for the ion gauge (IG)	#xxSLzy.yyEzpp<CR> (e.g., #01SL+4.00E-06<CR>) (e.g., #01SL-5.50E-06<CR>) For the 'z' preceding the 'y.yy' value, a '+' = 'turns ON below' and a '-' = 'turns OFF above' the setpoint value for RLY I	*xx_PROGM_OK<CR>
SET TRIP POINT for RLY A	Set the 'turns on below' (+) pressure point for RLY A and set the 'turns off above' (-) pressure point for RLY A  <i>Hint: Set the 'turns off above' (-) setpoint pressure first.</i>  <i>NOTE: RLY A/B may be assigned to either CG1 or CG2 pressure readings.</i>	#xxSLAzy.yyEzpp<CR> (e.g., #01SLA+4.00E+02<CR>) (e.g., #01SLA-5.00E+02<CR>) Turn the relay OFF (-) above 500 Torr	*xx_PROGM_OK<CR>  If the 'turns off above' (-) pressure setpoint is less than the value of the 'turns on below' (+) setpoint, a syntax error of ?01 SYNTAX ER<CR> will result.
SET TRIP POINT for RLY B	Set the 'turns on below' (+) setpoint pressure for RLY B and set the 'turns off above' (-) setpoint pressure for RLY B  <i>Hint: Set the 'turns off above' (-) setpoint pressure first</i>	#xxSLBzy.yyEzpy<CR> (e.g., #01SLB+4.00E+02<CR>) Turn the relay ON (+) below 400 Torr (e.g., #01SLB-5.00E+02<CR>) Turn the relay OFF (-) above 500 Torr	*xx_PROGM_OK<CR>  If the 'turns off above' (-) pressure setpoint is less than the value of the 'turns on below' (+) setpoint, a syntax error of ?01 SYNTAX ER<CR> will result.
READ TRIP POINT for RLY I (IG)	Read the 'turns on below' (+) pressure point for relay I and read the 'turns off above' (-) pressure point for relay I	#xxRLz<CR> (e.g., #01RL+<CR>)  (e.g., #01RL-<CR>)	*xx_y.yyEzpy<CR> (e.g., *01+7.60E+02<CR>)  (e.g., *01-7.60E+02<CR>)
READ TRIP POINT for RLY A	Read the 'turns on below' (+) pressure point for relay A and read the 'turns off above' (-) pressure point for relay A	#xxRLAz<CR> (e.g., #01RLA+<CR>)  (e.g., #01RLA-<CR>)	*xx_y.yyEzpy<CR> (e.g., *01+5.60E+02<CR>)  (e.g., *01-7.60E+02<CR>)

READ TRIP POINT for RLY B	Read the 'turns on below' (+) pressure point for relay B and read the 'turns off above' (-) pressure point for relay B	#xxRLBz<CR> (e.g., #01RLB+<CR>)  (e.g., #01RLB-<CR>)	*xx_y.yyEzyy<CR> (e.g., *01+4.00E+02<CR>)  (e.g., *01-5.00E+02<CR>)
READ IG STATUS	Finds out the cause of the ion gauge (IG) shutdown <sup>(2)</sup>	#xxRS<CR> (e.g., #01RS<CR>)	*xx_00_ST_OK<CR> *xx_01_OVPRS<CR> *xx_02_EMISS<CR> *xx_08_POWER<CR> *xx_20_ION_C<CR> <sup>(3)</sup>

<sup>(1)</sup> Commands marked with a (1) under the "BRIEF DESCRIPTION" column will not take effect until after the RESET command is sent or power is cycled. This protocol was designed to be compatible with that of the Granville-Phillips® 354 Micro-Ion®.

<sup>(2)</sup> After power is cycled, the first #xxRS<CR> query will return a \*xx\_08\_POWER<CR>. A second #xxRS<CR> query will return \*xx\_00\_ST\_OK<CR>. Now, if, for example, power was cycled *and* an EMIS FAIL error occurred when a subsequent IG ON condition was attempted, the response to the #xxRS<CR> query will be the sum of the '08' for Power and '02' for EMIS FAIL in hexadecimal or '0A'. In other words, the response to the #xxRS<CR> command sent after the power cycle and emission failure events occurred will be \*xx\_0A\_EMISS<CR>.

<sup>(3)</sup> The \*xx\_20\_ION\_C<CR> response to an Ion Current failure error is not a response available with G-P Micro-Ion.

COMMAND	BRIEF DESCRIPTION	COMMAND SYNTAX	RESPONSE
SET CGn ZERO	Set the zero or vacuum calibration point for CGn where n=1=A (as used in the command syntax) for CG1, n=2=B for CG2.  Do not confuse the assignment of RLY A and RLY B with the distinction of A=CG1 and B=CG2 used here, in the command syntax.	#xxTZn_x.xxE-pp<CR> (e.g., #01TZA 0<CR>) <i>floating point notation, or</i> (e.g., #01TZB 1.00e-2<CR>) <i>scientific notation; either may be used with the ASCII format. When using float values, be sure to place a numeral in the placeholder immediately to the left of the decimal point.</i> TZn where n=A or B for CG1=A and CG2=B	*xx_PROGM_OK<CR> When P (i.e., x.xxE-pp) > 100mT: ?01_INVALID_<CR>  When requested P > 100mT: ?01_INVALID_<CR>  When requested gauge number <1 or >2: ?01_SYNTAX_ER <CR>
SET CGn SPAN	Set the span or atmosphere calibration point for CGn	#xxTSn_y.yyEzyy<CR> (e.g., #01TSA 7.60E+02) or, <i>using floating point notation:</i> (e.g., #01TSn635.0<CR>)  TSn where n=A or B for CG1=A and CG2=B	*xx_PROGM_OK<CR> When P < 400Torr: ?01_INVALID_<CR> When requested P < 400Torr: ?01_INVALID_<CR> When requested P > 1000mT: ?01_INVALID_<CR> When requested gauge number <1 or >2: ?01_SYNTAX_ER <CR>
READ SW VERSION	Read the revision number of the installed software	#xxVER<CR> (e.g., #01VER<CR>)	*xx_mmmm-vv<CR> e.g., *01_1769-103<CR>
SET FACTORY DEFAULTS	Force unit to return ALL settings back to the way the factory programmed them before shipment <sup>(1)</sup>	#xxFAC<CR> (e.g., #01FAC<CR>)	*xx_PROGM_OK<CR>

<b>COMMAND</b>	<b>BRIEF DESCRIPTION</b>	<b>COMMAND SYNTAX</b>	<b>RESPONSE</b>
SET BAUD RATE	Set the communications baud rate for RS485. <sup>(1)</sup>	#xxSByyyyy<CR> (e.g., #01SB19200<CR>)	*xx_PROGM_OK<CR>
SET PARITY	Set the communications to NO parity, 8 bits;  ODD parity, 7 bits;  EVEN parity, 7 bits for the RS485 interface <sup>(1)</sup>	#xxSPN<CR> (e.g., #01SPN<CR>) no parity, 8 bits #xxSPO<CR> (e.g., #01SPO<CR>) odd parity, 7 bits #xxSPE<CR> (e.g., #01SPE<CR>) even parity, 7 bits	*xx_PROGM_OK<CR>
UNLOCK COMM PROGRAMMING (UNL)	If the UNL command is enabled by the TLU command, the UNL command must be executed in sequence prior to the SB, SPN, SPO, and SPE commands.  Not sending the UNL will yield a response of ?xx_COMM_ERR<CR>. If UNL is not enabled, then a response would be ?xx_SYNTAX_ER<CR>	#xxUNL<CR> (e.g., #01UNL<CR>)	*xx_PROGM_OK<CR>
TOGGLE UNL FUNCTION (TLU)	The TLU command will toggle the state of the UNL function. When the response is UL_ON, then UNL is required to execute SB, SPN, SPO, and SPE. When response is UL_OFF, then UNL is not required and sending a UNL will generate a response of ?xx_SYNTAX_ER<CR>.	#xxTLU<CR> (e.g., #01TLU<CR>)	*xx_1_UL_ON_<CR> *xx_0_UL_OFF<CR>
RESET	Reset the device as if power was cycled (Required to complete some of the commands.)	#xxRST<CR> (e.g., #01RST<CR>)	No response

<sup>(1)</sup> Commands marked with a (1) under the “BRIEF DESCRIPTION” column will not take effect until after the RESET command is sent or power is cycled. This protocol was designed to be compatible with that of the Granville-Phillips® 354 Micro-Ion®.



## 9 Service

### 9.1 Calibration

Every InstruTech module is calibrated prior to shipment using nitrogen. Care should be exercised when using gases other than nitrogen (N<sub>2</sub>) / air (see [Section 7](#) titled “Using the gauge with different gases”).

### 9.2 Troubleshooting - Operation

<i>Indication</i>	<i>Possible Cause</i>	<i>Possible Solution</i>
Display is off / blank	No power  The connector may not be wired correctly	Check cable connections and verify that power is being supplied  check cable connections and verify that power is being supplied
Readings appear very different from expected pressure	Sensor not in the proper location to measure system pressure  The process gas is different from the gas (Nitrogen) used to calibrate the IGM402  Sensor has been dropped causing mechanical damage  The gauge sensor tube is contaminated  Leak in the vacuum system	Ensure the sensor is located in appropriate location  Apply gas sensitivity correction factor if applicable or select the appropriate gas from the IGM402 display menu  Replace the ion gauge transducer (IG4xy)  Degas the sensor or replace the sensor  Re-check for leak in the system. Re-check that all metal seals are used when operating below $1.0 \times 10^{-7}$ Torr
Ion gauge cannot be turned on	Pressure exceeds $1.00 \times 10^{-3}$ Torr at 4 mA emission  Pressure exceeds $5.0 \times 10^{-2}$ Torr at 0.10 ma (100 $\mu$ A) emission  Emission Control not functioning	Decrease pressure below required value  Decrease pressure below required value  Switch to the other filament replace Ion gauge sensor tube due to possible filament failure or contamination
Research Screen shows filament Voltage is present but filament current stays at 0	Filament is open	Switch to the other filament, replace sensor or electronics
Research Screen shows filament voltage and filament current are present but gauge is shutting off	Filament is contaminated or burned out	Switch to the other filament or replace sensor
Unable to initiate degas	System pressure above $5.0 \times 10^{-5}$ Torr	Decrease pressure below the required value
Voltage to filament too high	Filament contaminated or near end of its life	Switch to the other filament or replace sensor
Setpoint does not actuate	Incorrect setup	Check setpoint setup

### 9.3 Troubleshooting - Error Messages

<i>Indication</i>	<i>Possible Cause</i>	<i>Possible Solution</i>
OVERPRESSURE	The calculated pressure is greater than maximum setting for emission current. System pressure too high	Change to 100 µA emission current which will operate at higher pressures or reduce pressure
ION CUR FAIL	The Ion current (IC) is below the minimum parameter. Sensor contamination, possible coating on collector inhibiting ion collection  Electrometer failure	Determine source of contamination Replace the ion gauge transducer (IG4xy)  Contact InstruTech
EMIS FAIL	The desired emission current (IE) could not be established.  Ion gauge contamination, possible coating on filament or grid surfaces.  End of filament life  System pressure too high	Switch to 4mA emission current and attempt repeated filament starts to clean filament  Switch to second filament, degas  Replace the ion gauge transducer (IG4xy)  Reduce pressure
LV Failure	The Filament voltage could not be established. Electronics Failure	Contact InstruTech
LV OVR PWR	The power applied to the filament is at maximum without establishing an emission current	Contact InstruTech
F1 or F2 OPEN	Filament 1 or 2 is open	Switch to the other filament or replace the ion gauge transducer (IG4xy)
F1 or F2 OPEN	Faulty electronics	Replace electronics

**Note:**

Once the cause of the IG error has been determined and resolved the IG error must be cleared before the IG filament can be turned on again. The method by which the error is cleared is dependent on the IG CNTL submenu of the SETUP UNIT menu selected. The IG error can be cleared by one of the following three methods:

- 1) If Input control menu (IG CNTL) is set to DIGI (digital Input), then remove ground from PIN 1 of the analog connector. Next apply ground to Pin 1 of the analog connector to turn the IG filament on.
- 2) If Input control menu (IG CNTL) is set to RS485, then send an off command to clear the error. Next send an on command to turn the IG filament on.
- 3) If Input control menu (IG CNTL) is set to FRONT PANEL, first access the CLR IG ERROR submenu of SETUP UNIT menu. Press Enter to clear the error and exit. Next, turn on the IG filament in the FP OPERATE submenu of the SETUP UNIT menu.

#### 9.4 Troubleshooting - Filaments F1 or F2 open

If a filament is open, then trying to start the filament will result in error messages “F1 or F2 open” or similar displayed error messages. This error may be an indication of open filaments but in some cases it could also be an indication of faulty electronics.

To determine whether the problem is caused by either a failed filament or the electronics, refer to [section 9.8](#) and follow instructions to remove the ion gauge transducer from the control module. Measure the resistance (electrical continuity) of filaments 1 and 2 as shown below. A good, intact filament will indicate a resistance of 0.2 ohms on your ohmmeter.

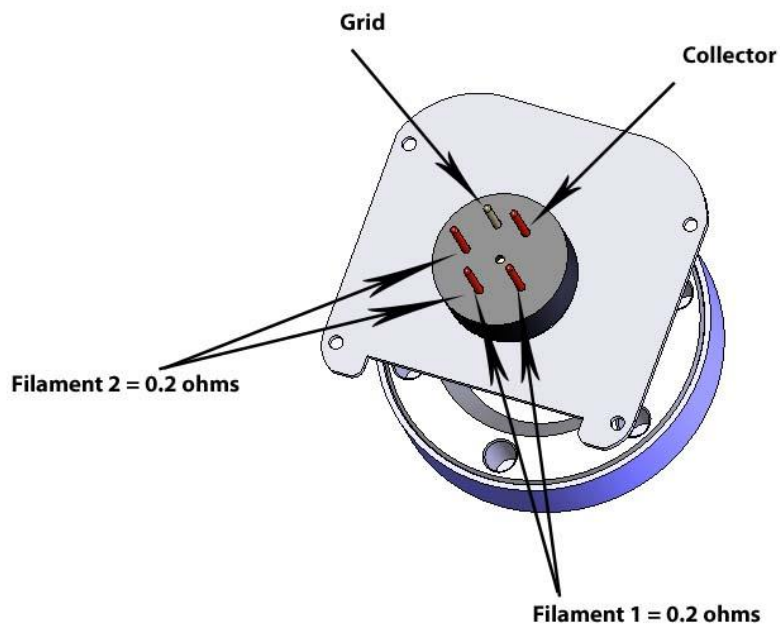

### 9.5 R & D (Research) Diagnostic Display

In addition to the normal pressure measurement screen the *IGM402* provides a diagnostic display screen that allows you to monitor the measurements of the critical electrical parameters used for measurement of very low pressures, i.e., high vacuum, made by the ionization gauge.

Over time, the hot cathode (filament) of the ionization gauge may degrade. The *IGM402* coated iridium filaments are made using yttrium oxide to lower the work function of the heated wire material and enable substantial emission of electrons from the hot cathode. These electrons are accelerated in an electric field toward the grid structure of the ionization gauge device. The electron emission is commonly referred to as the 'Emission Current'. As the emission current electrons orbit within the electric field formed by the bias voltages applied to the grid, collector and filament electrodes, the molecules that the gas is comprised of will be ionized by these energetic electrons.

The positive ions that are created within the grid structure are captured in another electric potential field created by the grid structure (at +180 Vdc with respect to ground potential) and the collector wire (at zero volts, i.e., ground potential). In simple terms, the ions collected by the collector electrode (a small diameter wire within the grid electrode structure) are measured with an electrometer circuit connected to the collector. The amount of ion current measured is directly proportional to the density of the gas within the ion gauge transducer. This ion current is commonly referred to as the 'Collector Current'.

From the collector current measured, which is directly proportional to the gas density inside the ion gauge transducer enclosure, the pressure inside the ion gauge transducer can be calculated.

The R&D display screen is a very useful diagnostic tool to troubleshoot issues with the sensor or the electronics. To access this screen, go to the SETUP DISP menu, select SHOW DATA and then select IG ONLY RND.

This mode displays the measured pressure, emission current, ion current, filament voltage and filament current. In the following example, the measured pressure is 1.00E-9 Torr, (Pressure unit is based on selected units in SETUP UNIT menu). Emission current is 4.00E-3 amperes, Ion current is 4.00E-11 amperes, filament voltage is 1.5 Vdc and filament current is 1.9 amperes.

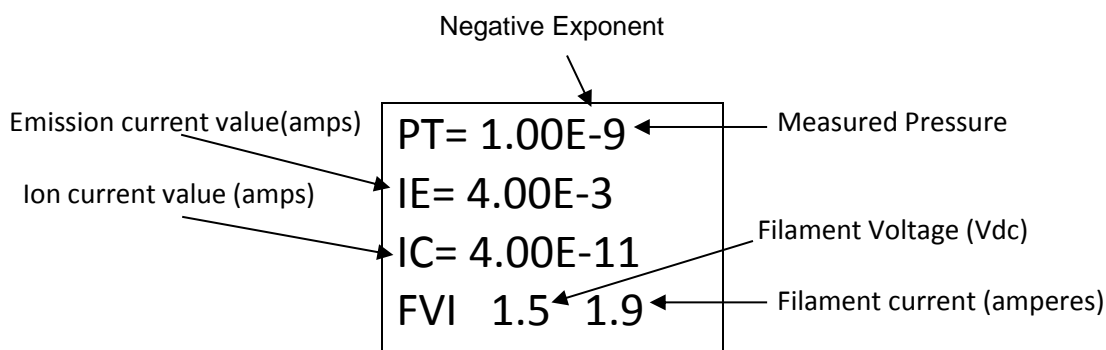

**Example - R&D Display of Critical Hot-Cathode Ion Gauge Measurement Parameters**

The Pressure, Ion Current (Collector Current) and Emission Current are indications that the ionization gauge transducer is operating and pressure (vacuum) is being measured. In the above example, most of the critical, measured quantities required for the calculation of measured pressure are displayed. The relationship of these parameters leads to the calculation of pressure given by  $P = I_C \cdot (I_E \cdot S)^{-1}$  where  $I_C$  is the Ion Current,  $I_E$  is the Emission Current and  $S$  is the sensitivity of the specific ion gauge sensor. The pressure indication may be checked by using the displayed values and calculating the pressure as indicated by the IGM402.

Other important information such as Filament Voltage and Filament Current are also given in the R&D display screen. These values vary widely dependent upon filament design type, material used for constructing the filament, filament condition and operating emission current. The product of the filament voltage and current is the power dissipation (V•A) required to maintain the set emission current. The interpretation of these displayed values is a qualitative measure. The values will change over time dependent upon the pressure, filament coating condition and possibly even surface properties of the grid electrode. It is a good practice to make note of these values at initial installation and from time-to-time during the operating lifetime of the ion gauge sensor.

A new IGM402 may operate at 100  $\mu$ A emission current with only 3 to 4 watts of power required (e.g., 1.5 V @ 2.0 A). By increasing the emission current to 4 mA, the power requirement may increase to 4 or 5 watts (e.g., 2.0V @ 2 to 2.5 A). Again, the values mentioned here are representative; the actual values you may see for the IGM402 you are using will be different and will vary over time and from device to device. In general, keeping a record of the filament heating power (given by the Filament Voltage and Filament Current readings) will aid you in monitoring the condition of your gauge filaments over time and, perhaps, give you an indication of when to schedule replacement of either the device or the filament assembly.

In cases where the ion gauge sensor does not turn ON or does not stay in the ON condition after you have made sure that the pressure is below the maximum permissible pressure for the emission current setting you have chosen, you will be able to monitor the values displayed in the **R&D** screen and determine if the turn ON / stay ON trouble is related to filament condition. There are maximum operating levels for filament voltage and current; if either of these is exceeded the IGM402 control circuitry will sense the condition and force an OFF condition.

The following table (***R & D (Research) Ion Gauge Diagnostic Display***) is intended to assist you in using the information provided in this display as a means to ascertain if the ion gauge transducer is performing as expected under your vacuum chamber operating conditions. There are various causes of trouble that at times may make it difficult to use a single measurement parameter as an indicator of what the problem is. In general, if you have monitored and recorded the values displayed in the R & D (Research) screen over time, you may be able to detect a pattern or trend that, if correlated to a particular failure mode, may prove to be a valuable indication of probable cause.

The values of filament voltage and current presented below are approximate values that one may see in the Research screen. The representative, average values used in this table may vary depending on the condition of the filament and the vacuum chamber environment. For example, you may see a reading of 2.0 V at 100  $\mu$ A emission current with a corresponding filament drive current of 2.1 A. This doesn't mean that because the voltage is higher than the value listed (1.7 V) above that there is a problem with the IG. The readings taken should be viewed with the notion that there may be an indication of reaching end-of-useful filament lifetime if the power required to sustain emission current continues to increase over time.

<b>Indication</b>	<b>Possible Cause</b>	<b>Possible Solution</b>
Filament voltage values are present for several seconds immediately after turning IG ON, but then the values are zero	Filament is contaminated or filament has reached end-of-useful operating life for required emission current setting	Switch emission current setting from initial setting and re-start the IG; make several attempts to establish emission current at both 100 $\mu$ A and 4 mA.  Switch to second filament or replace ion gauge sensor
All parameters in the R&D screen are zero after IG turn ON is attempted	Failed electronics	Replace the IGM402 electronics
IGM402 filament voltage is greater than 1.7 V and filament current is greater than 2.5 A with emission current = 100 $\mu$ A	Filament nearing end-of-useful-operating-life	Switch to second filament or replace ion gauge sensor
IGM402 filament voltage is greater than 2.3 V and filament current is greater than 2.7 A with emission current = 4 mA	Filament nearing end-of-useful-operating-life	IGM402 may be operated at either 100 $\mu$ A or 4 mA emission current setting. If trouble with maintaining 4 mA emission current ( $I_e$ ) persists, switch to 100 $\mu$ A emission current. For a marginal filament coating condition, you may have to operate the emission current at the 4 mA setting even if the maximum actual emission current is less than 4 mA. This may prevent an EMIS FAIL error that may occur when attempting to turn on the filament with emission current set at 100 $\mu$ A.

## 9.6 Maintenance

In general, maintenance is not required for your InstruTech module. Periodic performance checks may be done by comparing the gauge to a known reference standard. When using the transducer in gases containing contaminants or materials that react with the filaments of the hot cathode ion gauge, periodic degas and switching to the alternate filament from time-to-time is recommended for longest useable transducer lifetime. When the hot cathode (filament) of the ionization gauge transducer is at or near end-of-life, transducer (sensor) replacement is recommended.

## 9.7 Contamination

The most common cause of all vacuum gauge failures is contamination of the sensor. Noisy or erratic readings, and total gauge failure are all possible indications of gauge contamination.

Contamination can be generally characterized as either a reaction of process gases with sensor elements, or an accumulation of material on the sensor elements. Sensors that fail due to chemical reaction are generally not repairable. Sensors that fail due to condensation, coatings, or particles may possibly be restored by performing the degas function.

### **A) Reactive Gases**

If process gases react with the materials of construction of the sensor, the result is corrosion and disintegration of the sensor over time. For general vacuum applications, dual yttria coated filaments are offered for use with air and inert gases such as N<sub>2</sub>, argon, etc. Optional dual tungsten filaments are available for use with gases not compatible with yttria coated filaments.

### **B) Oil, Condensation, Coatings, and Particles**

If the failure is due to an accumulation of material in the gauge, you may be able to rid the gauge sensor of adsorbed gas using the degas function of the device.

Oils and hydrocarbons: Exposure of the gauge internal surfaces to oils and hydrocarbons can result in sensor contamination. Some of these types of contamination may be removed by degas. Furthermore, if there is the possibility of oil back streaming from wet vacuum pumps, it is recommended that a filter or trap be installed to prevent contamination of components of your vacuum system.

In some vacuum processes, desorbed and sputtered materials from the process may enter vacuum components connected to the process vacuum chamber by line-of-sight transport especially under high vacuum conditions, i.e., in the molecular flow regime. To prevent materials that may be transported via line-of-sight momentum from entering your vacuum gauge or other components, it is advisable to install some form of apparatus that will block the line-of-sight. In some cases a simple 90° elbow may help prevent or reduce the transport of particles from entering your vacuum gauge.

In the event of gauge contamination you can attempt to degas the sensor. If degas fails to resolve the issue, switch to second filament or replace the sensor as described in the next section.

## 9.8 Sensor Replacement

The IGM402 ion gauge module is factory calibrated for the specific ion gauge transducer (sensor) installed in it. If both filaments fail for any reason, the sensor can be replaced with a new one. The sensitivity of the new sensor must be re-programmed in the module electronics. Follow all instructions below in order to replace the sensor in the field. If you prefer, you can contact the factory for return authorization and the replacement of the sensor will be done at the factory.

To replace the sensor use the following procedure:

1. Turn off power to the IGM402.
2. Disconnect the cable from the IGM402.
3. Remove the IGM402 from the vacuum system.
4. Use a 3/32 in. size Hex key to remove the #4-40 socket head cap screws (SHCS) as shown below.
5. Detach the metal enclosure and the electronics from the sensor. Gently pull the electronics enclosure away from the sensor using a gentle rocking motion.
6. Replace sensor. Reinstall the 4-40 SHCS (4 ea.)
7. Reprogram new sensor sensitivity. The sensitivity is a value designated by the letter "S" and marked on the sensor End Plate.

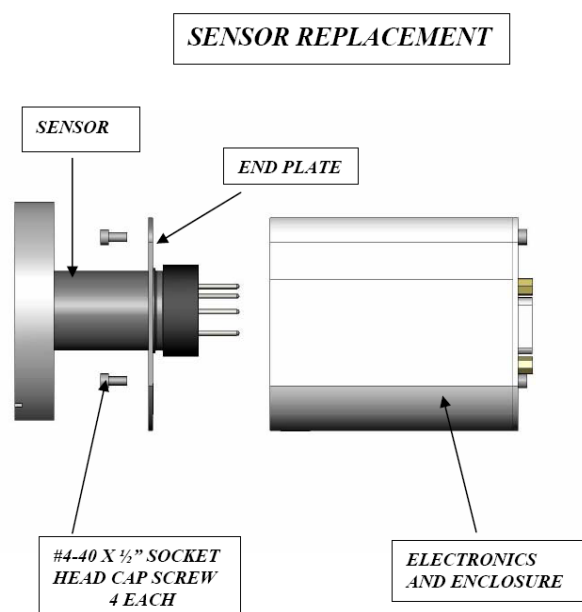



## 10 Factory Service and Support

If you need help setting up, operating, troubleshooting, or obtaining a return materials authorization number (RMA number) to return the module for diagnosis, please contact us during normal business hours (8:00am to 5:00pm Mountain time) Monday through Friday, at 303-651-0551. Or e-mail us at [support@instrutechinc.com](mailto:support@instrutechinc.com).

For the safety of our employees, you must download a material disclosure form from our website at [www.instrutechinc.com](http://www.instrutechinc.com). Please use this form to provide a history of the gauge detailing what gases have been used. We cannot perform services on products that have been exposed to hazardous materials.

## 11 Warranty

SELLER warrants that its products are free of defects in workmanship and material and fit for the uses set forth in SELLER's catalog or product specifications, under the normal use and service for which they are intended.

The entire warranty obligation of SELLER is for the repair or replacement, at SELLER's option, of products or parts (examination of which shall disclose to SELLER's satisfaction that it is defective) returned, to SELLER's plant, properly identified within eighteen (18) months after the date of shipment from InstruTech Plant. BUYER must obtain the approval of SELLER and a return authorization number prior to shipment.

Alteration or removal of serial numbers or other identification marks renders this warranty void. The warranty does not apply to products or components which have been abused, altered, operated outside of the environmental specifications of the product, improperly handled or installed, or units which have not been operated in accordance with SELLER's instructions. Furthermore the warranty does not apply to products that have been contaminated, or when the product or part is damaged during the warranty period due to causes other than ordinary wear and tear to the product including, but not limited to, accidents, transportation, neglect, misuse, use of the product for any purpose other than that for which it was designed.

THIS WARRANTY IS EXCLUSIVE AND IN LIEU OF ALL OTHER WARRANTIES, EXPRESS OR IMPLIED, INCLUDING ANY IMPLIED WARRANTY OF MERCHANTABILITY OR FITNESS FOR A PARTICULAR PURPOSE. THIS WARRANTY EXTENDS ONLY IN FAVOR OF THE ORIGINAL BUYER. THE BUYER'S SOLE REMEDY SHALL BE THE REPAIR OR REPLACEMENT, AS IS EXPRESSLY PROVIDED HEREIN, OF ANY WARRANTED DEFECTIVE PRODUCT OR PART, AND UNDER NO CIRCUMSTANCE SHALL SELLER BE LIABLE TO BUYER OR ANYONE ELSE FOR ANY CONSEQUENTIAL DAMAGES TO PERSONS OR PROPERTY, FOR INCIDENTAL DAMAGES OR LOSS OF TIME, FOR ANTICIPATED OR LOST PROFITS, OR ANY OTHER LOSS INCURRED BY THE BUYER RELATED TO THE PRODUCT COVERED BY THIS WARRANTY. THIS EXCLUSIVE REMEDY SHALL NOT BE DEEMED TO HAVE FAILED OF ITS ESSENTIAL PURPOSE SO LONG AS SELLER IS WILLING AND ABLE TO REPAIR OR REPLACE DEFECTIVE PARTS IN THE PRESCRIBED MANNER. THIS LIMITED WARRANTY MAY NOT BE MODIFIED BY SELLER UNLESS SUCH MODIFICATION OR WAIVER IS IN WRITING, EXECUTED BY AN AUTHORIZED OFFICER OF SELLER.



## **InstruTech<sup>®</sup>, Inc.**

1475 S. Fordham St.  
Longmont, CO 80503  
USA

Phone +1-303-651-0551  
Fax +1-303-678-1754  
E-mail [info@instrutechinc.com](mailto:info@instrutechinc.com)  
[www.instrutechinc.com](http://www.instrutechinc.com)