

Operating Instructions

DCU 001

DCU 100

DCU 150

DCU 200

DCU 300

DCU 600

Anzeige- und Bediengerät Display And Operating Unit

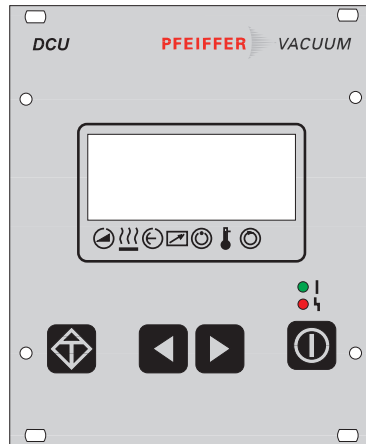

Index

	Page
1. Safety Instructions	3
2. Understanding The Control And Operating Unit DCU	4
2.1. For Your Orientation	4
2.2. Product Description	4
Mechanical Design	4
Connection Options	5
Proper Use	5
Improper Use	5
2.3. Front Panel	5
2.4. Rear Panel	6
3. Installation	7
3.1. Preparations For Installation	7
3.2. Rack Fitting	7
3.3. Connecting Diagram	7
3.4. Making The Connections	8
4. Operations	8
4.1. Short Overview, Operating	8
4.2. General	9
4.3. Switching On The DCU	9
Self-Testing	9
4.4. Functions Of The Keys	10
4.5. LC-Display	11
4.6. Symbol Definitions	12
4.7. LED Display	13
4.8. The Serial Interface	13
5. Error Codes	13
5.1. General	13
5.2. Errors During Self-Testing	13
6. What To Do In Case Of Breakdowns ?	14
7. Maintenance, Service	14
8. Technical Data	15
8.1. Data List	15
8.2. Dimensions	15
9. Supplementary Informations	16
 Manufacturer's Declaration	Appendix 1

1. Safety Instructions

- ☞ Read and follow all instructions in this manual.
- ☞ Inform yourself regarding
 - Dangers which can arise from the unit;
 - Dangers which can arise from the system;
- ☞ Follow the safety and accident prevention instructions.
- ☞ Check regularly that all safety and protection requirements are being observed.
- ☞ When installing the DCU, take account of the ambient conditions.
The protection type is IP 20. The units DCU are protected against the ingress of foreign bodies $\geq \varnothing 12$ mm. Since water protection is not provided, the unit should be mounted in a suitable housing (see Section 3. "Installation").
- ☞ Do not carry out any unauthorised modifications or alterations to the DCU.
- ☞ Do not open the housing cover when the unit is connected to the mains nor during pumping operations.
- ☞ Take account of the prescribed mains voltage values when connecting units DCU 100 to DCU 600.
- ☞ When shipping, please note the instructions in Section 7.

Pictogram definitions:



There is danger of an electric shock if the contacts are touched.



There is danger of personal injury.



There is danger of damage to the unit or to the system.

2. Understanding The Display and Operating Unit DCU

2.1. For Your Orientation

Symbols used

The following symbols will be used in the illustrations throughout the manual:

 Electrical connection

Abbreviations used

TMP = Turbomolecular Pump
DCU = Display and Operating Unit
TC = Electronic Drive Unit
TPS = Mains Power Unit

Position numbers

The same accessory parts have the same position numbers in all illustrations.

Operation instruction in the text

➔ Here, you must do something.

2.2. Product Description

The Display Control Unit DCU is an operating unit for PFEIFFER drive units. It enables control over all the main parameters of the unit. Additionally, the connection of a vacuum gauge is possible.

DCU 001 = Basic unit without mains power unit
DCU 100/150/200/300/600 = Unit with mains power unit.

Mechanical Design

The DCU is fitted in a housing suitable for mounting in a 19"/3HE rack.

Connection Options

The DCU provides the following connection options:

- Electronic drive unit for turbopump (X2)
- Pressure gauge (X3).
- Serial interface RS 485.

The units DCU 001, DCU 100 - DCU 600 have been tested and passed by the authorities in accordance with EN 61010/VDE 0411 "Safety Equipment For Electrical Units".

Proper Use

- The display and operating unit DCU may only be used to control PFEIFFER Electronic Drive Units and their peripheral units.
- Instructions concerning installation, start-up, operating and maintenance must be observed.

Improper Use

Improper is:

- Uses not covered above, especially:
 - Connection to pumps and units which is not permitted in their operating instructions.
 - Connection to units which contain touchable and voltage carrying parts.

Improper use will cause any rights regarding liability and guarantees to be forfeited.

2.3 Front panel

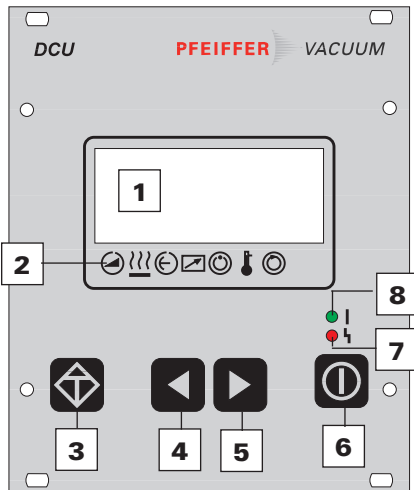

The front panel contains all the operating and display elements.

- 1 LCD display
- 2 Status display (symbol definitions see chapter 4.6.)
- 3 "Error acknowledgement" key
- 4 Key "Left"
- 5 Key "Right"
- 6 "Pumping Station ON/OFF" key
- 7 Red illuminating diode for error status
- 8 Green illuminating diode for operating status

2.4 Rear Panel

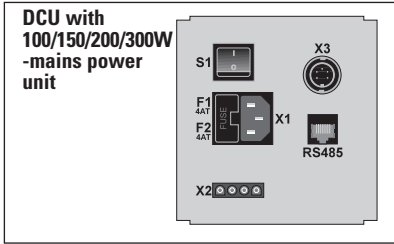

- S1 Mains switch
- F1 Mains fuse
- F2 Mains fuse
- X1 Mains connection 90-265 V~
- X2 Output for voltage supply, electronic drive unit
- X3 Pressure gauge connection
- RS 485 Communication with electronic drive unit

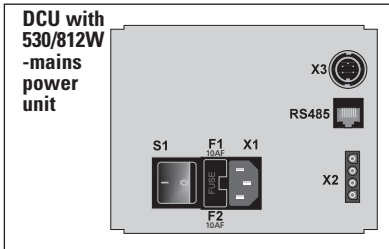

- S1 Mains switch
- F1 Mains fuse
- F2 Mains fuse
- X1 Mains connection 90-265 V~
- X2 Output for voltage supply, electronic drive unit
- X3 Pressure gauge connection
- RS 485 Communication with electronic drive unit

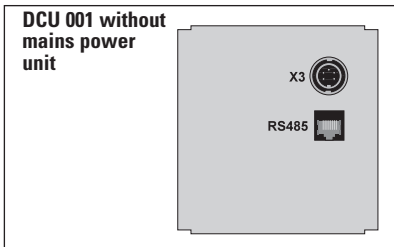

- X3 Pressure gauge connection
- RS 485 Communication with electronic drive unit

3. Installation

3.1. Preparations For Installation



Unauthorised modifications or alterations to the Display Control Unit are not allowed.

The unit must be fitted in a housing taking account of the ambient conditions (see section "Technical Data").

- ➔ Disconnect mains power plug before installation work.

Installation location: Protected against the weather.

The following is applicable for open buildings and operations rooms which are not fully air conditioned:

Temperature: +5°C - +40°C.
Relative humidity: 5 - 85%, non-condensing.
Air pressure: 86 kPa - 106 kPa

3.2. Rack Fitting

The units DCU 001, DCU 100 - DCU 600 are designed to be fitted into a 19"/3HE rack with guide rails.

- ➔ For installation secure the front panel to the rack using four fixing screws.
- ➔ Ensure free convection. The minimum distance to the upper and lower ventilation slits must be ≥ 50 mm.

The ambient temperature in the rack housing must not exceed 40°C.

Depending on the version, various connections are provided on the DCU.

3.3. Connecting Diagram

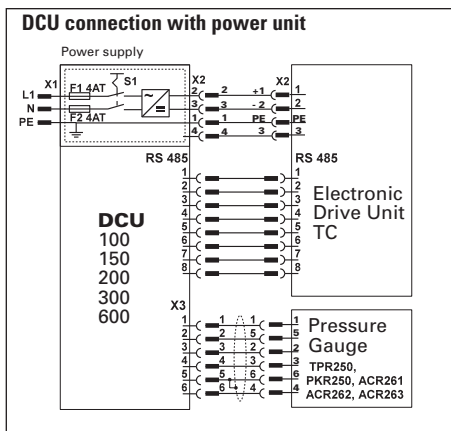
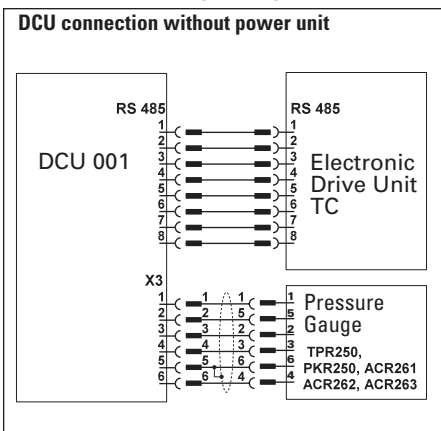

3.4. Making The Connections

- The units DCU 100 - DCU 600 have been designated protection class 1 and must always be connected with the earthed conductor (PE) via the mains cable.

Please note: If using the TC 600 electronic drive unit, please disconnect the remote plug from the RS 485 interface connection.

- ➔ Mains connection must be made in accordance with the local regulations.
- ➔ Make the connection X2 - Electronic Drive Unit in accordance with the connecting diagram, section 3.3.
- ➔ Make the connection pressure gauge to X3 as required.
- ➔ Make the connection RS 485/DCU-RS 485/Electronic Drive Unit via the delivered 8 pole cable.

The DCU 001 is re-supplied with its operating voltage via the Serial Interface RS 485 cable from the Electronic Drive Unit. As soon as this unit is switched on, the DCU is supplied with voltage.

Mains voltage

DCU 100: 90 - 265V~, 125VA

DCU 150: 90 - 265V~, 170VA

DCU 200: 90 - 265V~, 230VA

DCU 300: 90 - 265V~, 330VA

DCU 600: 90 - 132/185-265V~, 590/900VA

4. Operations

4.1. Short Overview, Operating

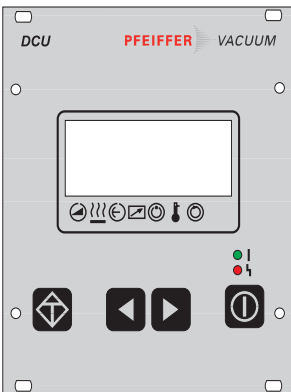

Selecting the parameters

- ➔ Select the parameter numbers with the keys ◀ (back) or ▶ (forward) (keeping the key depressed enables rapid scrolling).

Setting parameters

- ➔ Select a parameter.
 - ➔ Depress keys ◀ and ▶ simultaneously.
 - The arrow (--->) appears in the second line from the top.
 - ➔ Reduce or increase the values with the key ◀ or ▶ respectively.
 - ➔ Depress key ◀ and ▶ simultaneously.
 - The arrow (--->) disappears.
 - The parameter is set.

4.2. General

All function relevant aspects of the pump electronics are illustrated in the form of parameters. Each parameter has a number and a designation (for example, "720: Vent frequ").

The value of the parameter is always readable, in some cases also modifiable via the keyboard.

4.3. Switching On The Control Unit

➔ Make the connection to the Serial Interface RS 485.

DCU 001:

➔ Switch on the external supply of the Electronic Drive Unit (for example TPS 100-600).

DCU 100/150/200/300/600:

➔ Switch on the DCU by the switch S1 on the rear side.

➔ In the event of an error message: depress: .

Self-Testing

After switching on, the DCU performs a self-test and also a test on the connected turbo electronics. Run time of the self-test: approx. 20s. During the test a bar appears in the display in line 4 and this shows the progress of this procedure.

- **Display test:** All signs in the LC display are shown for a short time in black.
- **LED test:** During the whole testing process the red and the green LEDs illuminate.
- **DCU test:** The DCU hardware is tested.
- **Connection to the turbo electronics test:** The correct connection to the turbo electronics and their identity are examined.
- **Parameter test:** Information regarding the parameters is loaded.
- **Identification of the connected components:** The designation of the drive unit is displayed.

Providing there are no errors the DCU is now ready to operate.

4.4. Functions Of The Keys

The four keys on the front panel have the following functions:

Key	Application/Example		Explanation
			Reset (error acknowledgement). Acknowledges errors (red LED illuminates)
	—>	↵309: Act rotspd ↵310: TMP I-Mot ↵871 Hz ↵ 872 Hz	Scroll back parameters Scrolls back a parameter Reduce a value (with arrow “—>”)
	—>	↵310: TMP I-Mot ↵311: TMP Op hrs 871 Hz ↗ 872 Hz ↗	Scroll parameters forwards Scrolls forward a parameter Increases a value (with arrow “—>”)
		001: Heating ☒ off	Alters a value (⇒ data editing mode) Access to a displayed value, if possible (arrow “—>” appears)
	—>	001: Heating off ✓	Confirm a value (⇒ param. selection mode) Takes over an altered value (The arrow “—>” disappears)
	010: Pump stat. on ⇔ off		Pumping Station ON/OFF Switches the pumping station ON and OFF, equivalent to parameter 010: “Pump stat.”

4.5. LC-Display

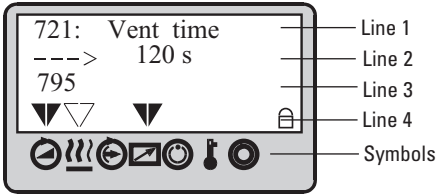

The functions are displayed via a four line LC display. A special function is assigned to each line:

- **Line 1:** Number and name of the selected parameter (for example 721: >>Vent time<<).
- **Line 2:** Relating value. If an arrow (--->) is displayed, the displayed value can be altered.
- **Line 3:** Two functions

Function 1: Messages relating to operations and operating are displayed. (see table “Operating Messages” in the operating instruction “Pumping Operations with DCU” and “Error Codes”, section 5).

Function 2: An optional second parameter in the form of >>Parameter number<< : >>value<< is displayed. The function of this line enables setting via parameter [P:795] >>Servicelin<< at line 1. With >>Servicelin<< all parameters can be displayed. Error messages are displayed independent of the selected function.

- **Line 4:** Arrows which points to the underlying symbol. This restores the unit status.







Please note:

Prolonged depressing of the key  or  enables rapid scrolling and/or alterations to the data.

The data mode (arrow “--->” is displayed) is automatically relinquished, without taking over the values to be altered, under the following conditions:

- No settings or key depressing for longer than 10 seconds.
- The occurrence of an error.
- The key  has been depressed.

4.6. Symbol Definitions

	Symbol	Arrow	Explanation
	Pump	–	No
	accelerates	▼	yes
	Pre-selection	–	No pre-selection
	heating	▽	Pre-selection heating, but switchpoint not attained
		▼	Heating ON, switchpoint attained
	Stand-by	–	Off
		▼	On
	Unit under remote control	–	No
		▼	Yes
	Switchpoint attained	–	No
		▼	Yes
	Excess-temperature	–	No excess temperatures
		▽	Excess temperature pump
		▽	Excess temperature pump elektronik
		▼	Excess temperature pump and pump elektronik
	Final rotation speed attained	–	No
		▼	Yes

4.7. LED Display

The red LED (error status) and green LED (operations status) on the front panel can take on the following conditions:

Red LED

Illuminates: Collective error messages
Flashes: Warning

Green LED

Illuminates: Mains power unit OK, pumping station ON
Flashes: Mains power unit OK, pumping station OFF
Blinks: Mains power failure

4.8. Serial Interface

The serial Interface RS 485 is only used for connecting the pump controller at the vacuum pump. The description of the interface protocol you can find in the operating instruction PM 800 488 BN.

5. Error Codes

5.1. General

Errors ("Errxxx" or "Error Exxx") always causes to shut-down of the TMP, the fan, the heating and the backing pump.

- ➔ After the error is removed depress key .
→ The unit is again ready to operate.

Warnings ("Wrnxxx" or "Warning Fxxx") are only displayed and do not cause components to be shut down.

5.2. Errors During Self-Testing

The following errors can occur during self-testing performed when the DCU is switched on:

Display	Error	Possible action
** Error E021 **	• Wrong pump identification resistance	Mains OFF-ON Inform PFEIFFER-Service
** Error E040 **	• Hardware error: external RAM defective	Inform PFEIFFER-Service
** Error E042 **	• Hardware error: EPROM checksum	Inform PFEIFFER-Service
** Error E090 **	• Insufficient RAM • The DCU is connected to the wrong pump electronic	Inform PFEIFFER-Service Connect correct pump electronic
** Error E698 **	• The connected drive unit does not respond	Check communication lead between electronic drive unit and DCU, switch on electronic drive unit

6. What To Do In Case of Breakdowns ?

Check the fuses

In case of an error:

- ➔ Loosen F1/F2 with a screwdriver and check fuses. Replace if defective. Only use fuses with high switching capability.

The safety values are stated on the rear panel of the DCU.

7. Maintenance And Service

The unit requires no maintenance. A damp cloth can be used to wipe away any dirt which has collected on the front panel. Ensure that the unit is first disconnected from the mains power supply.

Do Make Use Of Our Service Facilities

In the event that repairs are necessary a number of options are available to you to ensure any system down time is kept to a minimum:

- Have the unit repaired on the spot by PFEIFFER Service Engineers;
- Return the unit to the manufacturer for repairs;
- Replace with a new value unit.

Local PFEIFFER representatives can provide full details.



When carrying out their own repairs customers must bear in mind that dangerous voltage levels are present.

Please note:

Units returned to us for repair or maintenance are covered by our general conditions of sale and supply.

Contact addresses and telephone hotline:

Please refer to the back cover of this manual for contact addresses and telephone hotline numbers.

8. Technical Data

8.1. Data List

Definition	Unit	DCU 001	DCU 100	DCU 150	DCU 200	DCU 300	DCU 600
Connection voltage:	V DC	12-30 ¹⁾	–	–	–	–	–
	V AC	–	90-132	90-132	90-132	90-132	90-132
	V AC	–	185-265	185-265	185-265	185-265	185-265
Frequency:	Hz	–	50-60	50-60	50-60	50-60	50-60
Max. power consumption.:	VA	≤ 5	≤ 125	≤ 170	≤ 230	≤ 350	590/900 ²⁾
Output voltage X2:	VDC	–	24	24	48	72	140
Max output current X2:	A	–	4,1/4,6 ²⁾	5/6,2 ²⁾	4,1/4,6 ²⁾	3,2/4,2 ²⁾	3,8/5,8 ²⁾
Max output power X2.:	W	–	100/110 ²⁾	120/150 ²⁾	200/220 ²⁾	230/300 ²⁾	530/812 ²⁾
perm. amb. temperature.:	°C	5 - 40					
Max. relative humidity. ³⁾	%	5 - 85					
Air pressure:		86kPa - 106 kPa					
Protection type:		IP 20					
Weight:	kg	0,4	1,6	1,9	1,9	2,2	2,6

1) only supplied by PFEIFFER Electronic Drive Unit
 2) at 90-132 V AC / 185-265 V AC
 3) non condensing

8.2. Dimesions

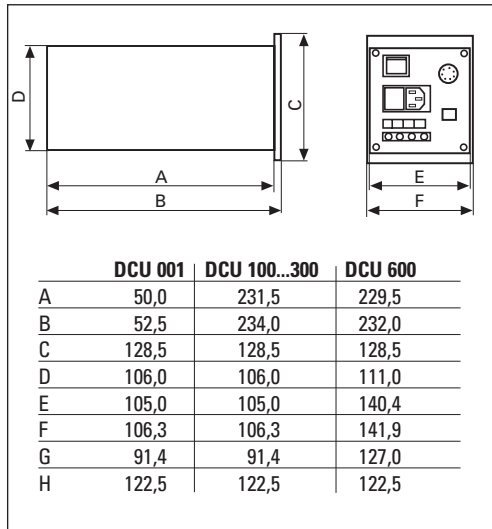
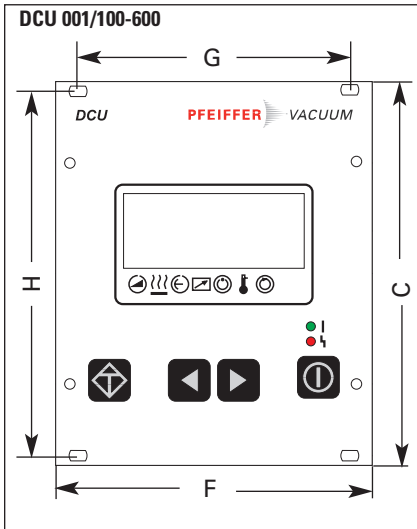

9. Supplementary Information

The Display And Control Unit DCU is a universal component for the control and monitoring of PFEIFFER vacuum pumps and drive units.

Depending on the configuration of your components further operating instructions are included in the delivery consignment (please see the table). If, despite every effort by us, information on your products is missing please get in touch with your local Pfeiffer representatives or call us on the hotline shown on the back cover page. All operating instructions are also available as PDF files.

The following operating instructions are available for the range of pumps which come with DCU control units:

Product	Definition	No. Operating Instruction
Vacuum pump	Description of the Pump	dependent to the pump typ ¹⁾
DCU 001, 100-600	Description of the controller	PM 800 477 BD
Operating turbo pump with DCU	Operating definition/parameter	PM 800 547 BD
TPS 100, 200, 300, 600	Description of the mains power unit	PM 800 521 BD
Housing heating turbo pump	Description of the housing heating	PM 800 542 BD
Air cooling turbo pump	Description of the air cooling	PM 800 543 BD
Water cooling turbopump	Description of the water cooling	PM 800 546 BD
Backing pump relay box ²⁾	Description monitoring of the backing p.	PM 800 544 BD
Temperature Management System TMS	Description heating of the pre vacuum section of the turbo pump	PM 800 570 BD
RS 232/RS 485	Description of the interface	PM 800 488 BD
Level converter RS 232/RS 485	Pump monitoring via RS 232	PM 800 549 BD
TVF 005	Description of the vent valve	PM 800 507 BD

¹⁾ Numbers can be supplied by PFEIFFER Service.

²⁾ Only for rotary vane vacuum pumps.

CE **Konformitätserklärung** **CE**
Declaration of Conformity

im Sinne folgender EU-Richtlinien:
pursuant to the following EU directives:

- **Elektromagnetische Verträglichkeit/***Electromagnetic Compatibility* **89/336/EWG**
- **Niederspannung/***Low Voltage* **73/23/EWG**

Wir bestätigen Konformität mit der EU-Richtlinie über elektromagnetische Verträglichkeit 89/336/EWG und der EU-Niederspannungsrichtlinie 73/23/EWG.

We hereby certify that the product specified below is in accordance with the provision of EU Electromagnetic Compatibility Directive 89/336/EEC and EU Low Voltage Directive 73/23/EEC.

Produkt/*Product:*
DCU 001, DCU 100, DCU 200, DCU 300, DCU 600

Angewendete Richtlinien, harmonisierte Normen und angewendete, nationale Normen:
Guidelines, harmonised standards, national standards in which have been applied:

EN 61010, EN 55011, EN 50081-1, EN 50082-2, IEC 801 1-4, VDE 0843-6

Unterschrift/*Signature:*



Pfeiffer-Vacuum GmbH
Emmeliusstrasse 33
35614 Asslar
Germany

(W. Dondorf)
Geschäftsführer
Managing Director

Konf.II/2000

Zentrale/Headquarters

Pfeiffer Vacuum GmbH

Berliner Strasse 43
D-35614 Asslar

Telefon 06441/802-0

Telefax 06441/802-202

Hotline 06441/802-333

<http://www.pfeiffer-vacuum.de>

Argentina

ARO S.A., Av. Belgrano 369,
1092 Buenos Aires, telephone +54 / 11 4331 5766,
telefax +54 / 11 4331 3572

Australia

Scitech Australia Pty. Ltd., Suite 1B,
10-18 Cliff Street, Milsons Point, NSW 2061,
telephone +61 / 2 9954 1925, telefax +61 / 2 9954 1939

Austria

Pfeiffer Vacuum Austria GmbH
Diefenbachgasse 35, A-1150 Wien,
telephone +43 / 1 8941 704, telefax +43 / 1 8941 707
Service Hotline: +43 / 1 8941704

Branch Office, Czech Republic

Pfeiffer Vacuum Austria GmbH, Branch Prague
Zvonarska 885
CZ-156 00 Praha 5
telephone +420/2 900 42981, telefax +420/2 579 23014

Belgium / Luxemburg

Pfeiffer Vacuum Belgium N.V./S.A.
Luxemburgstraat 5, B-9140 Temse
telephone +32 / 3 710 5920, telefax +32 / 3 710 5929
Service Hotline: +32 / 3 710 5922

Brazil

Emi Tec
Assistencia Técnica e Representação S/C Ltda.
Rua Bernardino de Campos, 551-Brooklin
CEP 04620-002 São Paulo, SP - Brasil
telephone +55 / 11 5532 0740, telefax +55 / 11 5535 3598

Chile

BERMAT S.A., Coyancura 2283, Oficina 601
Providencia, P.O. Box 9781, Santiago
telephone +56 / 2 231 8877, telefax +56 / 2 231 4294

Colombia

Arotex Colombiana S.A., Carrera 15 No.38-17
P.O. Box 050 862, Santafe de Bogota / D.C.
telephone +57 / 1 288 7799, telefax +57 / 1 285 3604

Denmark

Pfeiffer Vacuum Scandinavia AB, Vesterengen 2,
DK-2630 Taastrup,
telephone +45 / 43 52 38 00, telefax +45 / 43 52 38 50

France

Pfeiffer Vacuum France SAS
45, rue Senouque, BP 139
F-78531 BUC Cedex
telephone +33 / (0)1 30 83 04 00
telefax +33 / (0)1 30 83 04 04

Germany

Pfeiffer Vacuum GmbH,
Berliner Strasse 33, D-35614 Asslar
telephone +49 / 6441 802 400, telefax +49 / 6441 802 399
Service Hotline: +49 / 6441 802 333

Great Britain

Pfeiffer Vacuum Ltd.
2-4 Cromwell Business Centre
Howard Way, Interchange Park
Newport Pagnell, MK16 9QS, United Kingdom
telephone +44 / 1 908 500615, telefax +44 / 1 908 500616

Greece

Analytical Instruments S.A., 1 Mantzarou St.,
GR-15451 Athens,
telephone +30 / 1 674 8973, telefax +30 / 1 674 8978

Hong Kong

Pfeiffer Vacuum Asia Ltd.
Units 06-07, 17/F, Workingfield Commercial Building,
408-412 Jaffe Road, Hong Kong
telephone +852 2575 6688, telefax +852 2575 6993

India

Pfeiffer Vacuum India Ltd.
25-E Nicholson Road, Tarbunde
Secunderabad 500 009,
telephone +91 / 40 775 0014, telefax +91 / 40 775 7774

Israel

ODEM Scientific Applications Ltd.
9 Hamazera St., P.O.B. 2001 Nes Ziona
telephone +972 8 938 0333, telefax +972 8 938 0334

Italy

Pfeiffer Vacuum Italia S.p.a.
Via San Martino, 44 1-20017 RHO (Milano)
telephone +39 / 2 93 99 051, telefax +39 / 2 93 99 05 33

Japan

Hakuto Co. Ltd., C.P.O. Box 25,
Vacuum Scientific Instruments Division
C.P.O. Box 25, Tokyo 100-91
telephone +81 / 3 32 258 910, telefax +81 / 3 32 259 011

Korea

Pfeiffer Vacuum Korea Ltd.,
703 Ho, 853-1, Hankuk Mulru, Dongchonri, Suzi-Eup,
449-843 Yong-in City, Kyungkido
telephone +82 / 31 266 0741, telefax +82 / 31 266 0747

Netherlands

Pfeiffer Vacuum Nederland BV
Veldzigt 30a, NL-3454 PW De Meern,
telephone +31 / 30 6666050, telefax +31 / 30 6662794

Peru

Ing. E. Brammertz s.r.l., José Pardo 182,
Apartado 173, PE-18 Miraflores,
telephone +51 / 1 445 8176, telefax +51 / 1 445-1931

Poland

Softtrade Sp.z.o.o, ul. Grunwaldzka 391,
PL-80-173 Poznan, telephone +48 / 61 8677 168,
telefax +48 / 61 8677 111

Portugal

Unilaser Lda, Taguspark
Núcleo Central, sala n° 268, Estrada Cacém-
Porto Salvo, P-2780 Oeiras
telephone +351 / 1 421 7733, telefax +351 / 1 421 7744

Singapore

APP Systems Services Pte. Ltd, 2 Corporation Road
06-14 Corporation Place, Singapore 618494,
telephone +65 / 268 2024, telefax +65 / 268 6621

Spain

Tecnovac
Tecnología de Vacío S.L., Ronda de Poniente, 6 Bajo F,
Centro Empresarial Euronova,
E-28760 Tres Cantos (Madrid)
telephone +34 / 91 804 11 34, telefax +34 / 91 804 30 91

Sweden

Pfeiffer Vacuum Scandinavia AB
Johanneslundsvägen 3
S-194 61 Upplands Väsby
telephone +46 / 590 748 10, telefax +46 / 590 748 88

Switzerland

Pfeiffer Vacuum Schweiz S.A.
Föhrliibuckstraße 30, CH-8005 Zürich
telephone +41 / 1 444 2255, telefax +41 / 1 444 2266

South Africa

Labotec Pty Ltd., P.O. Box 6553,
Halfway House
1685 Midrand
telephone +27 / 11 315 5434, telefax +27 / 11 315 5882

Taiwan

HAKUTO Taiwan Ltd. Hsinchu office No. 103,
Hsien Chen 11th Street, Chupei,
HsinChu County, Taiwan, R.O.C.
(zip/postal code: 302)
telephone +886 / 3 554 1020, telefax +886 / 3 554 0867

Thailand

Hakuto (Thailand) Ltd.
18th Floor, Chokchai Intil Bldg.
690 Sukhumvit Road
Klongton, Klongtoey
Bangkok 10110
telephone +662 / 259 6244, telefax +662 / 259 6243

U.S.A.

Pfeiffer Vacuum, Inc.
24 Trafalgar Square
Nashua, NH 03063-1988
USA
telephone +1/ 603 578 6500, telefax +1/ 603 578 6500

Venezuela

Secotec S.A., Apartado 3452, Caracas 1010-A,
telephone +58 / 212 573 8687
telefax +58 / 212 573 1932

Other countries

AVI - Applied Vacuum Industries GmbH
Leginglenstrasse 17A; CH-7320 Sargans
Switzerland
telephone +41 / 81 710 03 80
telefax +41 / 81 710 03 81

Scope of represented countries

Armenia, Azerbaijan, Bangladesh, Belarus, Bulgaria,
Cambodia, Estonia, Georgia, Kazakhstan, Kingdom of
Nepal, Kirghizia, Latvia, Lithuania, Maldiva,
Philippines, P.R. China, Rumania, Russia, Tajikistan,
Turkmenistan, Ukraine, Uzbekistan, Vietnam

A.E.M.S.

Advanced Equipment Materials and Systems
P.O. Box 25
Föhrenweg 18
FL-9496 Balzers
telephone +423/ 380 0550
telefax +423/ 380 0551

Scope of represented countries

Bahrain, Egypt, Iraq, Iran, Jordan, Kuwait, Lebanon,
Lybia, Oman, Pakistan, Saudi-Arabia, Sudan, Syria,
Turkey, United Arab Emirates, Yemen