

Lecture 15

Electron Energy Loss Spectroscopy

EELS

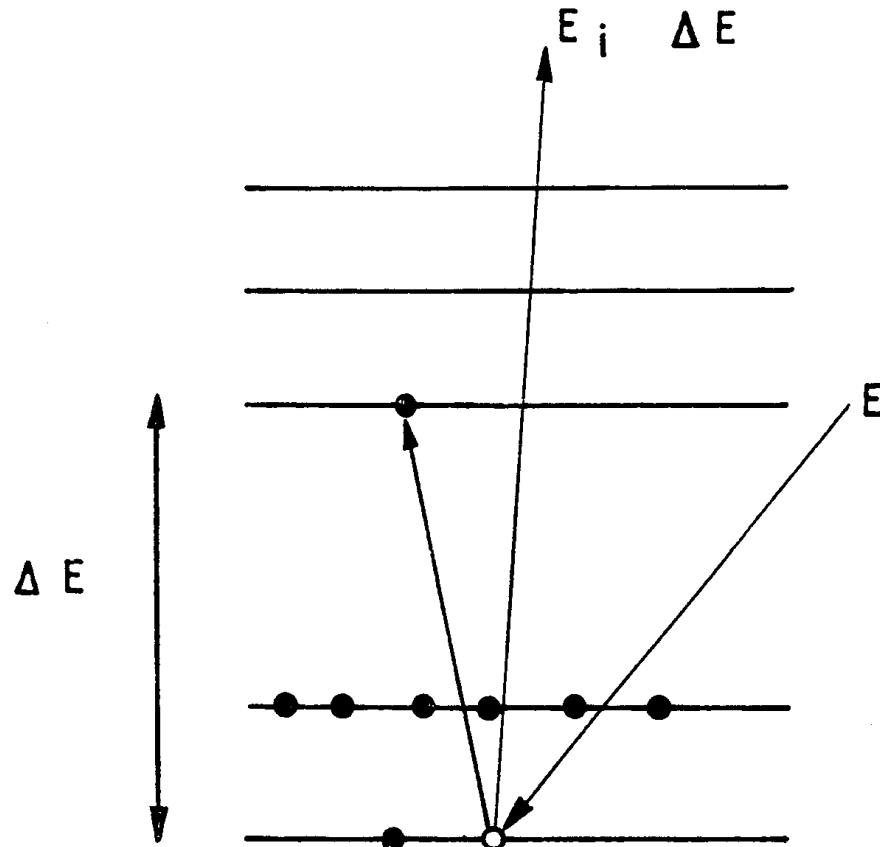

Electron Energy Loss Spectroscopy

Electron Impact Spectroscopy

Inelastic Electron Scattering



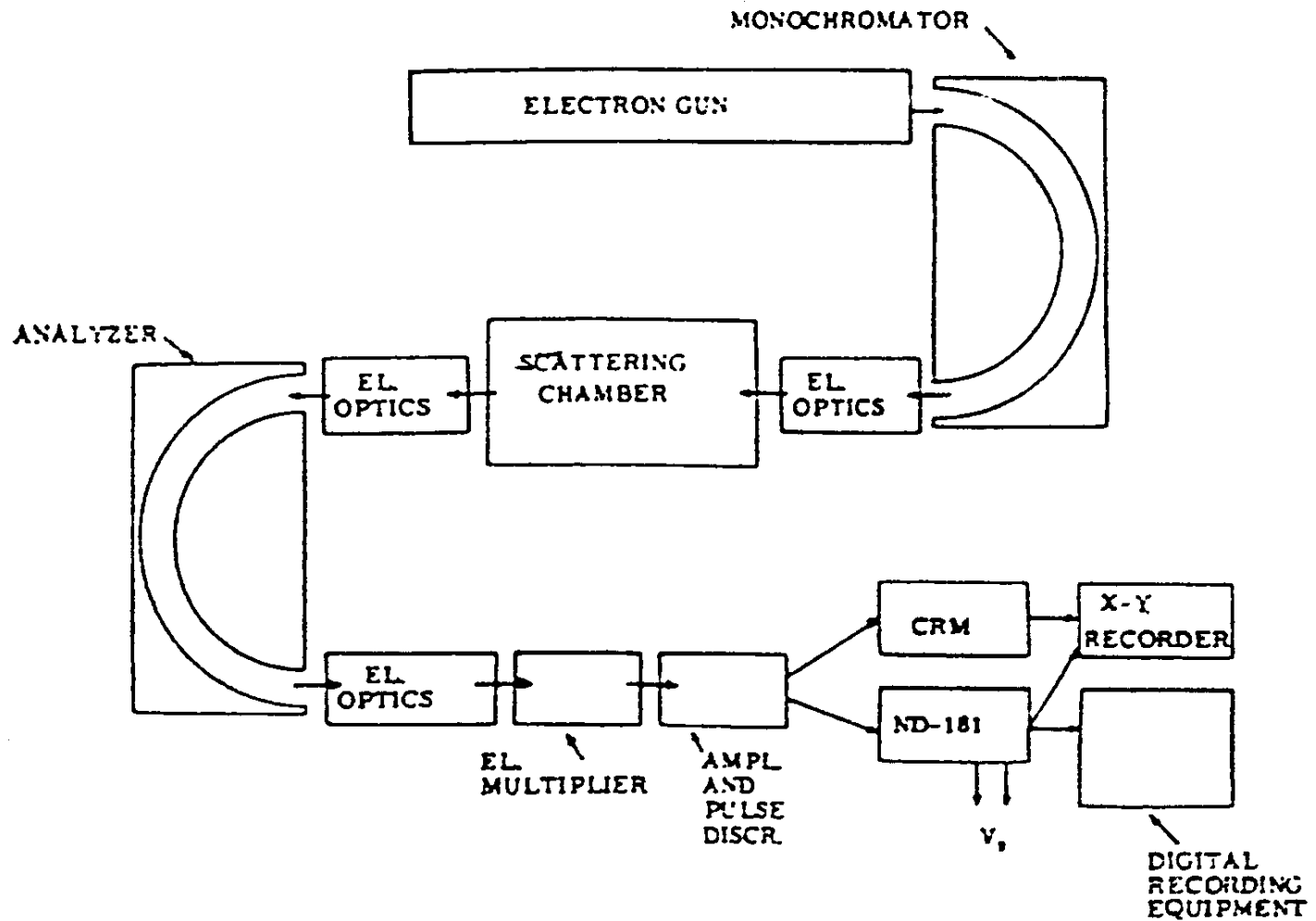

Schematic diagram of the electron-impact spectrometer.

Electron Energy Loss Spectroscopy EELS

I. EELS of molecules

Valence transitions

core transitions

EELS

$E_{\text{ex}} < 100\text{eV}$

Resolution

$\sim 30\text{ meV}$

ISEELS Res $\approx 100\text{ meV}$

$E_{\text{ex}} \approx \text{keV}$

II. High resolution EELS or HREELS

For Surfaces

$E_{\text{ex}} \sim \text{eV}$

Res $\sim 3\text{-}10\text{ meV}$

Best $\sim 1.8\text{ meV} = 14.5\text{cm}^{-1}$

EELS of molecules

Complementary to optical spectroscopy with several advantages over optical methods.

Light/molecule interaction is electromagnetic.

Electron/molecule is also electromagnetic.

Major component in this is coulombic

Electron/molecule collisions occur at large distances and electrons suffer only small deviations from their original path

Angular distribution will be forward peaked.

These transitions are similar to optical ones.

Differences occur when the impact energy is comparable to excitation energy.

1. Electron exchange

singlet \rightarrow triplet

great cross section enhancement

isotropic scattering

2. Polarization

symmetry forbidden

complex angular distribution

How to determine such transitions?

1. Angular dependence

2. Impact energy dependence

Other low energy electron impact spectroscopy

Threshold excitation spectroscopy

Neutral and negative ion states

Resonances in the integral cross sections

Due to $-ve$ ion formation

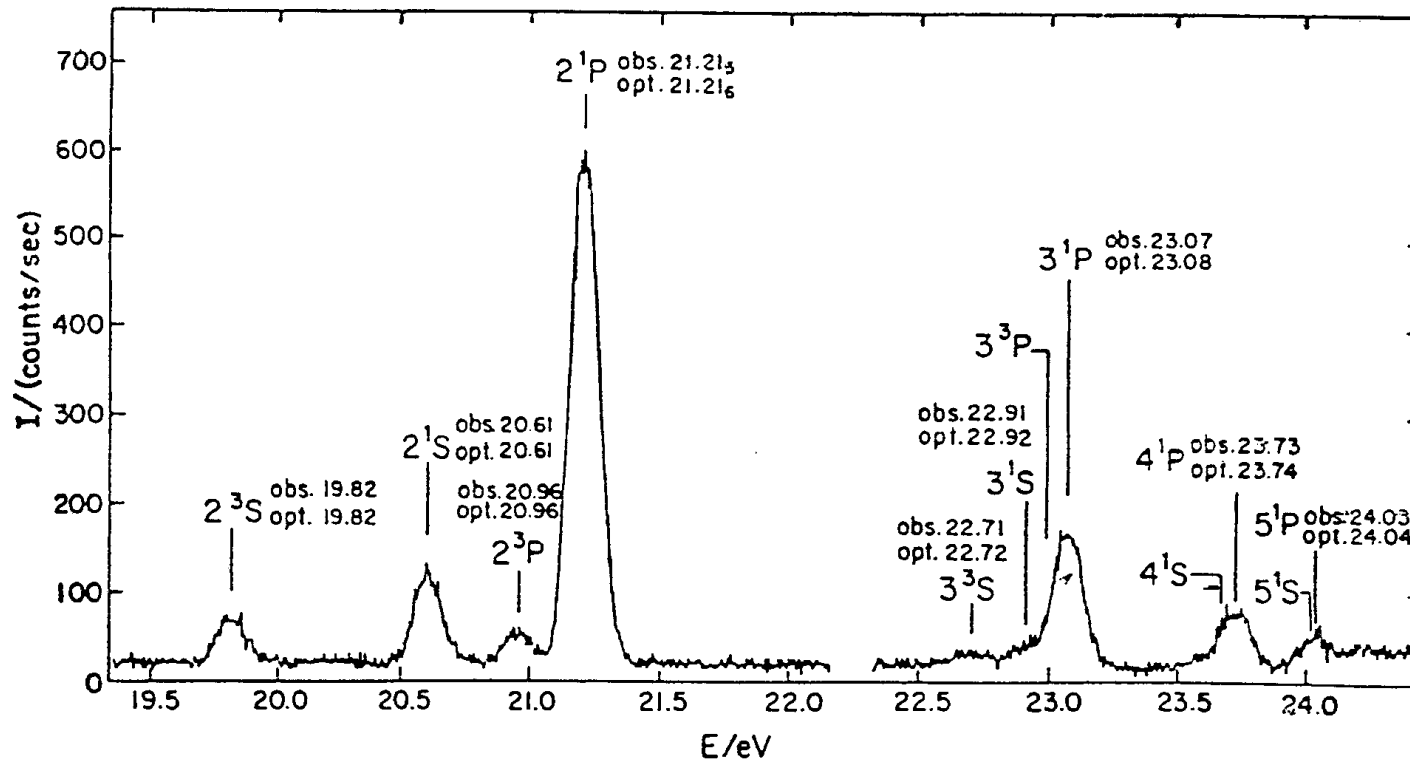

Electron energy-loss spectrum of helium; 35-eV incident electron energy; 25° scattering angle; torr pressure gauge reading; 4×10^{-9} A incident beam current; 0.15-eV resolution (FWHM of the elastic multichannel scaler mode-single sweep-with a voltage step of 5 mV/channel and a scan rate of 2 sec/channel).

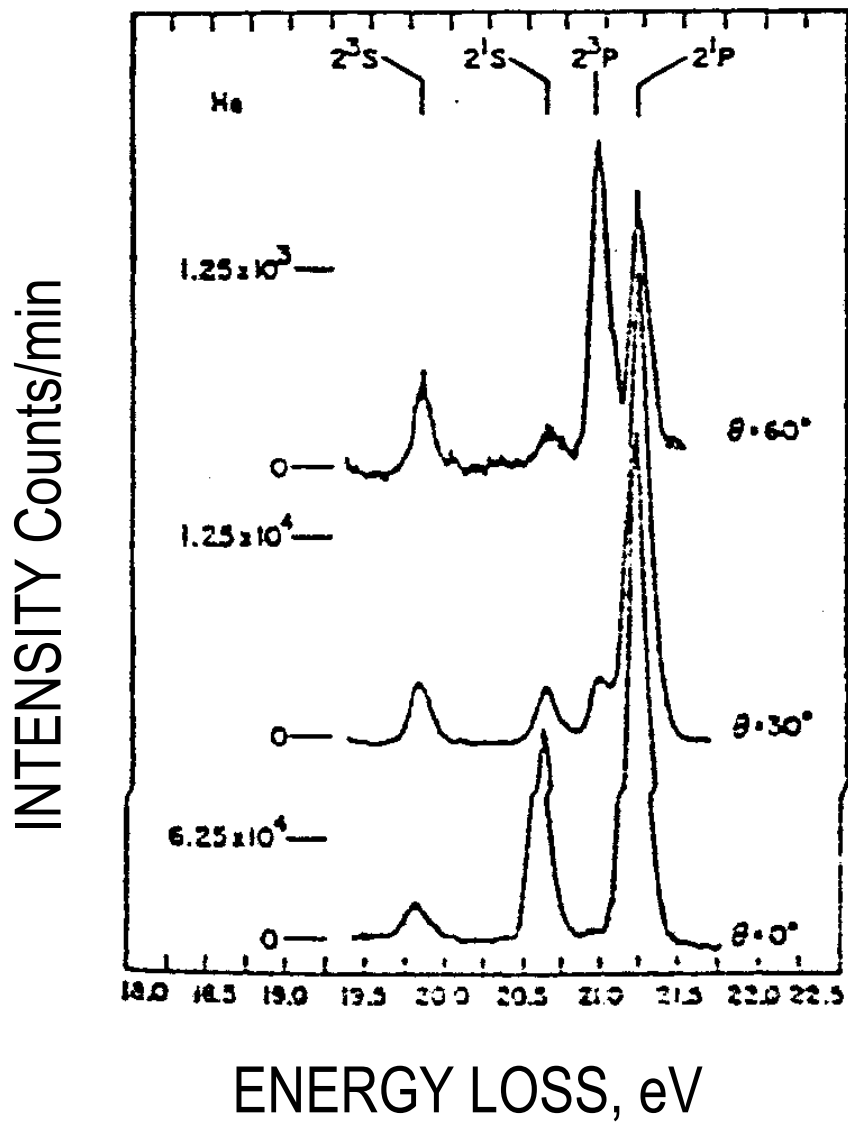

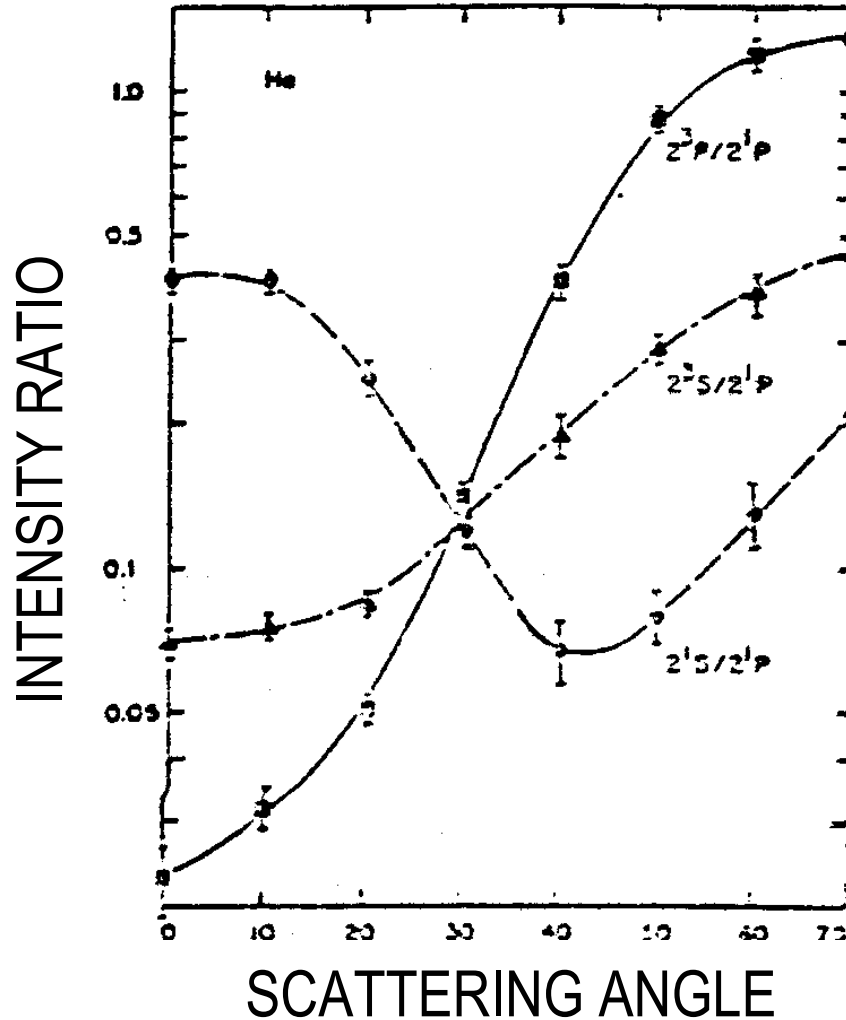

Peak intensity as a function of scattering angle for the three lowest transitions in helium with respect to that of the $1^1S \rightarrow 2^1P$ transition.

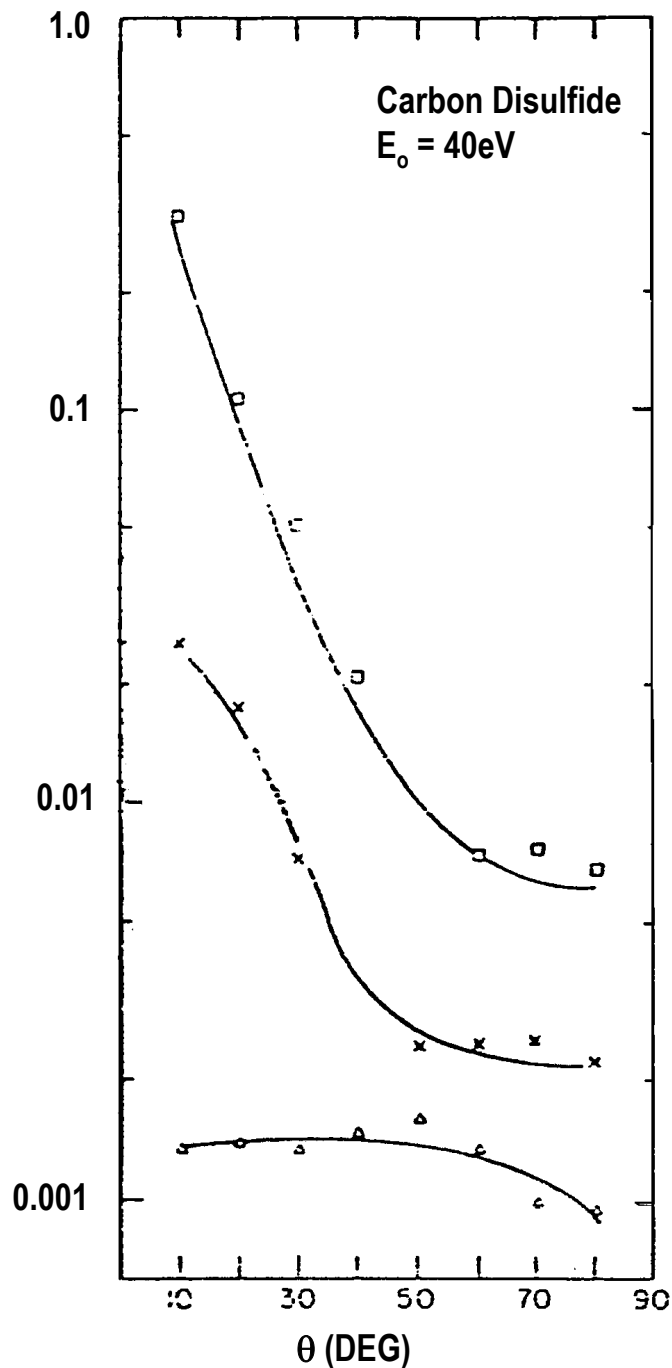

Differential cross sections (DCS) for three kinds of electronic transitions in carbon disulfide, As a function of scattering angle (θ), or an incident electron energy (E_0) of 40 eV. The arbitrary units in the ordinate are the same for all transitions. The One at 6.27 eV energy loss is optically allowed, the one at 3.91 eV energy loss is spin-allowed but symmetry-forbidden, and the one at 3.36eV is spin-forbidden. Scale factors are numbers by Which DCS values were multiplied before being Plotted.

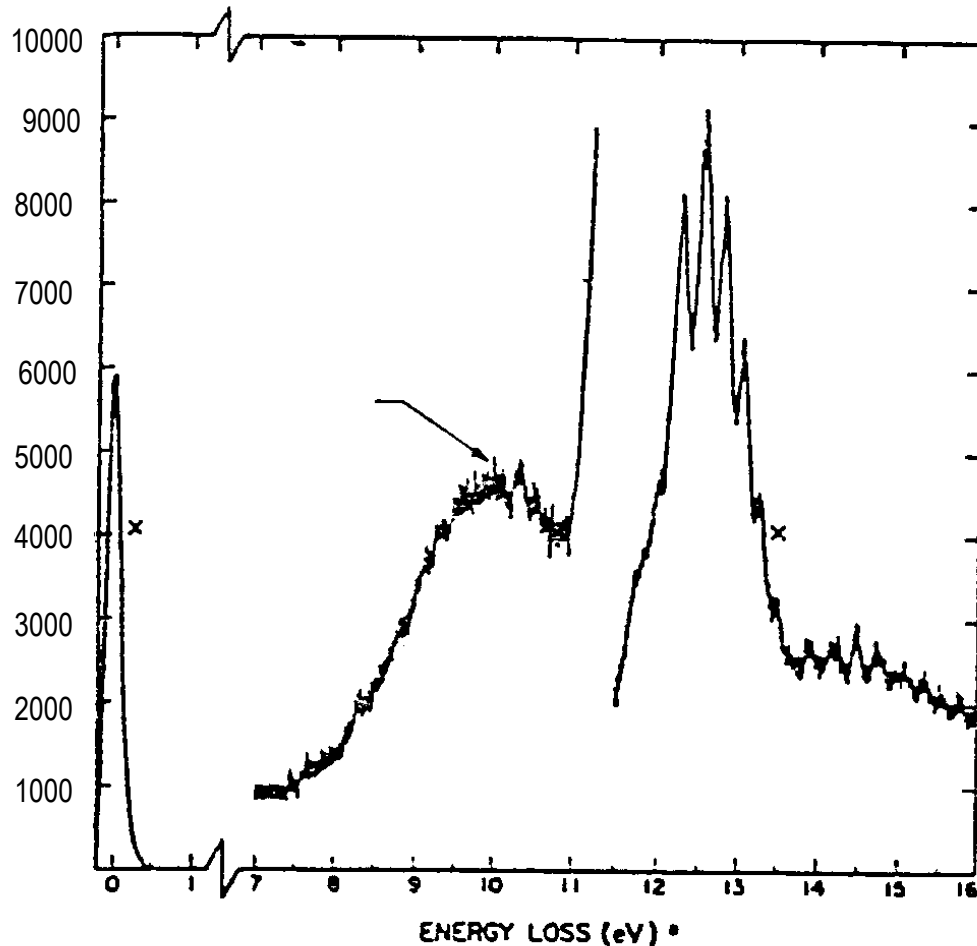

Electron energy-loss spectrum of molecular hydrogen; 50-eV incident electron energy; 40° scattering angle; 2×10^{-2} torr pressure; 2.8×10^{-3} A Incident current; 0.20-eV resolution; rate meter mode.

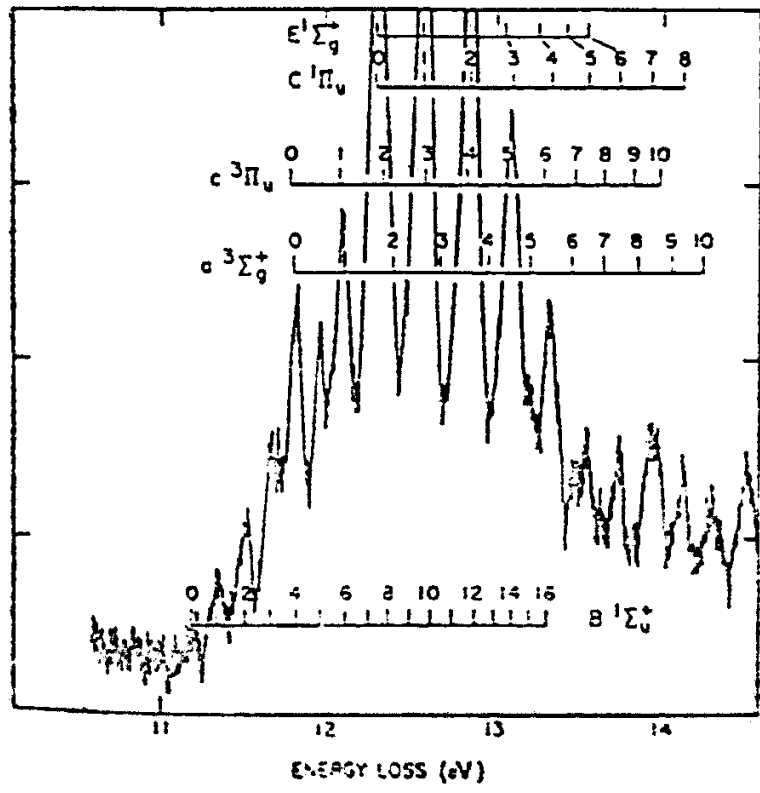

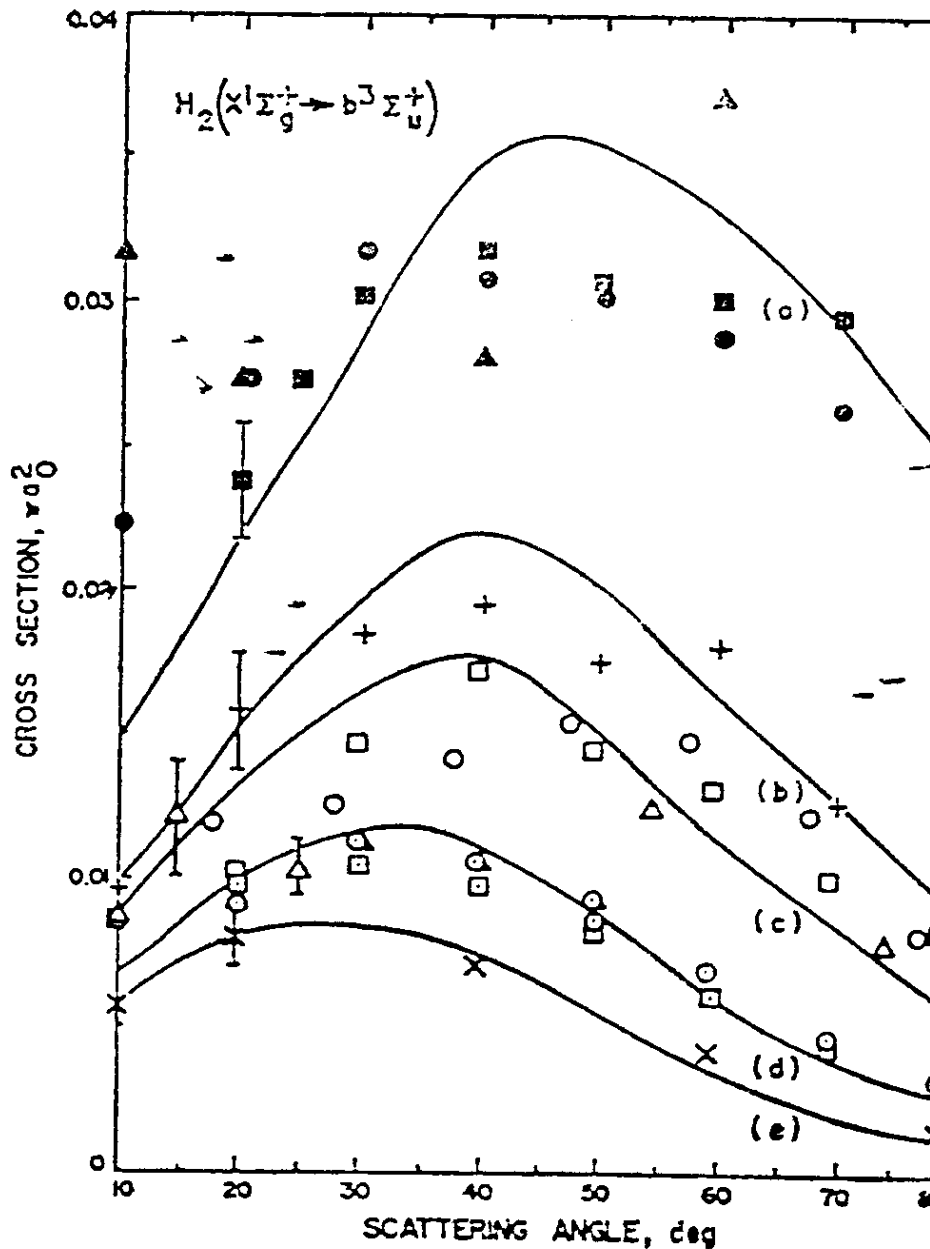

Differential scattering cross sections for the transition $X^1\Sigma_x^+ \rightarrow b^2\Sigma_u^+$ in molecular hydrogen as a function of angle at (a) 25-eV, (b) 35-eV, (c) 40-eV, (d) 50-eV, and (e) 60-eV impact energies. The solid curves are calculated values and the discrete points are experimentally determined

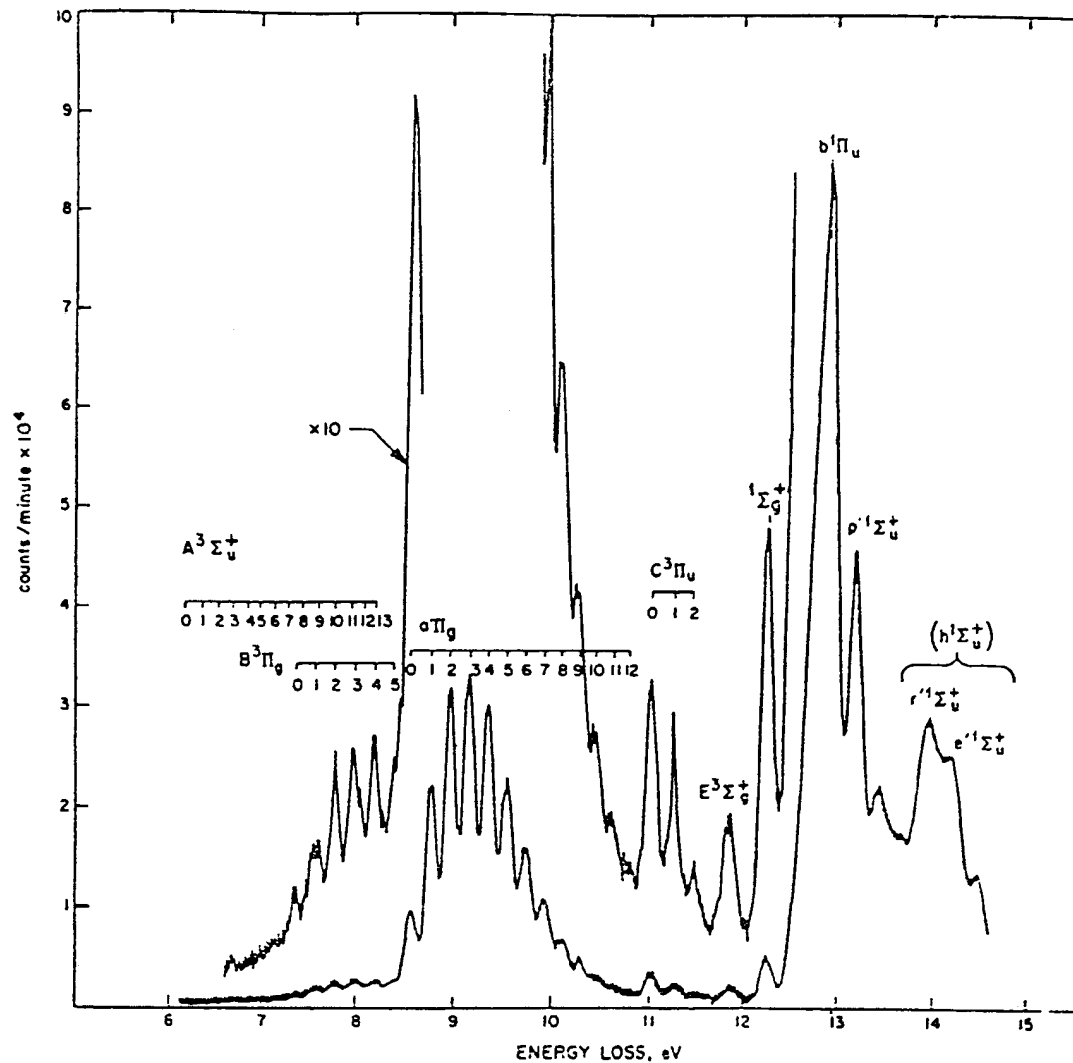

Electron energy-loss spectrum of nitrogen; 40-eV impact energy; 20° scattering angle; 10⁻² torr pressure; rate meter mode.

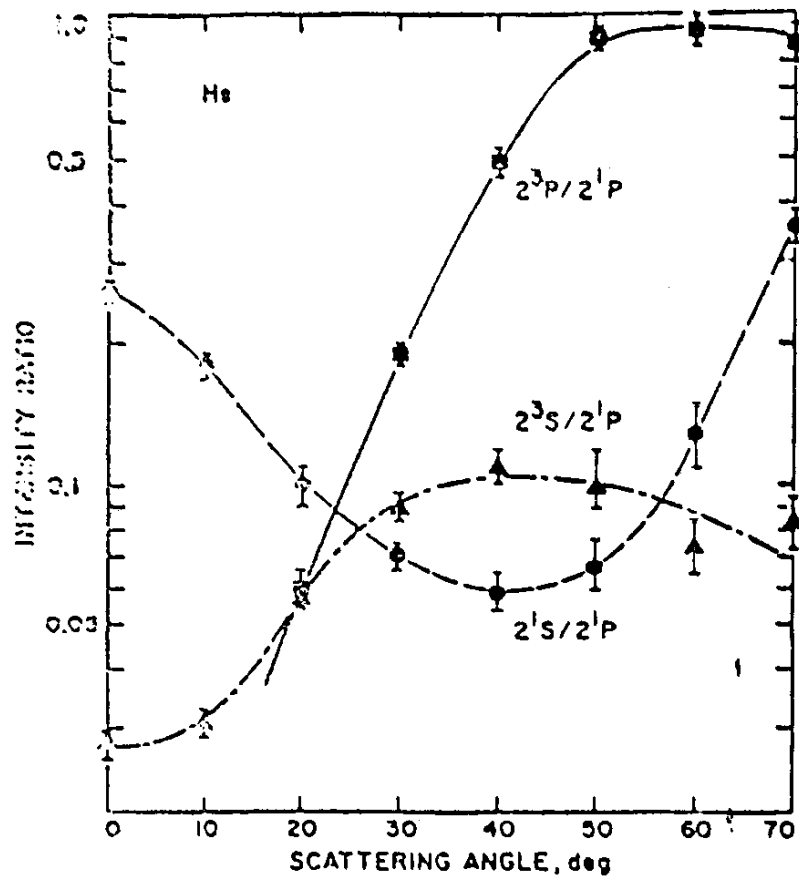

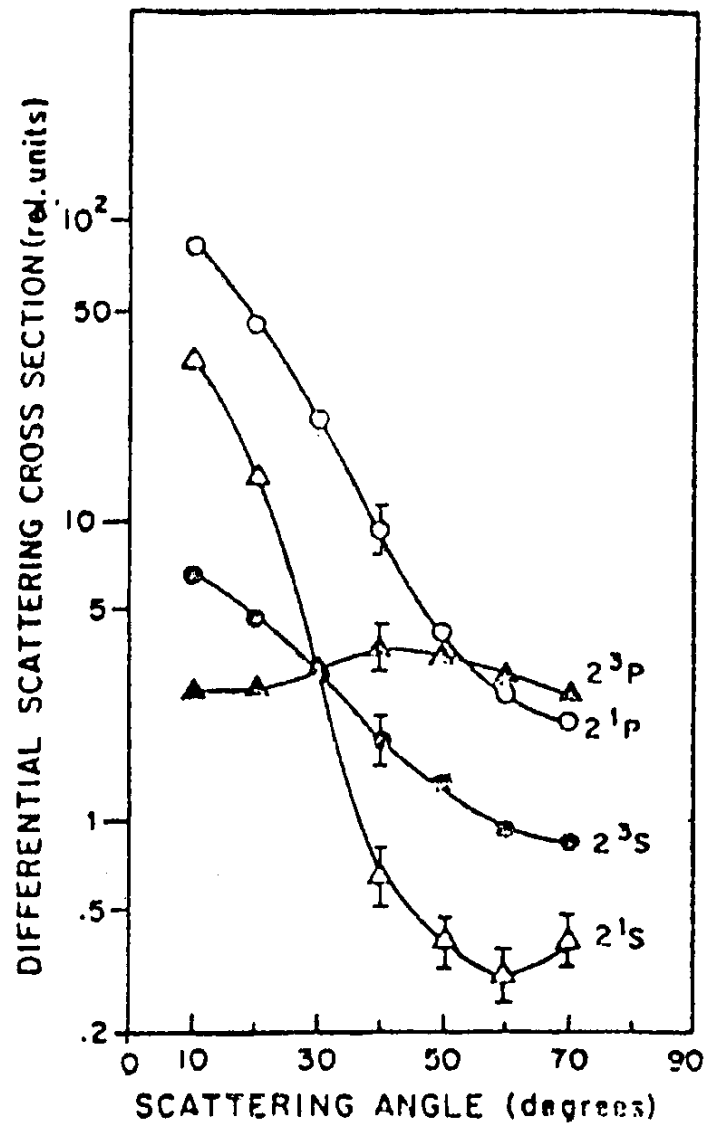

Core shell spectroscopy

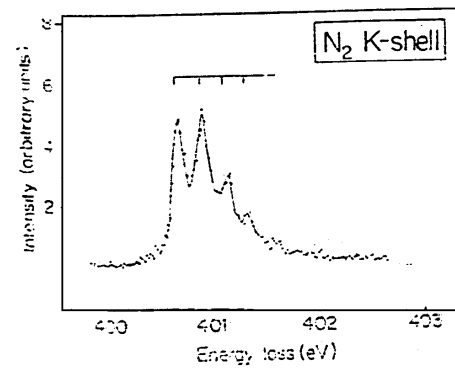
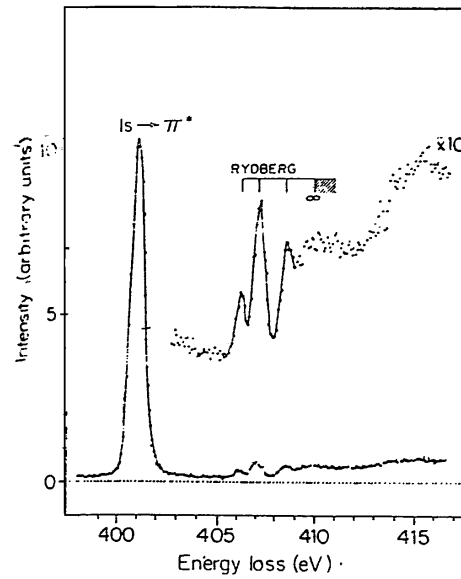

Molecular States: Complete Information

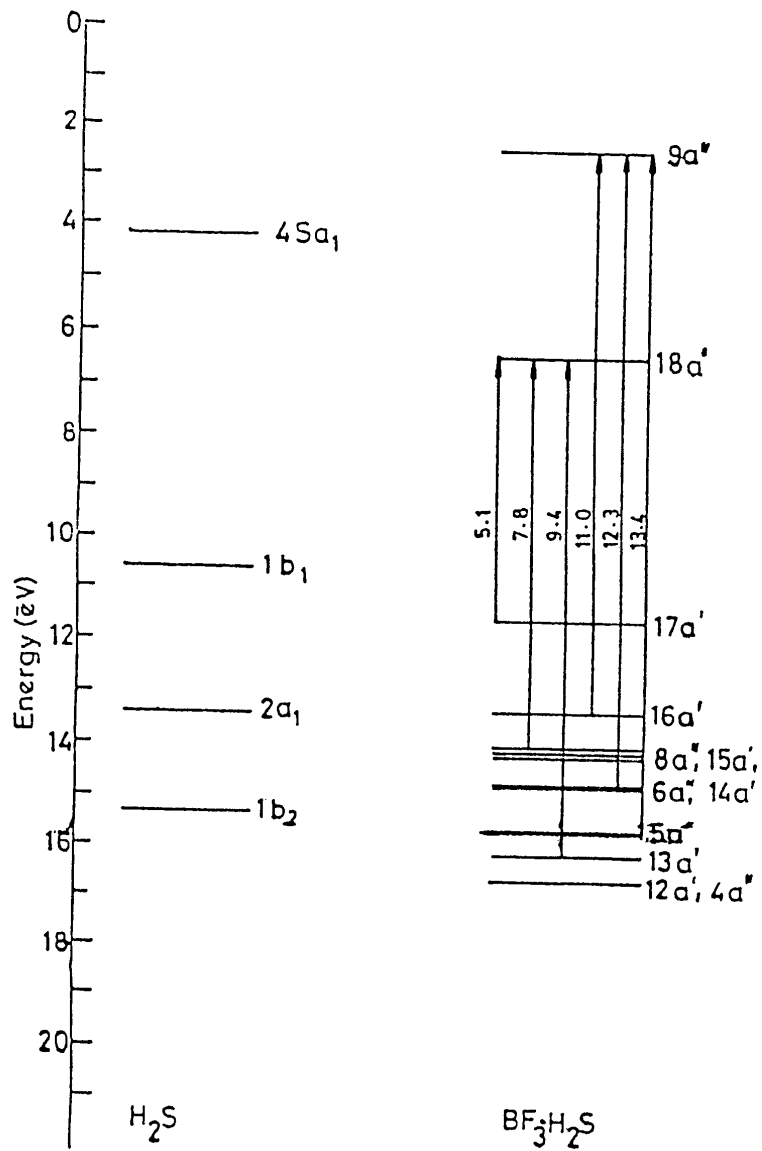

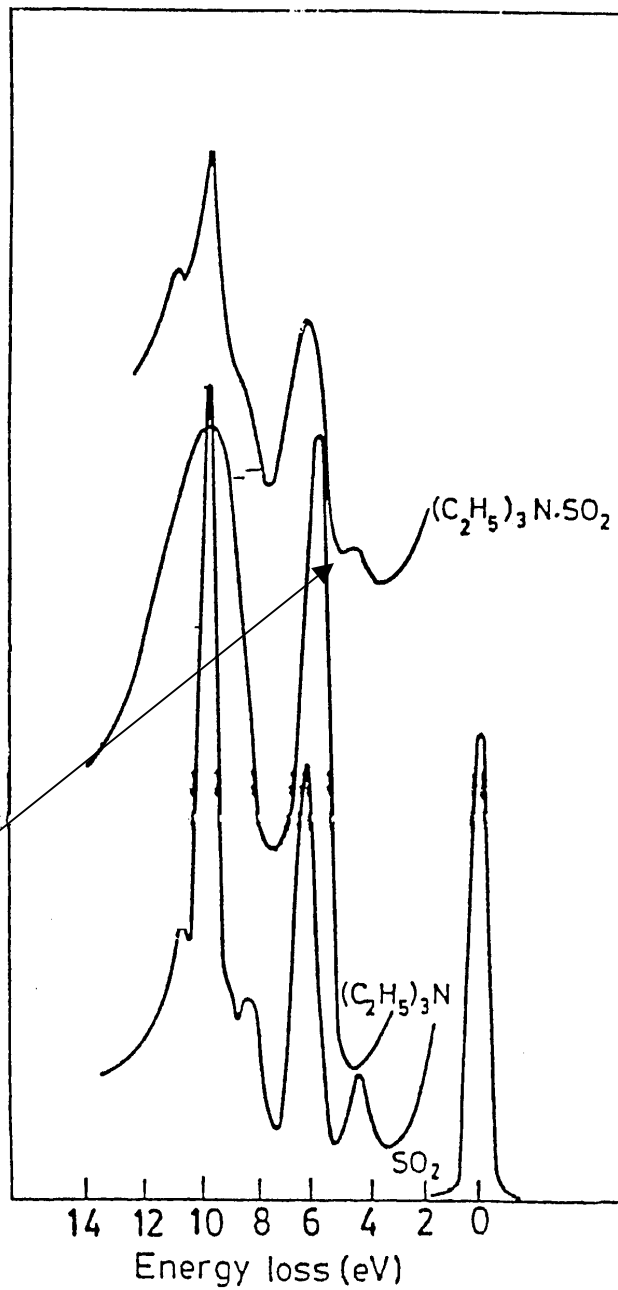

Charge-Transfer

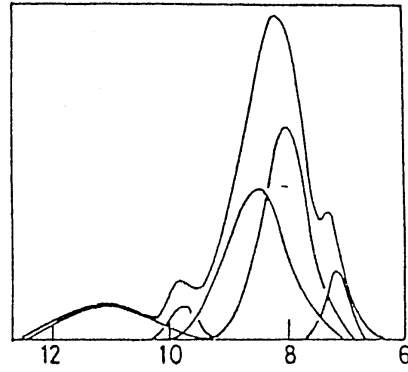

Energy loss (eV)

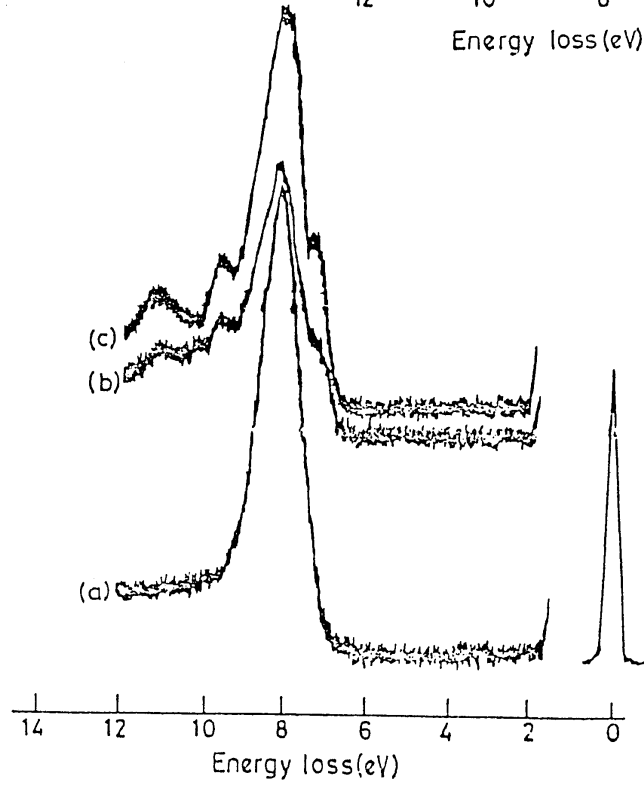

Energy loss (eV)